



HF/50 MHz TRANSCEIVER

FTDX5000 SERIES

Technical Supplement

©2011 VERTEX STANDARD CO., LTD.

EH036H90C

VERTEX STANDARD CO., LTD.

4-8-8 Nakameguro, Meguro-Ku, Tokyo 153-8644, Japan

VERTEX STANDARD

US Headquarters

10900 Walker Street, Cypress, CA 90630, U.S.A.

YAESU UK LTD.

Unit 12, Sun Valley Business Park, Winnall Close
Winchester, Hampshire, SO23 0LB, U.K.

VERTEX STANDARD HK LTD.

Unit 1306-1308, 13F., Millennium City 2, 378 Kwun Tong Road,
Kwun Tong, Kowloon, Hong Kong

VERTEX STANDARD (AUSTRALIA) PTY., LTD.

Tally Ho Business Park, 10 Wesley Court, East Burwood, VIC, 3151



Introduction

This manual provides technical information necessary for servicing the FTDX5000 Series HF/50 MHz Transceiver.

Servicing this equipment requires expertise in handling surface-mount chip components. Attempts by non-qualified persons to service this equipment may result in permanent damage not covered by the warranty, and may be illegal in some countries.

Two PCB layout diagrams are provided for each double-sided circuit board in the Transceiver. Each side of is referred to by the type of the majority of components installed on that side ("leaded" or "chip-only"). In most cases one side has only chip components, and the other has either a mixture of both chip and leaded components (trimmers, coils, electrolytic capacitors, ICs, etc.), or leaded components only.

While we believe the technical information in this manual to be correct, VERTEX STANDARD assumes no liability for damage that may occur as a result of typographical or other errors that may be present. Your cooperation in pointing out any inconsistencies in the technical information would be appreciated.

Important Note

- 1) This transceiver was assembled using Pb (lead) free solder, based on the RoHS specification.
Only lead-free solder (Alloy Composition: Sn-3.0Ag-0.5Cu) should be used for repairs performed on this apparatus. The solder stated above utilizes the alloy composition required for compliance with the lead-free specification, and any solder with the above alloy composition may be used.
- 2) Risk of explosion if battery is replaced by an incorrect type.
Dispose of used batteries according to the instructions.

Contents

Specifications

Exploded View & Miscellaneous Parts

Block Diagram

Connection Diagram

Alignment

Board Unit (Schematics, Layouts & Parts)

TRX Unit

VRF Unit

BPF Unit

SCP Unit

DVS Unit

RX-1 Unit

LOCAL Unit

CNTL Unit

PA-B Unit

TUNER Unit

TUNER-C Unit

ANT Unit

VRF-A Unit

DSP Unit

VR-A Unit

VR-B Unit

ENC Unit

BACK-LIGHT Unit

SW-A Unit

SW-B Unit

SW-C Unit

SW-D Unit

JACK Unit

MIC Unit

UEL Unit

LINK Unit

Specifications

General

Rx Frequency Range:	30 kHz - 60 MHz (operating)* 1.8 - 29.7 MHz, 50 - 54 MHz (specified performance, Amateur bands only)*
Tx Frequency Ranges:	1.8 - 29.7 MHz, 50 - 54 MHz (Amateur bands only) 5.16750MHz, 5.33200MHz, 5.34800MHz, 5.36800MHz, 5.37300MHz, 5.40500MHz (USA version only)
Frequency Stability:	±0.05 ppm (MP version, after 1 minute @+14 °F ~ +140 °F [-10 °C ~ +60 °C]) ±0.5 ppm (after 1 minute @+14 °F ~ +140 °F [-10 °C ~ +60 °C])
Operating Temperature Range:	+14 °F ~ +140 °F (-10 °C ~ +60 °C)
Emission Modes:	A1A (CW), A3E (AM), J3E (LSB, USB), F3E (FM), F1B (RTTY), F1D (PACKET), F2D (PACKET)
Frequency Steps:	1/5/10 Hz (SSB,CW, & AM), 100 Hz (FM)
Antenna Impedance:	50 Ohms, unbalanced 16.7 - 150 Ohms, unbalanced (Tuner ON, 1.8 - 29.7 MHz Amateur bands) 25 - 100 Ohms, unbalanced (Tuner ON, 50 MHz Amateur band)
Power Consumption:	Rx (no signal) 70 VA Rx (signal present) 80 VA Tx (200 W) 720 VA
Supply Voltage:	AC 90 V - AC 264 V
Dimensions (WxHxD):	18.2" x 5.3" x 15.3" (462 x 135 x 389 mm) w/o knob and connector
Weight (approx.):	46.3 lbs (21 kg)

Transmitter

Power Output:	10 - 200 watts (CW, LSB, USB, FM, RTTY, PKT) 5 - 50 watts (AM carrier) 10 - 75 watts (Class A: LSB, USB)
Modulation Types:	J3E (SSB): Balanced, A3E (AM): Low-Level (Early Stage) F3E (FM): Variable Reactance
Maximum FM Deviation:	±5.0 kHz/±2.5 kHz
Harmonic Radiation:	Better than -60 dB (1.8 - 50 MHz Amateur bands)
SSB Carrier Suppression:	At least 60 dB below peak output
Undesired Sideband Suppression:	At least 60 dB below peak output
Audio Response (SSB):	Not more than -6 dB from 300 to 2700 Hz
3rd-order IMD:	-31 dB @14 MHz, 100 watts PEP -40 dB @14 MHz, Class A: 75 watts PEP
Bandwidth:	500 Hz (CW) 3.0 kHz (LSB, USB) 6.0 kHz (AM) 16 kHz (FM)
Microphone Impedance:	600 Ohms (200 to 10 k Ohms)

Specifications

Note

Exploded View

Case ASSY

REF.	VXSTD P/N	Description	Qty.
①	U31406007	OVAL HEAD SCREW M4X6B	10
②	U31306007	OVAL HEAD SCREW M3X6B	23
③	U24306001	BIND HEAD TAPTITE-B M3X6	15
④	U34308001	FLAT HEAD TAPTITE-B M3X8	10
⑤	U03306002	SEMS SCREW ASM3X6NI	1
⑥	U20304002	BINDING HEAD SCREW M3X4NI	3
⑦	U9900254	SPECIAL SCREW M4X20B	2
⑧	U24410007	BIND HEAD TAPTITE-B M4X10B	2

Non-designated parts are available only as part of a designated assembly.

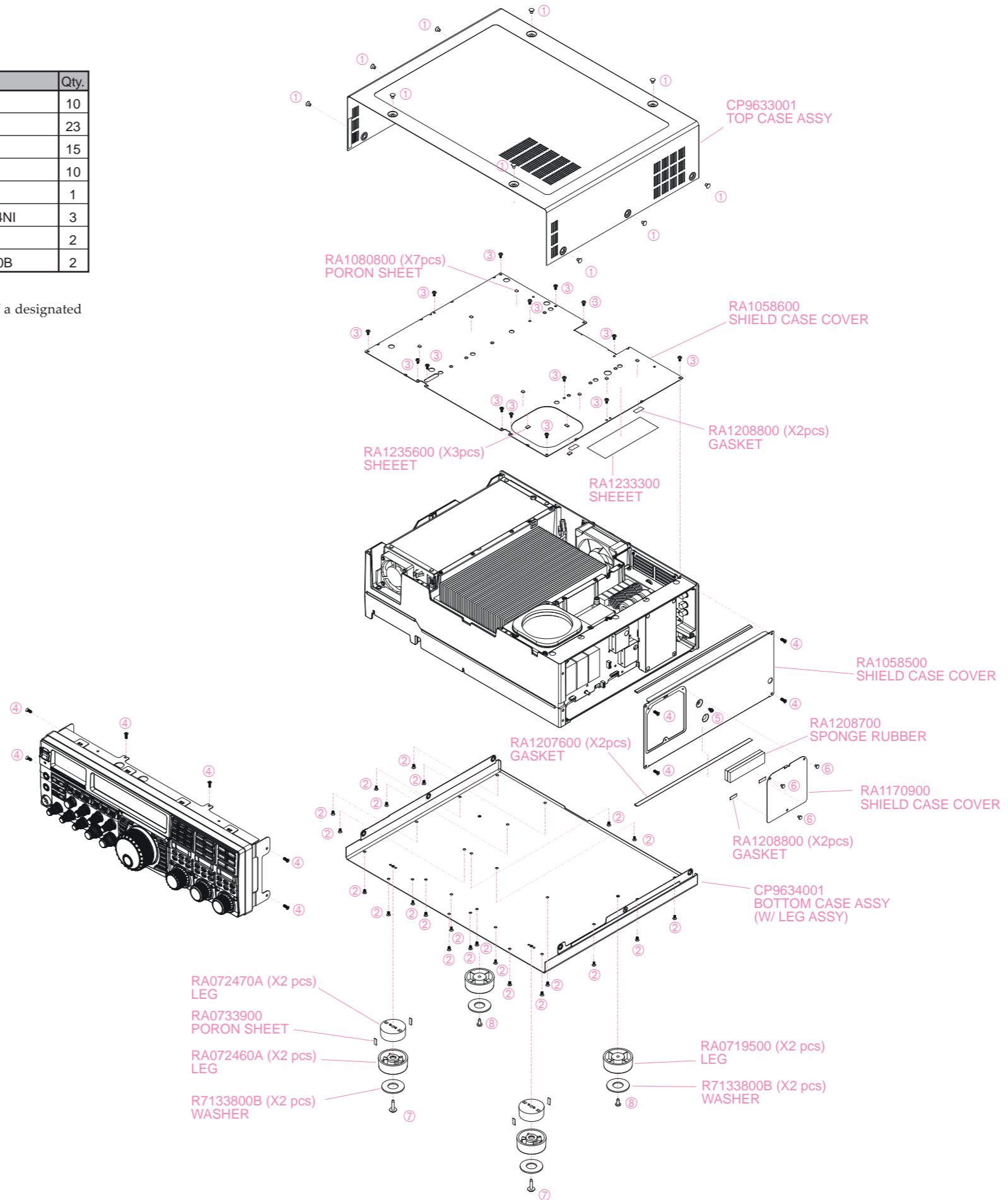

Exploded View

Panel ASSY (1/2)

REF.	VXSTD P/N	Description	Qty.
①	U24208001	BIND HEAD TAPTITE-B M2.6X8	5
②	U03306002	SEMS SCREW ASM3X6NI	4

Non-designated parts are available only as part of a designated assembly.

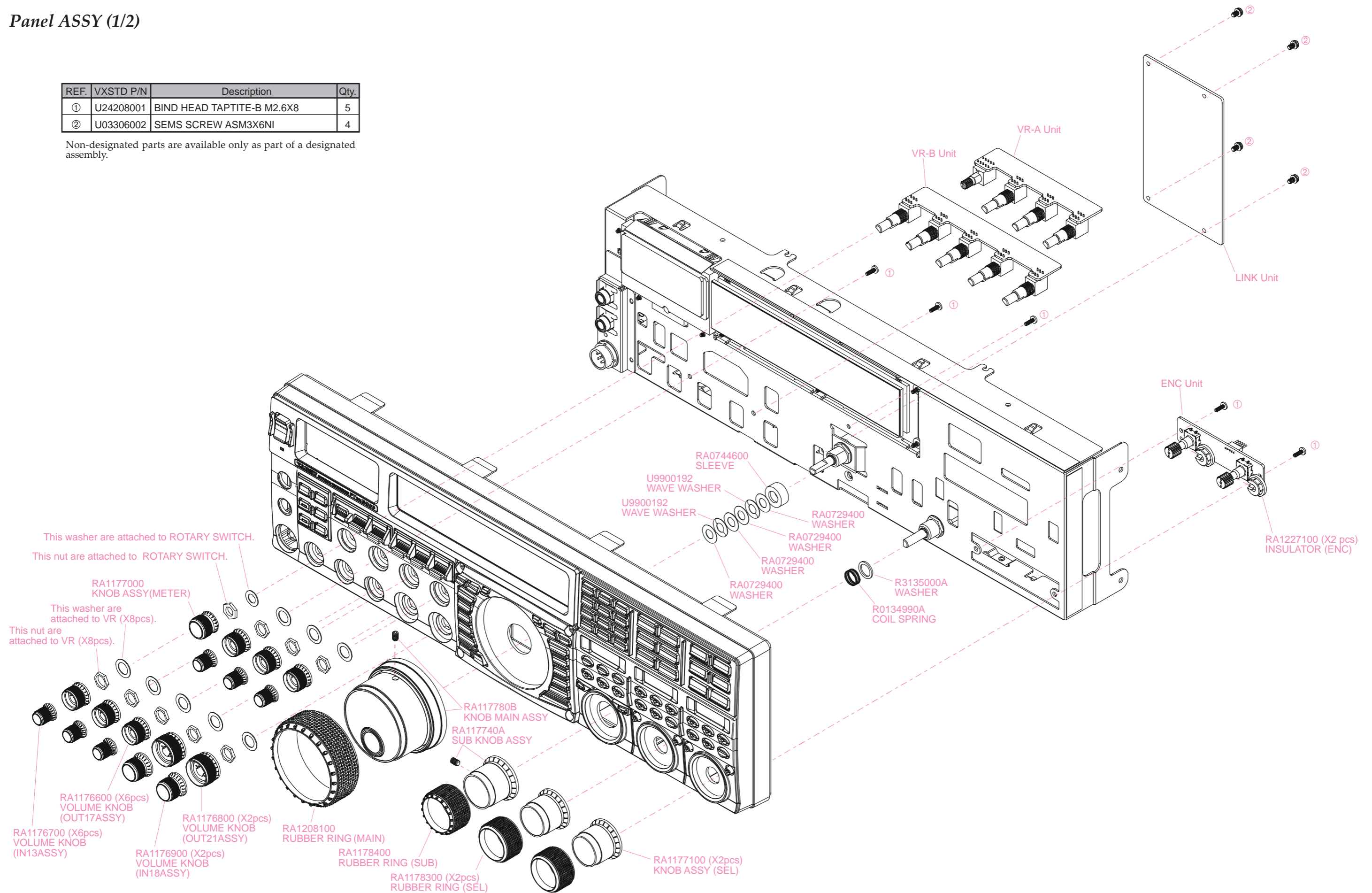

REF.	VXSTD P/N	Description	Qty.
①	U24105001	BIND HEAD TAPTITE-B M2X5	55

Non-designated parts are available only as part of a designated assembly.

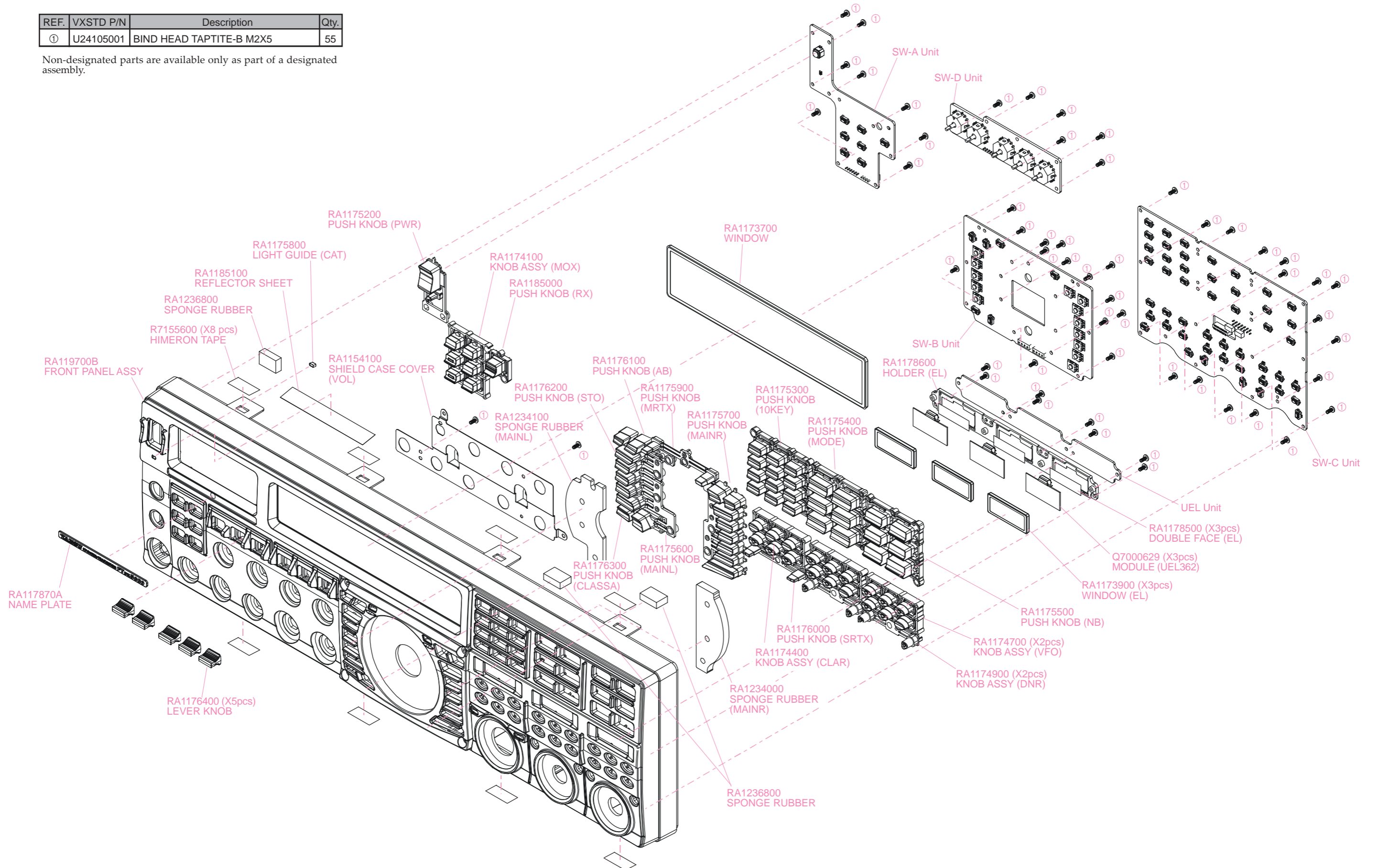

Exploded View

Panel Frame ASSY

REF.	VXSTD P/N	Description	Qty.
①	U24208001	BIND HEAD TAPTITE-B M2.6X8	9

Non-designated parts are available only as part of a designated assembly.

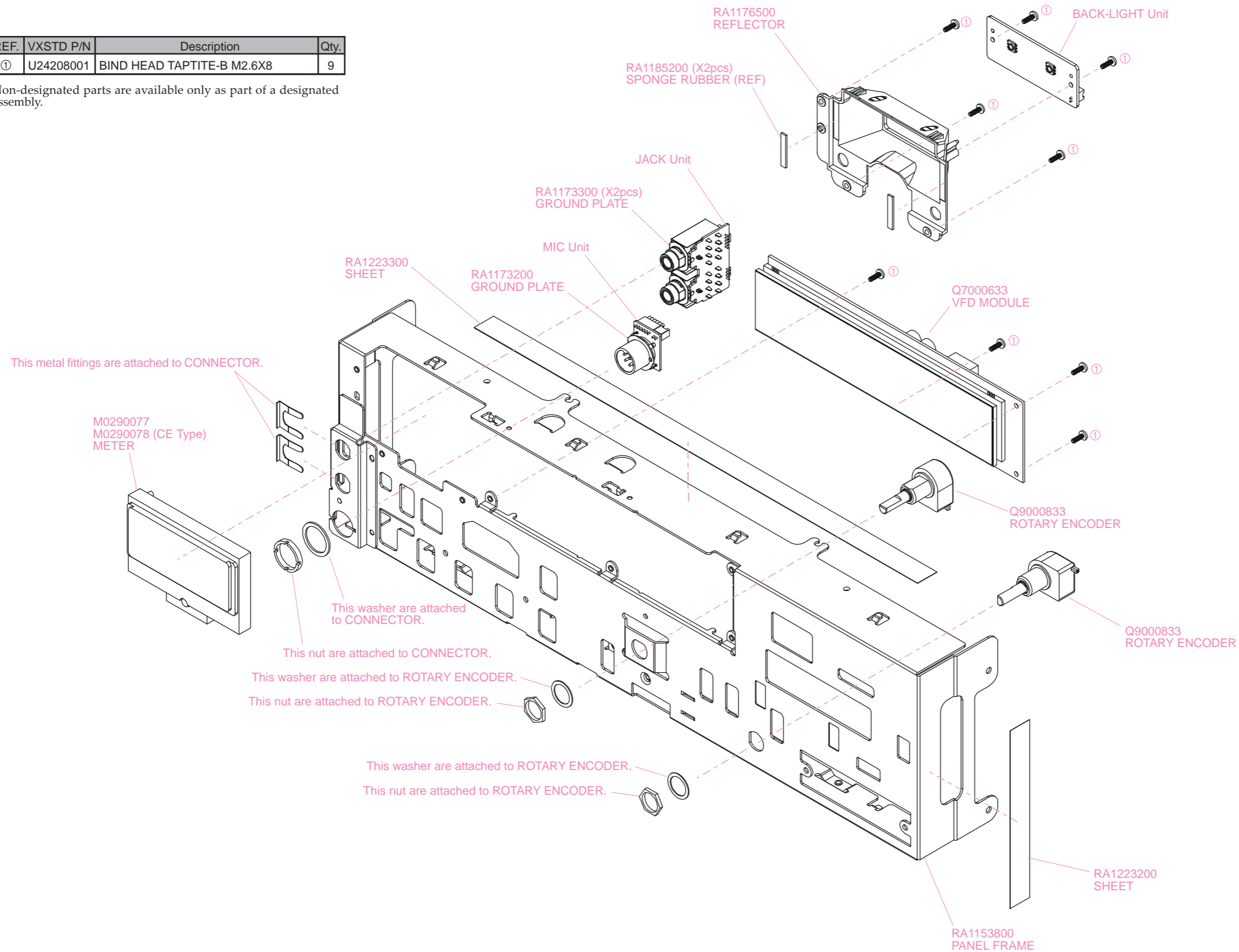

Exploded View

CHASSIS ASSY (1/4)

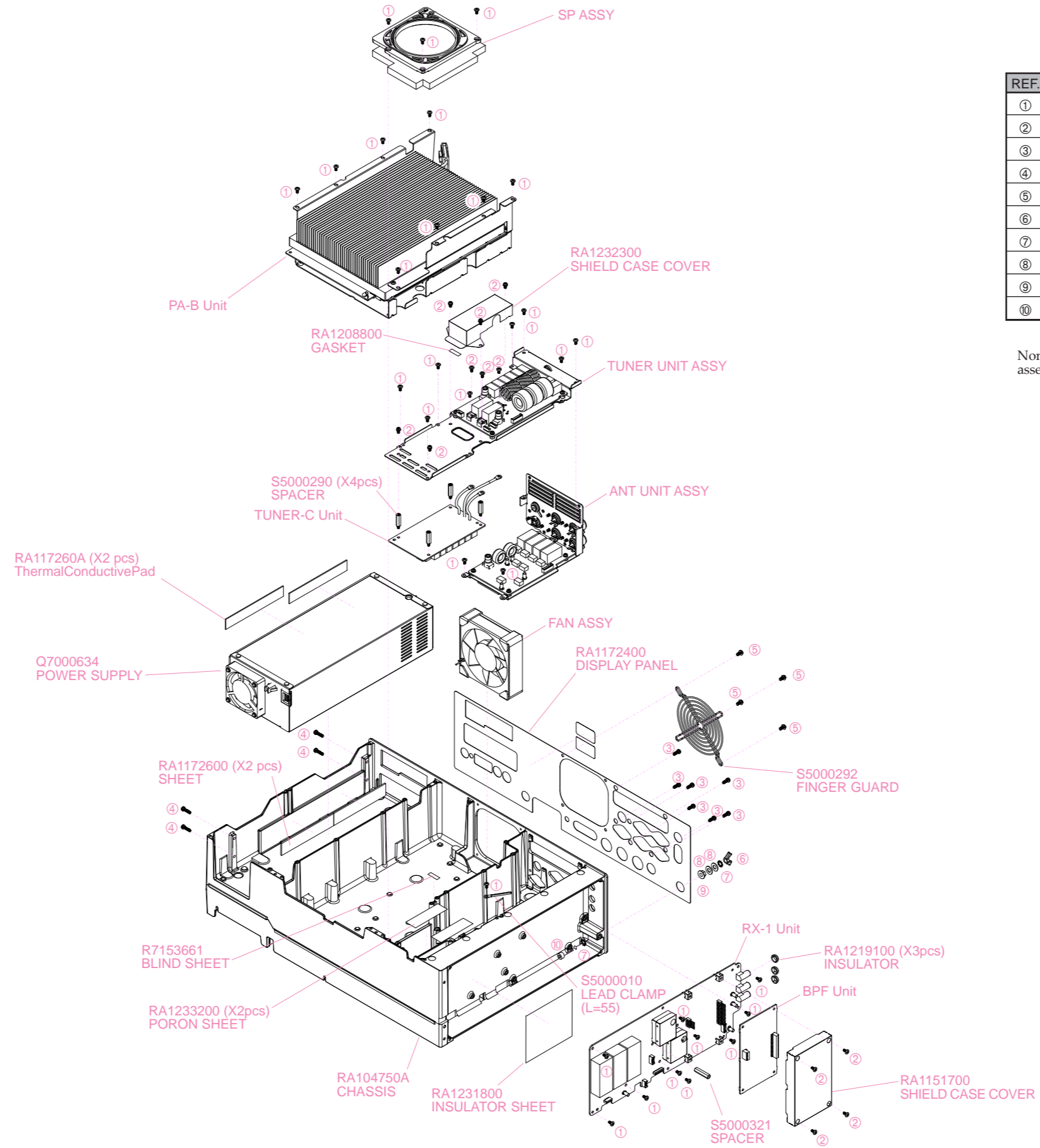

REF.	VXSTD P/N	Description	Qty.
①	U24306001	BIND HEAD TAPTITE-B M3X6	32
②	U03306002	SEMS SCREWASM3X6NI	12
③	U03310002	SEMS SCREWASM3X10NI	7
④	U03314001	SEMS SCREWASM3X14	4
⑤	U04308002	SEMS SCREWHSM3X8NI	4
⑥	U65500102	WING NUT N5NI	1
⑦	U72005002	TOOTHED LOCK WASHER OW5NI	2
⑧	U70005002	PLAIN WASHER FW5NI	2
⑨	U66500002	FLANGE NUT N5NI	1
⑩	U51525020	HEXA SOCKET BOLT M5X25SUS	1

Non-designated parts are available only as part of a designated assembly.

Exploded View

CHASSIS ASSY (2/4)

SP ASSY

REF.	VXSTD P/N	Description	Qty.
①	U9900021	PAN HEAD TAPTITE-B HM3X6	4

Non-designated parts are available only as part of a designated assembly.

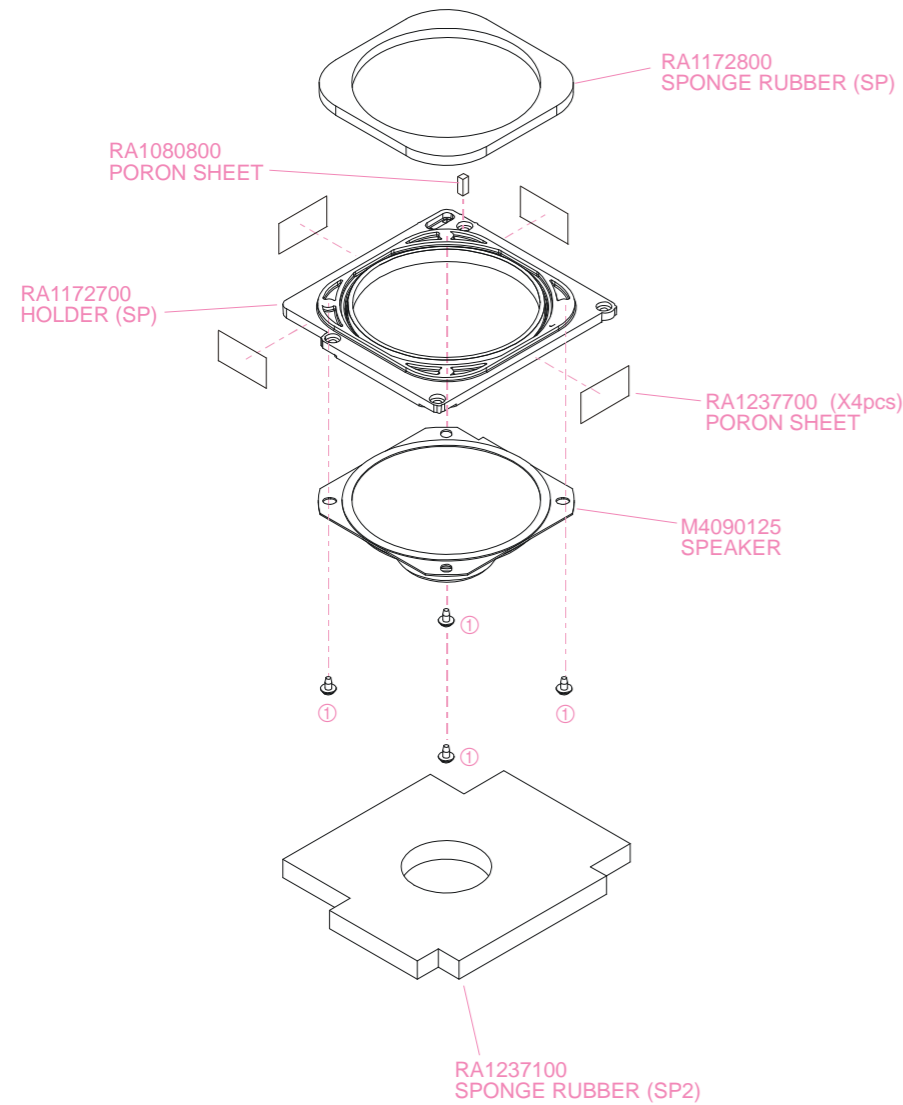

PA-B UNIT ASSY

REF.	VXSTD P/N	Description	Qty.
①	U24306001	BIND HEAD TAPTITE-B M3X6	6
②	U03306002	SEMS SCREW ASM3X6NI	15
③	U02312002	SEMS SCREW SM3X12NI	6
④	U34308001	FLAT HEAD TAPTITE-B M3X8	14
⑤	U03308002	SEMS SCREW ASM3X8NI	2
⑥	S5000223	SPACER	12
⑦	S5000321	SPACER	1

Non-designated parts are available only as part of a designated assembly.

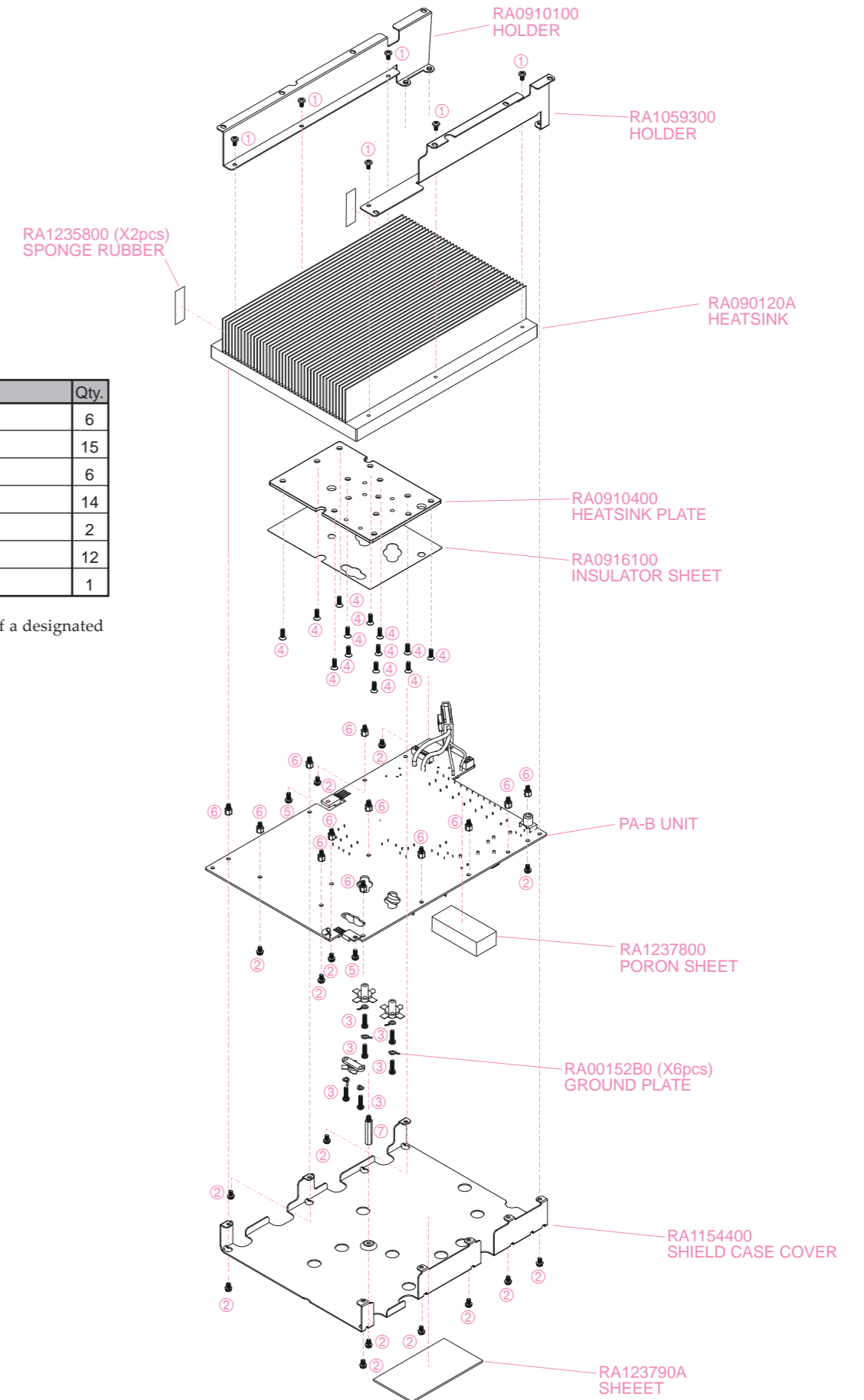

FAN ASSY

Non-designated parts are available only as part of a designated assembly.

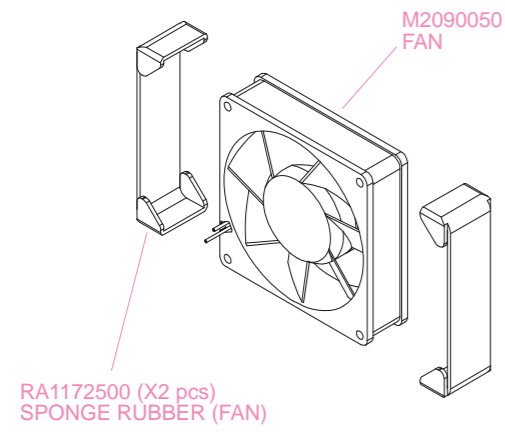

TUNER UNIT ASSY

REF.	VXSTD P/N	Description	Qty.
①	U03306002	SEMS SCREWASM3X6NI	4

Non-designated parts are available only as part of a designated assembly.

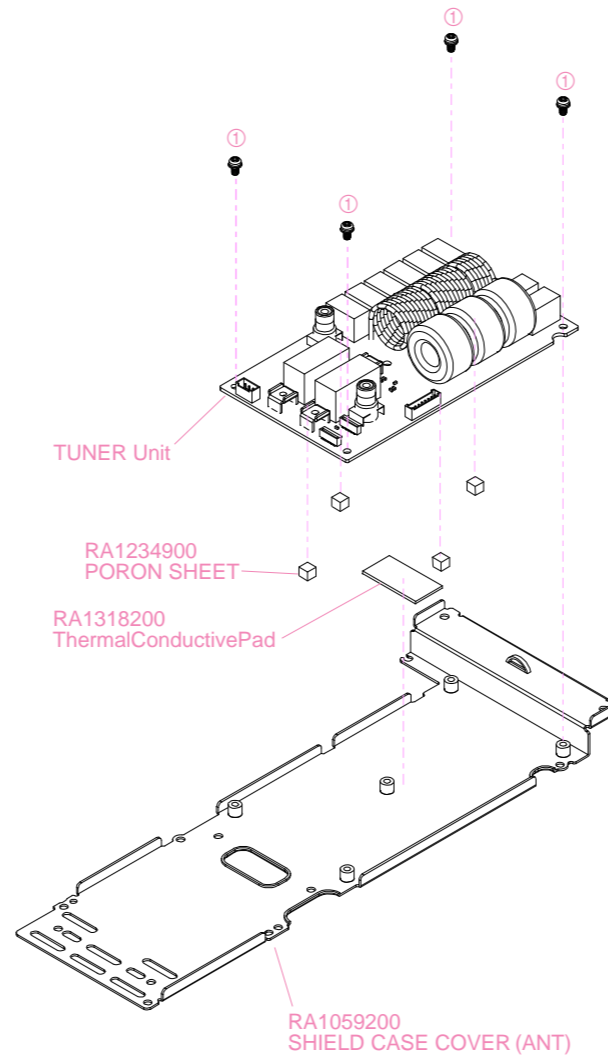

ANT UNIT ASSY

REF.	VXSTD P/N	Description	Qty.
①	U03306002	SEMS SCREWASM3X6NI	4
②	U44308002	PAN HEAD TAPTITE-B M3X8NI	10

Non-designated parts are available only as part of a designated assembly.

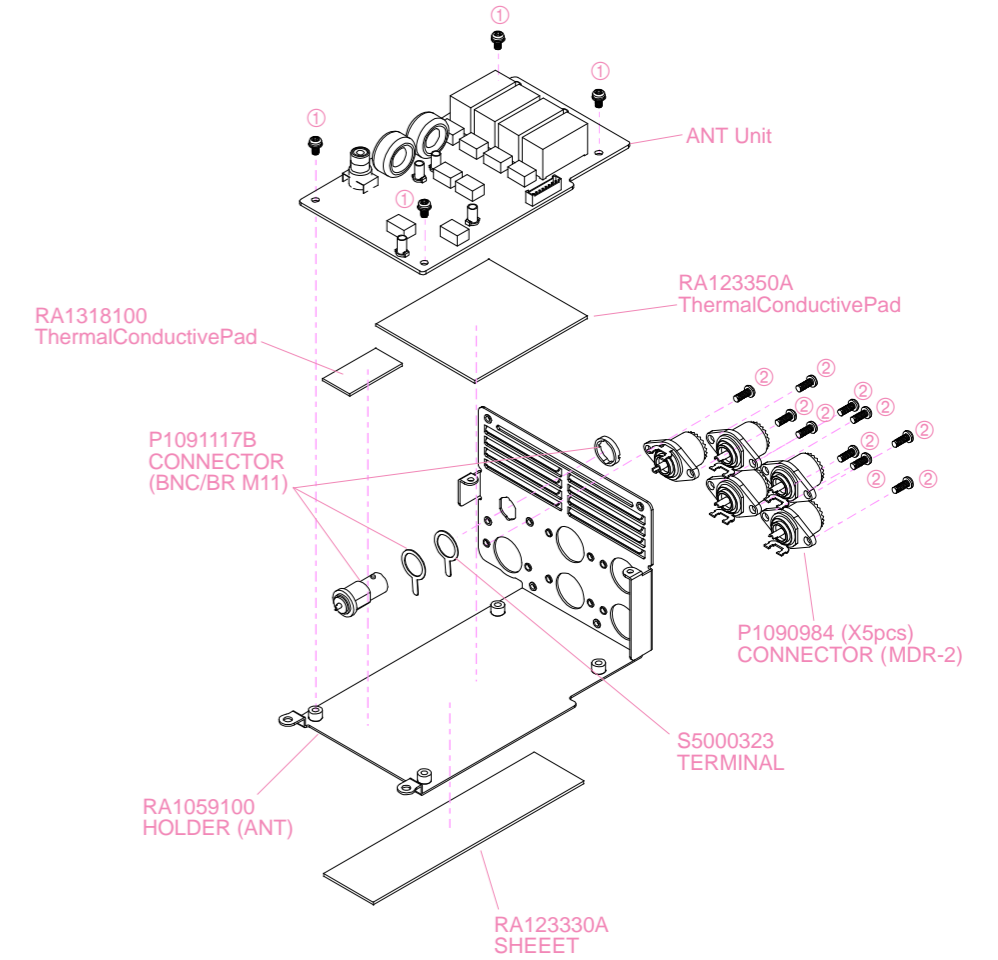

Exploded View

CHASSIS ASSY (4/4)

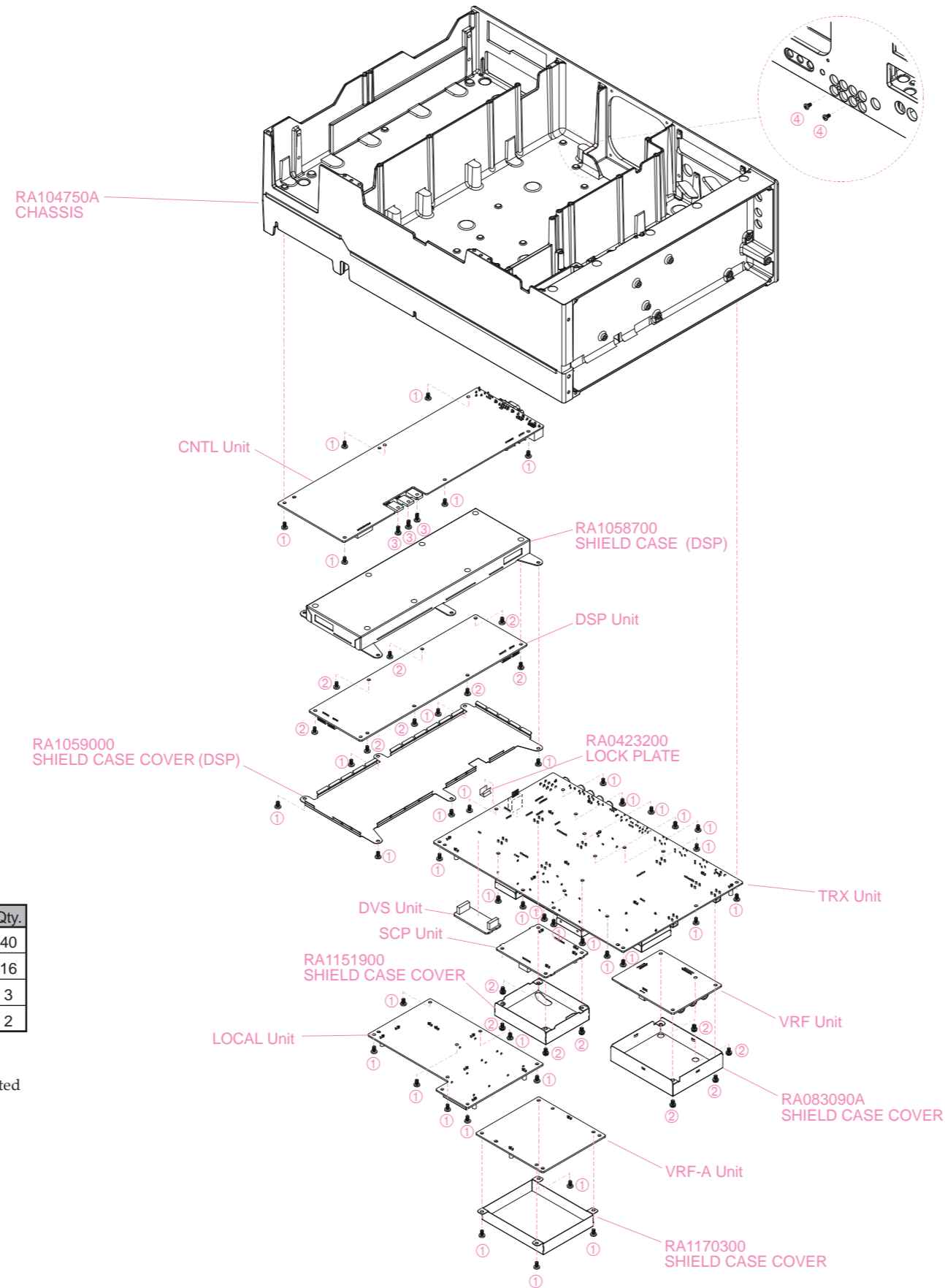

REF.	VXSTD P/N	Description	Qty.
①	U24306001	BIND HEAD TAPTITE-B M3X6	40
②	U03306002	SEMS SCREW ASM3X6NI	16
③	U24308001	BIND HEAD TAPTITE-B M3X8	3
④	U44308002	PAN HEAD TAPTITE-B M3X8NI	2

Non-designated parts are available only as part of a designated assembly.

BLOCK-DIAGRAM BP025100*

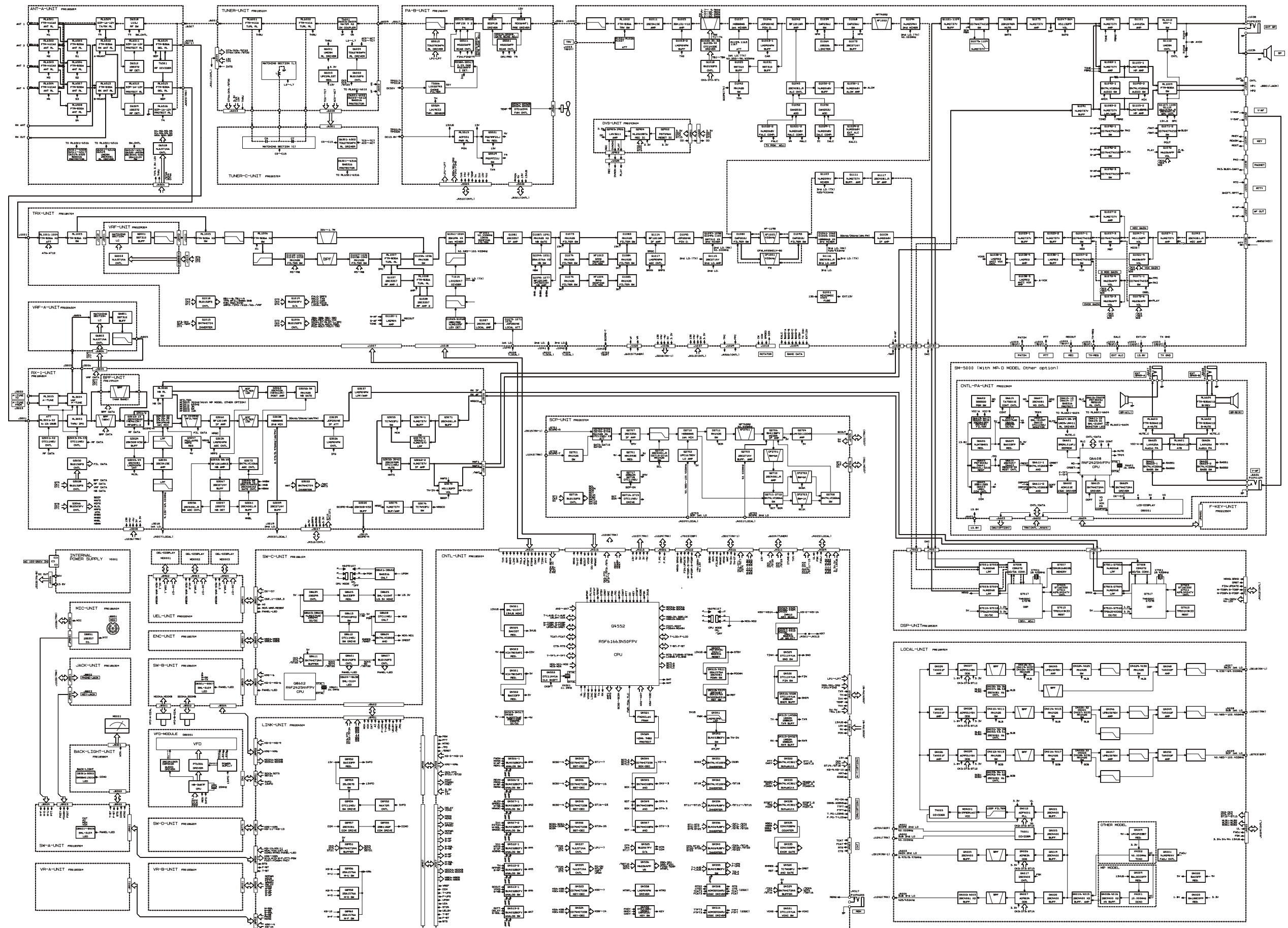

BLOCK DIAGRAM (Lot. 2~)

BLOCK-DIAGRAM BP025100*

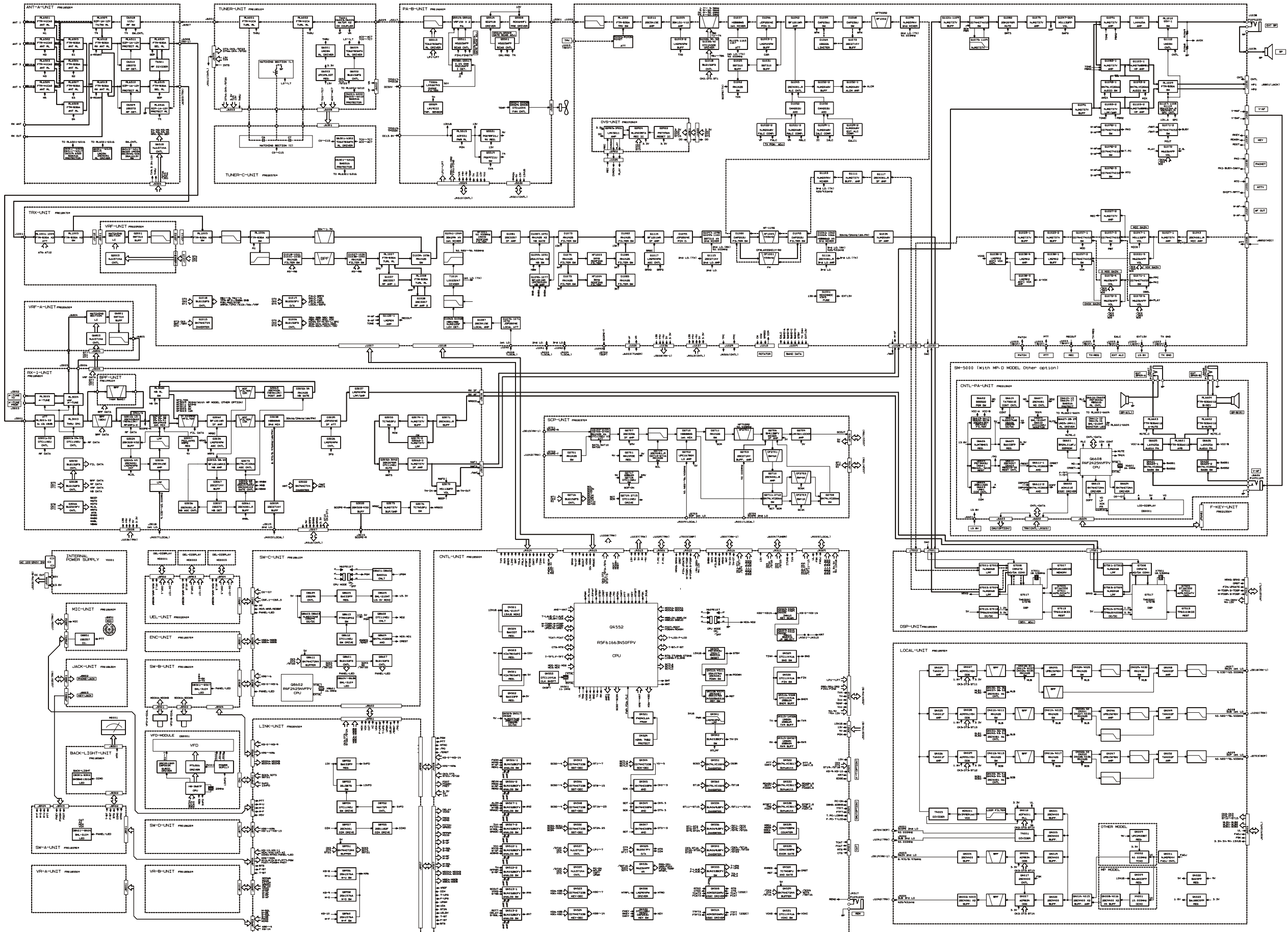

CONNECTION-DIAGRAM
BP0250900

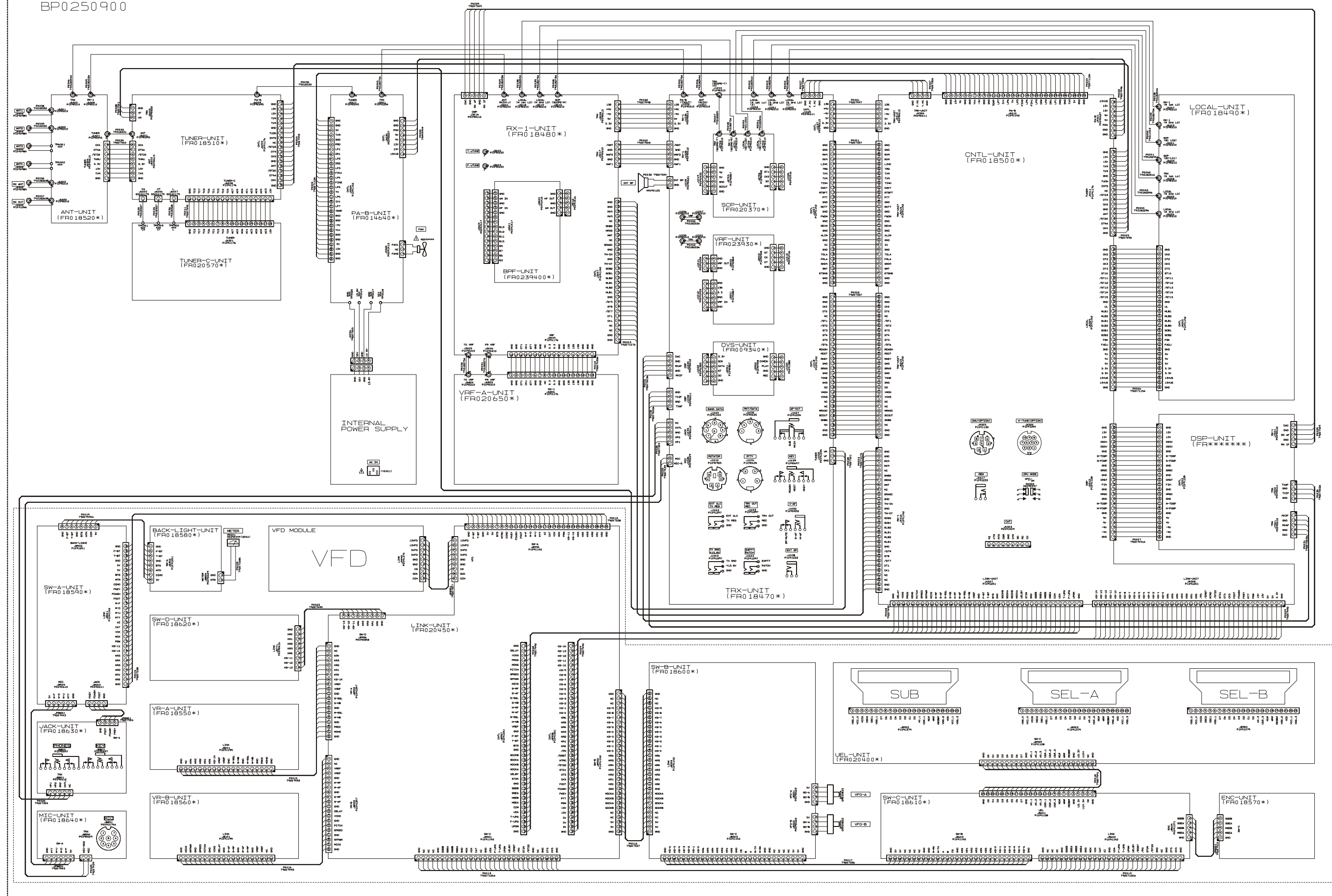

CONNECTION DIAGRAM (Lot. 2~)

CONNECTION-DIAGRAM
BP0250900*

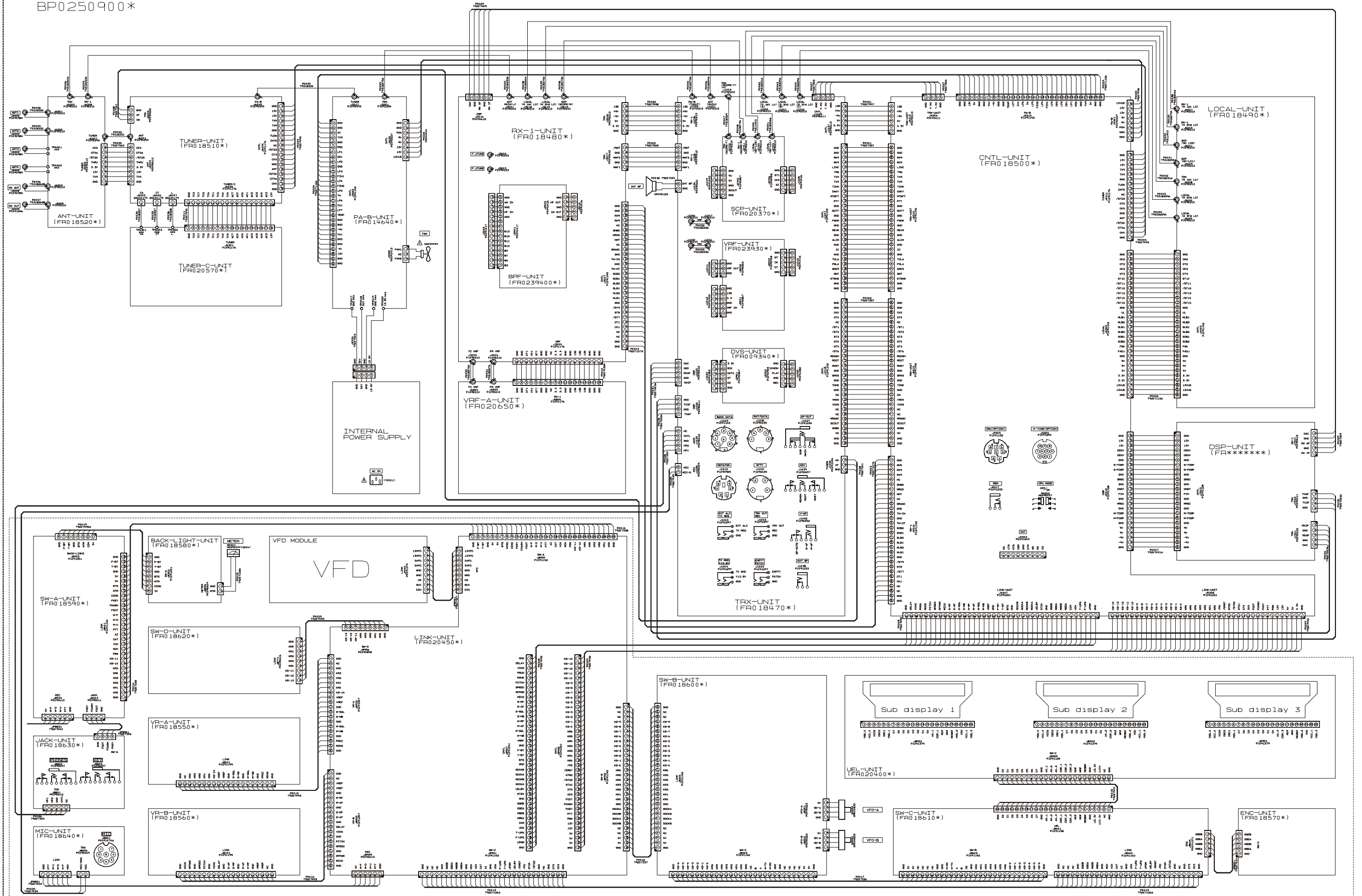

Introduction and Precautions

The following procedures cover adjustments that are not normally required once the transceiver has left the factory. However, If a problem occurs during normal operation due to component failure; realignment may be required after the faulty components have been replaced.

We recommend that authorized Vertex Standard Technicians, who are experienced with the circuitry and fully equipped to repair and align our products, perform repairs. If a fault is suspected, contact the selling dealer for instructions regarding repair. Authorized Vertex Standard Technicians have the latest information to align all circuits and make complete performance checks to ensure compliance with factory specifications after repairs.

Those who do undertake any of the following alignments are cautioned and proceed at their own risk. Problems caused by unauthorized attempts at realignment are not covered by the warranty policy.

Vertex Standard must reserve the right to change circuits and alignment procedures in the interest of improved performance, without notifying owners.

Under no circumstances should any alignment be attempted unless the normal functions and operation of the transceiver are clearly understood, the cause of the malfunction has been clearly identified and all faulty components replaced. The need for realignment should be determined to be absolutely necessary.

The following test equipment (and a thorough familiarity with its correct use) is necessary for correct realignment. Most steps do not require all of the equipment listed. The interactions of some adjustments may require that more complex adjustments be performed in a sequence. Do not attempt to perform only a single step unless it is clearly isolated electrically from all other steps. Have all test equipment ready before beginning, and follow all of the steps in a section in the order they are presented.

Required Test Equipment

- RF Signal Generator
- AF Signal Generator
- Spectrum Analyzer good to at least 1 GHz.
- Frequency Counter
- SINAD Meter
- RF Millivoltmeter
- Digital DC Voltmeter (high-Z, 1 M-Ohm/V)
- DC Voltmeter
- DC Ammeter (30 A)
- Ohmmeter
- DMU-2000 Data Management Unit
- 50-Ohm Dummy Load (200 watts)
- 100-Ohm Dummy Load (200 watts)
- 150-Ohm Dummy Load (200 watts)
- In-Line Wattmeter (200 watts, 50-Ohm)
- Linear Detector
- RF Coupler
- 4-Ohm AF Dummy Load (3 watts)

Alignment Preparation & Precautions

A 50-ohm RF Dummy load and in-line wattmeter must be connected to the "ANT 1" jack in all procedures that call for transmission, except where specified otherwise. Correct alignment is not possible with an antenna.

After completing one step, read the following step to determine whether the same test equipment will be required. If not, remove the unneeded test equipment before proceeding. (except the dummy load and wattmeter).

Correct alignment requires that the ambient temperature be maintained constant between 68 °F ~ 86 °F (20 °C ~ 30 °C). When the transceiver is brought into the shop from a hot or cold environment, it should be allowed time to come to room temperature before alignment. Also, the test equipment must be thoroughly warmed up before beginning.

Whenever possible, alignments should be made with oscillator shields and circuit boards firmly affixed in place. Also, the test equipment must be thoroughly warmed up before beginning.

Note: Signal levels in dB referred to in this procedure are based on 0 dB μ = 0.5 μ V (closed circuit).

Alignment

Analog Meter Adjustment

Meter Full Adjustment

- ❑ Press and hold in the [1(1.8)], [2(3.5)], and [3(7)] keys, while turning the radio on, to enter the alignment mode.
- ❑ Rotate the (VFO-A)[SELECT] Knob to select the alignment parameter “01-01 MTR FULL.”
- ❑ Rotate the (VFO-B)[SELECT] knob so that the Main S-meter deflects to full scale.
- ❑ Press and hold in the [MENU] button for 2 seconds to save the new setting and exit from the alignment mode.

[1(1.8)], [2(3.5)], and [3(7)] keys

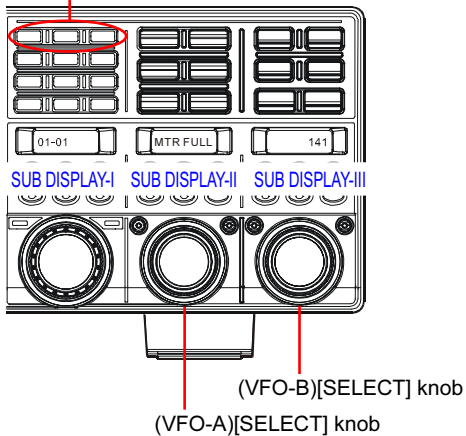

VDD Meter Adjustment

- ❑ Connect the DC voltmeter to TP5518 on the PA-B Unit.
- ❑ Switch the external display to “SWR Monitor” page.
- ❑ Press and hold in the [1(1.8)], [2(3.5)], and [3(7)] keys, while turning the radio on, to enter the alignment mode.
- ❑ Rotate the (VFO-A)[SELECT] knob to select the alignment parameter “01-02 VDD MTR.”
- ❑ Press the [ENT] key, then rotate the (VFO-B)[SELECT] knob so that the VDD meter reading is the same as that on the DC voltmeter.
- ❑ Rotate the (VFO-A)[SELECT] knob to select the alignment parameter “01-03 VDD TFT.”
- ❑ Rotate the (VFO-B)[SELECT] knob so that the VDD meter (on the external display) reading is the same as that on the DC voltmeter.
- ❑ Press and hold in the [MENU] button for 2 seconds to save the new setting and exit from the alignment mode.

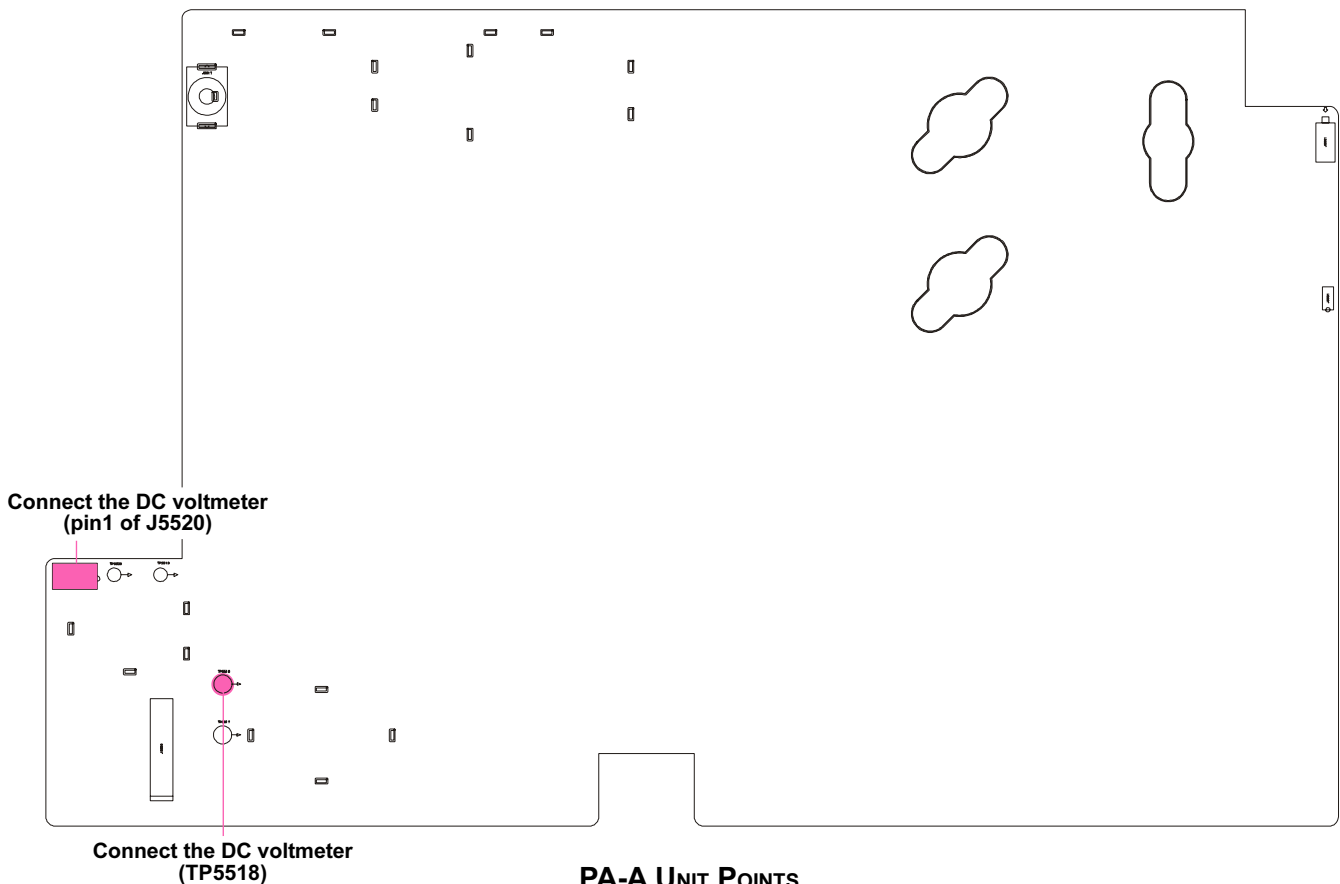

PA-A UNIT POINTS

TEMP Meter Adjustment

- ❑ Connect the DMU-2000 to the FTDX5000, and set the external display screen to the SWR page to view the temperature indication.
- ❑ Press and hold in the [1(1.8)], [2(3.5)], and [3(7)] keys, while turning the radio on, to enter the alignment mode.
- ❑ Rotate the (VFO-A)[SELECT] knob to select the alignment parameter "01-04 TEMP."
- ❑ Rotate the (VFO-B)[SELECT] knob so that the SUB DISPLAY-III is reads "70."
- ❑ Confirm that the temperature-meter reads $80\text{ }^{\circ}\text{C} \pm 5\text{ }^{\circ}\text{C}$.
- ❑ Rotate the (VFO-B)[SELECT] knob so that the SUB DISPLAY-III is reads "125."
- ❑ Confirm that the temperature-meter reads $20\text{ }^{\circ}\text{C} \pm 5\text{ }^{\circ}\text{C}$.
- ❑ Press and hold in the [MENU] button for 2 seconds to save the new setting and exit from the alignment mode.

[1(1.8)], [2(3.5)], and [3(7)] keys

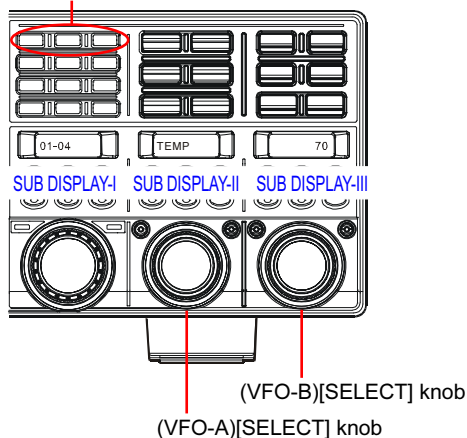

Cooling fan Adjustment

- ❑ Connect the DC voltmeter to pin 1 of J5520 on the PA-B Unit.
- ❑ Press and hold in the [1(1.8)], [2(3.5)], and [3(7)] keys, while turning the radio on, to enter the alignment mode.
- ❑ Rotate the (VFO-A)[SELECT] knob to select the alignment parameter "01-05 FAN."
- ❑ Rotate the (VFO-B)[SELECT] knob so that the SUB display-III reads "110" or less.
- ❑ Confirm the fan is stopped.
- ❑ Rotate the (VFO-B)[SELECT] knob so that the SUB display-III display is reads "127."
- ❑ Confirm that the voltmeter reads $7.2\text{ V} \pm 0.3\text{ V}$.
- ❑ Rotate the (VFO-B)[SELECT] knob so that the SUB display-III display is reads "146."
- ❑ Confirm that the voltmeter reads $6.3\text{ V} \pm 0.3\text{ V}$.
- ❑ Rotate the (VFO-B)[SELECT] knob so that the SUB display-III display is reads "165."
- ❑ Confirm that the voltmeter reads $4.3\text{ V} \pm 0.3\text{ V}$.
- ❑ Rotate the (VFO-B)[SELECT] knob so that the SUB display-III display is reads "187."
- ❑ Confirm that the voltmeter reads less than 0.5 V.
- ❑ Press and hold in the [MENU] button for 2 seconds to save the new setting and exit from the alignment mode.

Alignment

Local Adjustment

2nd Local Oscillator Adjustment

- Disconnect the coaxial cable from J4002 on the LOCAL Unit, then connect the Frequency counter to J4002.
- Press and hold in the [1(1.8)], [2(3.5)], and [3(7)] keys, while turning the radio on, to enter the alignment mode.
- Rotate the (VFO-A)[SELECT] knob to select the alignment parameter "01-06 FREQ."
- Rotate the (VFO-B)[SELECT] knob so that the Frequency counter reading is "40.000 MHz (± 2 Hz)."
- Press and hold in the [MENU] button for 2 seconds to save the new setting and exit from the alignment mode.

OCXO Only

- Disconnect the Frequency counter from J4002, then connect the RF millivoltmeter to J4002.
- Connect the RF millivoltmeter to TP4010.
- Adjust T4003, T4004 and T4006 on the LOCAL Unit for maximum deflection on the RF millivoltmeter (more than -10 dBm).
- Disconnect the RF millivoltmeter from TP4010.

PLL (Main) Adjustment

- Connect the Digital DC voltmeter (high-Z) to TP4004 on the LOCAL Unit.
- Confirm that the voltmeter reads $3.0\text{ V} \pm 1.5\text{ V}$.

2nd Local (Sub, SCP) Adjustment

- Disconnect the coaxial cable from J4001 on the LOCAL Unit, then connect the RF millivoltmeter to J4001.
- Confirm that the RF millivoltmeter reads $-3\text{ dBm} \pm 3\text{ dBm}$.
- Disconnect the RF millivoltmeter from J4001, then re-connect the coaxial cable to J4001.
- Disconnect the coaxial cable from J4002 on the LOCAL Unit, then connect the RF millivoltmeter to J4002.
- Confirm that the RF millivoltmeter reads $-3\text{ dBm} \pm 3\text{ dBm}$.
- Disconnect the RF millivoltmeter from J4002, then re-connect the coaxial cable to J4002.

Main 2nd Local Adjustment

- Connect the RF millivoltmeter to TP4003.
- Adjust T4002 on the LOCAL Unit for maximum deflection on the RF millivoltmeter (more than 0.42 dBm).
- Disconnect the RF millivoltmeter from TP4003.

Sub 3rd Local Adjustment

- Connect the RF millivoltmeter to TP4001.
- Confirm that the RF millivoltmeter reads $-0.42\text{ Vrms} \pm 0.13\text{ Vrms}$.
- Disconnect the RF millivoltmeter from TP4001.

1st Local (Main, Sub, SCP) Adjustment

- Set the Main Band (VFO-A) frequency to 14.000 MHz in the SSB mode.
- Connect the RF millivoltmeter to TP4012.
- Confirm that the RF millivoltmeter reads $-0.28\text{ Vrms} \pm 0.08\text{ Vrms}$.
- Disconnect the RF millivoltmeter from TP4012.
- Connect the RF millivoltmeter to TP4013.
- Confirm that the RF millivoltmeter reads $-0.28\text{ Vrms} \pm 0.08\text{ Vrms}$.
- Disconnect the RF millivoltmeter from TP4013.
- Connect the RF millivoltmeter to TP4014.
- Confirm that the RF millivoltmeter reads $-0.28\text{ Vrms} \pm 0.08\text{ Vrms}$.
- Disconnect the RF millivoltmeter from TP4014.

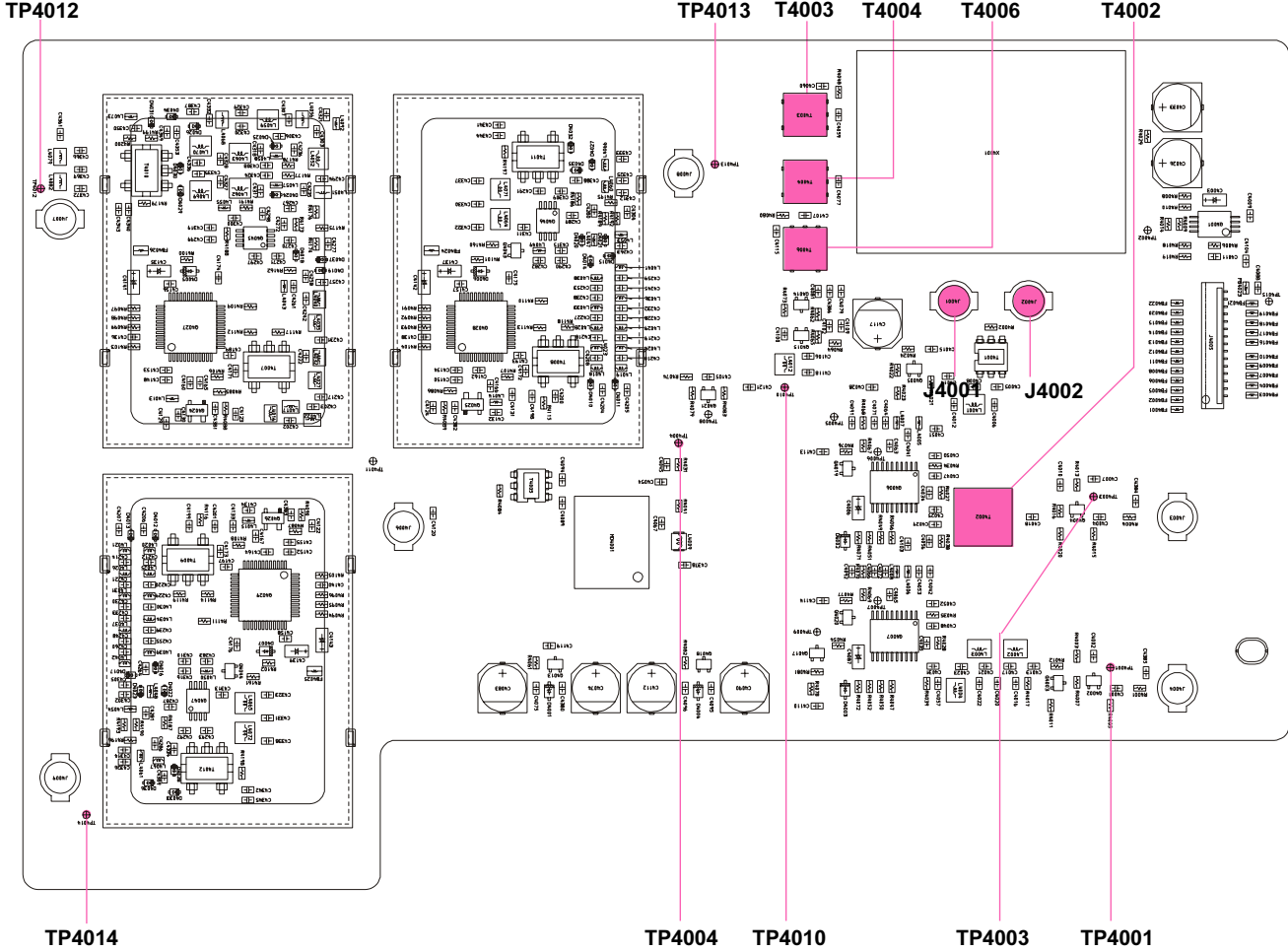

LOCAL UNIT ALIGNMENT POINTS

Alignment

Main Receiver Adjustment

1st Local Oscillator Adjustment

- Set the following controls as indicated:
 - [IPO] button: AMP1
 - [ATT] button: OFF
 - [FLT] button: THRU
 - [R.FLT] button: AUTO
 - [AGC] button: AUTO
 - [RF GAIN] knob: Fully clockwise
 - [MODE] button: CW
- Connect the RF millivoltmeter to TP3038 on the RX-1 Unit.
- Press and hold in the [1(1.8)], [2(3.5)], and [3(7)] keys, while turning the radio on, to enter the alignment mode.
- Select the appropriate “Alignment Parameter” using the (VFO-A)[SELECT] knob per the chart below, and adjust the (VFO-B)[SELECT] knob for the corresponding RF millivoltmeter reading at each frequency.

ALIGNMENT PARAMETER	VFO-A FREQUENCY	RF MILLIVOLTMETER
02-01 M-L1.8	1.850 MHz	1.10 Vrms (± 0.05 Vrms)
02-02 M-L3.5	3.750 MHz	1.10 Vrms (± 0.05 Vrms)
02-03 M-L7	7.100 MHz	1.10 Vrms (± 0.05 Vrms)
02-04 M-L14	14.200 MHz	1.10 Vrms (± 0.05 Vrms)
02-05 M-L21	21.200 MHz	1.0 Vrms (± 0.05 Vrms)
02-06 M-L28	28.700 MHz	1.0 Vrms (± 0.05 Vrms)
02-07 M-L50	50.100 MHz	0.6 Vrms (+0.05 Vrms/-0.1 Vrms)

- Press and hold in the [MENU] button for 2 seconds to save the new setting and exit from the alignment mode.

2nd/3rd Local Level Adjustment

- Set the following controls as indicated:
 - [IPO] button: AMP1
 - [ATT] button: OFF
 - [FLT] button: THRU
 - [R.FLT] button: AUTO
 - [AGC] button: AUTO
 - [RF GAIN] knob: Fully clockwise
- Connect the RF millivoltmeter to TP3023 on the RX-1 Unit.
- Adjust T3020 on the RX-1 Unit for maximum deflection on the RF millivoltmeter (more than +0.5 dBm).

IF Transformer Adjustment

- Set the following controls as indicated:
 - [IPO] button: AMP1
 - [ATT] button: OFF
 - [FLT] button: THRU
 - [AGC] button: AUTO
 - [RF GAIN] knob: Fully clockwise
 - [MODE] button: CW
- Set the Main Band (VFO-A) frequency to 14.200 MHz in the CW mode.
- Connect the AF millivoltmeter and 4 Ohm dummy load to the EXT SP jack.
- Connect the RF Signal Generator to the “ANT 1” jack, then set the output level to 0 dB μ at the 14.200 MHz.
- Set the Roofing filter bandwidth to “3 kHz” by pressing the [R.FLT] Switch.
- Adjust T3025, T3021 and T3018 on the RX-1 Unit in succession several times for maximum deflection on the AF millivoltmeter.

If the Main S-meter deflects while adjusting, reduce the RF Signal Generator output so that the Main S-meter does not deflect.

- Set the Roofing filter bandwidth to “6 kHz” by pressing the [R.FLT] Switch.
- Adjust T3032 and T3027 on the RX-1 Unit in succession several times for maximum deflection on the AF millivoltmeter.

If the Main S-meter deflects while adjusting, reduce the RF Signal Generator output so that the Main S-meter does not deflect.
- Set the Roofing filter bandwidth to “15 kHz” by pressing the [R.FLT] Switch.
- Adjust T3031 and T3026 on the RX-1 Unit in succession several times for maximum deflection on the AF millivoltmeter.

If the Main S-meter deflects while adjusting, reduce the RF Signal Generator output so that the Main S-meter does not deflect.

MCF Adjustment

- ❑ Set the following controls as indicated:
 [IPO] button: AMP2
 [ATT] button: OFF
 [FLT] button: THRU
 [R.FLT] button: AUTO
 [AGC] button: AUTO
 [RF GAIN] knob: Fully clockwise
- ❑ Set the Main Band (VFO-A) frequency to 28.000 MHz in the FM-W mode.
- ❑ Connect the AC millivoltmeter, SINAD meter, and 4 Ohm dummy load to the EXT SP jack.
- ❑ Connect the RF Signal Generator to the "ANT 1" jack, then set the output level to 0 dB μ at 28.000 MHz.
- ❑ Set the Roofing filter bandwidth to "15 kHz" by pressing the [R.FLT] button.

- ❑ Adjust T3031, T3026, T3021 and T3018 on the RX-1 Unit in succession several times for maximum deflection on the SINAD meter.
 If the Main S-meter deflects while adjusting, reduce the RF Signal Generator output so that the Main S-meter does not deflect.
- ❑ Set the Main Band (VFO-A) frequency to 28.000 MHz in the AM mode, and set the IPO to "AMP2" by pressing the [IPO] button.
- ❑ Set the Roofing filter bandwidth to "6 kHz" by pressing the [R.FLT] button, and set the IPO to "AMP2" by pressing the [IPO] button.
- ❑ Set the RF Signal Generator output to +36 dB μ (AM: 1kHz, 30%) at 28.000 MHz.
- ❑ Adjust T3032 and T3027 on the RX-1 Unit in succession several times for maximum deflection on the AF millivoltmeter.
 If the Main S-meter deflects while adjusting, reduce the RF Signal Generator output so that the Main S-meter does not deflect.

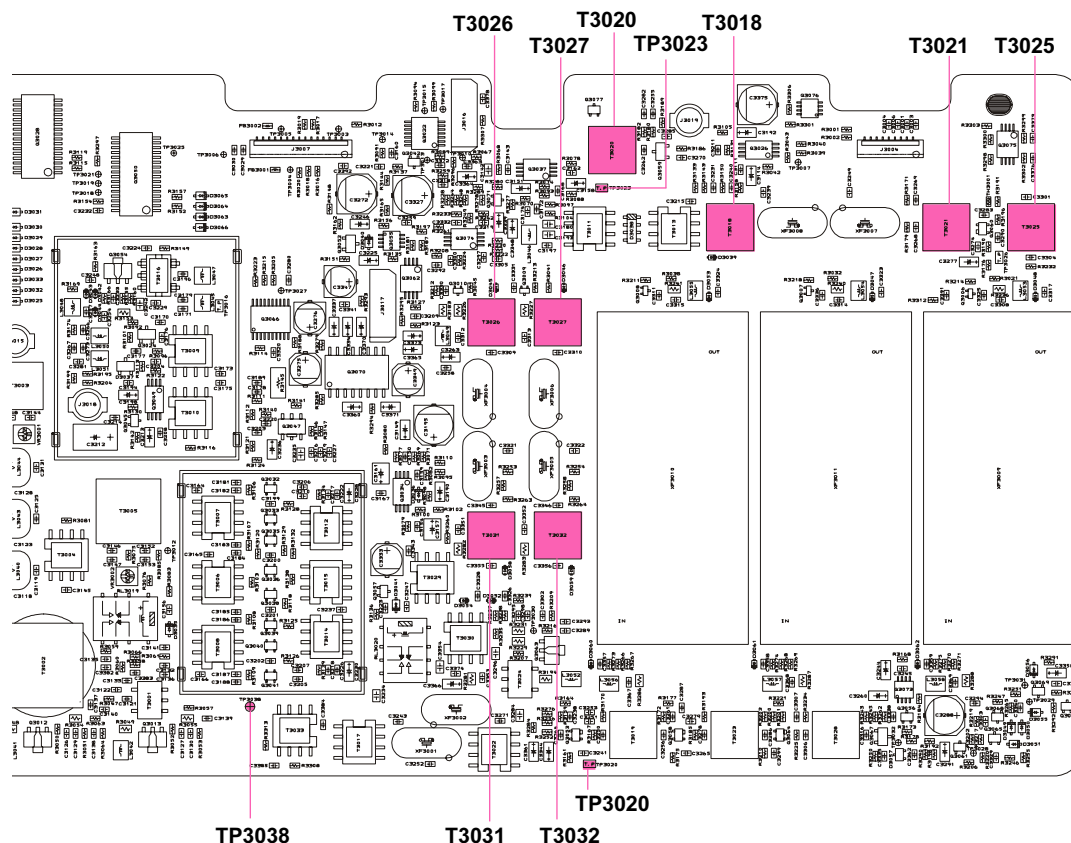

RX-1 UNIT (RECEIVER SECTION) ALIGNMENT POINTS

Alignment

Noise Blanker Circuit Adjustment

- Set the following controls as indicated:
 - [IPO] button: AMP1
 - [ATT] button: OFF
 - [R.FLT] button: AUTO
 - [AGC] button: AUTO
 - [NB] button: ON (for short-duration pulse noise)
 - [NB] knob: 12 o' clock
 - [RF GAIN] knob: Fully clockwise
 - [VRF] button: THRU
- Set the Main Band (VFO-A) frequency to 14.200 MHz in the CW mode.
- Connect the DC voltmeter to TP3020 on the MAIN Unit.
- Connect the RF Signal Generator to the "ANT 1" jack, then set the output level to 20 dB μ at 14.200 MHz.
- Adjust T1019, T3023 and T3028 on the RX-1 Unit for minimum deflection on the DC voltmeter.
- Turn the NB to "OFF" by pressing the [NB] button.
- Disconnect the RF millivoltmeter from TP3020.

IF Trap (9MHz) Adjustment

- Set the following controls as indicated:
 - [IPO] button: AMP2
 - [ATT] button: OFF
 - [R.FLT] button: AUTO
 - [AGC] button: AUTO
 - [RF GAIN] knob: Fully clockwise
 - [VRF] button: THRU
- Set the Main Band (VFO-A) frequency to 10.000 MHz in the CW mode.
- Connect the AC millivoltmeter and 4 Ohm dummy load to the EXT SP jack.
- Connect the RF Signal Generator to the "ANT 1" jack, then set the output level to 60 dB μ ~ 90 dB μ at 9.000 MHz.
- Adjust T3005 on the MAIN Unit for minimum deflection on the AC millivoltmeter.
If the Main S-meter deflects while adjusting, reduce the RF Signal Generator output so that the Main S-meter does not deflect.

IF OUT Adjustment

- Set the following controls as indicated:
 - Menu item: 109 RGEN IF OUT (ENABLE)
 - [IPO] button: AMP2
 - [ATT] button: OFF
 - [R.FLT] button: AUTO
 - [AGC] button: AUTO
 - [RF GAIN] knob: Fully clockwise
 - [VRF] button: THRU
- Connect the RF millivoltmeter to TP3037 on the RX-1 Unit.
- Set the Main Band (VFO-A) frequency to 14.200 MHz in the CW mode.
- Then set the output level to 80 dB μ ~ 100 dB μ at 14.200 MHz.
- Adjust T3034 on the MAIN Unit for minimum deflection on the RF millivoltmeter.
- Disconnect the RF millivoltmeter from TP3037.

IF Trap (Scope) Adjustment

- Set the following controls as indicated:
 - [IPO] button: AMP2
 - [ATT] button: OFF
 - [R.FLT] button: AUTO
 - [AGC] button: AUTO
 - [RF GAIN] knob: Fully clockwise
 - [VRF] button: THRU
- Set the Main Band (VFO-A) frequency to 40.455 MHz in the CW mode.
- Disconnect the coaxial cable from J3015 on the RX-1 Unit, then connect the RF millivoltmeter to J3015.
- Connect the RF Signal Generator to the "ANT 1" jack, then set the output level to 100 dB μ ~ 130 dB μ at 40.455 MHz.
- Adjust T3003 on the MAIN Unit for maximum deflection on the RF millivoltmeter.
- Disconnect the RF millivoltmeter from J3015, then re-connect the coaxial cable to J3015.

RF AGC Adjustment

- ❑ Set the following controls as indicated:
 - [ANT 1/2] button: ANT 1
 - [IPO] button: AMP1
 - [ATT] button: OFF
 - [R.FLT] button: AUTO
 - [AGC] button: AUTO
 - [RF GAIN] knob: Fully clockwise
 - [FLT] button: THRU
 - [MODE] button: CW
 - ❑ Connect the RF Signal Generator to the “ANT 1” jack, and connect the Digital DC voltmeter (high-Z) to J3016 pin 5 on the RX-1 Unit.
 - ❑ Press and hold in the [1(1.8)], [2(3.5)], and [3(7)] keys, while turning the radio on, to enter the alignment mode.
 - ❑ Select the appropriate “Alignment Parameter” using the (VFO-A)[SELECT] knob per the chart below, then set the RF Signal Generator output to each frequency & level, and adjust the (VFO-B)[SELECT] knob for the corresponding DC voltmeter reading at each frequency.
- | ALIGNMENT PARAMETER | RF SIGNAL GENERATOR | VFO-A FREQUENCY | DC VOLTMETER |
|---------------------|-------------------------|-----------------|-----------------------|
| 03-01 M-RGC1.8 | 1.900 MHz, 76 dB μ | 1.900 MHz | 0.2 V ($\pm 0.05V$) |
| 03-02 M-RGC3.5 | 3.750 MHz, 76 dB μ | 3.750 MHz | 0.2 V ($\pm 0.05V$) |
| 03-03 M-RGC7 | 7.150 MHz, 76 dB μ | 7.150 MHz | 0.2 V ($\pm 0.05V$) |
| 03-04 M-RGC10 | 10.125 MHz, 76 dB μ | 10.125 MHz | 0.2 V ($\pm 0.05V$) |
| 03-05 M-RGC14 | 14.175 MHz, 76 dB μ | 14.175 MHz | 0.2 V ($\pm 0.05V$) |
| 03-06 M-RGC18 | 18.117 MHz, 76 dB μ | 18.117 MHz | 0.2 V ($\pm 0.05V$) |
| 03-07 M-RGC21 | 21.255 MHz, 76 dB μ | 21.255 MHz | 0.2 V ($\pm 0.05V$) |
| 03-08 M-RGC24 | 24.940 MHz, 76 dB μ | 24.940 MHz | 0.2 V ($\pm 0.05V$) |
| 03-09 M-RGC28 | 28.850 MHz, 76 dB μ | 28.850 MHz | 0.2 V ($\pm 0.05V$) |
| 03-10 M-RGC50 | 52.000 MHz, 76 dB μ | 52.000 MHz | 0.2 V ($\pm 0.05V$) |
- ❑ Press and hold in the [MENU] button for 2 seconds to save the new setting and exit from the alignment mode.

IF Gain Adjustment

- ❑ Set the following controls as indicated:
 - [IPO] button: AMP1
 - [ATT] button: OFF
 - [R.FLT] button: 3 kHz
 - [AGC] button: AUTO
 - [PITCH] knob: 700 Hz
 - [RF GAIN] knob: Fully clockwise
 - [FLT] button: THRU
 - [MODE] button: CW
 - ❑ Connect the AC millivoltmeter and 4 Ohm dummy load to the EXT SP jack.
 - ❑ Connect the RF Signal Generator to the “ANT 1” jack, then set the output level to 36 dB μ at 1.900 MHz.
 - ❑ Set the Main Band (VFO-A) frequency to 1.900 MHz in the CW mode.
 - ❑ Press and hold in the [1(1.8)], [2(3.5)], and [3(7)] keys, while turning the radio on, to enter the alignment mode.
 - ❑ Adjust the Main [AF GAIN] knob so that the AC millivoltmeter reading is “0 dB.”
 - ❑ Select the appropriate “Alignment Parameter” using the (VFO-A)[SELECT] knob per the chart below, then set the RF Signal Generator output to each frequency & level, and adjust the (VFO-B)[SELECT] knob for the corresponding AC millivoltmeter reading at each frequency.
- | ALIGNMENT PARAMETER | RF SIGNAL GENERATOR | VFO-A FREQUENCY | AC MILLIVOLTMETER |
|---------------------|-------------------------|-----------------|-------------------------|
| 04-01 M-IGN1.8 | 1.900 MHz, 10 dB μ | 1.900 MHz | -1.5 dB (± 0.5 dB) |
| 04-02 M-IGN3.5 | 3.750 MHz, 10 dB μ | 3.750 MHz | -1.5 dB (± 0.5 dB) |
| 04-03 M-IGN7 | 7.150 MHz, 10 dB μ | 7.150 MHz | -1.5 dB (± 0.5 dB) |
| 04-04 M-IGN10 | 10.125 MHz, 10 dB μ | 10.125 MHz | -1.5 dB (± 0.5 dB) |
| 04-05 M-IGN14 | 14.175 MHz, 10 dB μ | 14.175 MHz | -1.5 dB (± 0.5 dB) |
| 04-06 M-IGN18 | 18.117 MHz, 10 dB μ | 18.117 MHz | -1.5 dB (± 0.5 dB) |
| 04-07 M-IGN21 | 21.255 MHz, 10 dB μ | 21.255 MHz | -1.5 dB (± 0.5 dB) |
| 04-08 M-IGN24 | 24.940 MHz, 10 dB μ | 24.940 MHz | -1.5 dB (± 0.5 dB) |
| 04-09 M-IGN28 | 28.850 MHz, 10 dB μ | 28.850 MHz | -1.5 dB (± 0.5 dB) |
| 04-10 M-IGN50 | 52.000 MHz, 10 dB μ | 52.000 MHz | -1.5 dB (± 0.5 dB) |
- ❑ Press and hold in the [MENU] button for 2 seconds to save the new setting and exit from the alignment mode.

Alignment

S-meter Adjustment

- ❑ Set the following controls as indicated:
 - [IPO] button: AMP1
 - [ATT] button: OFF
 - [R.FLT] button: 3 kHz
 - [AGC] button: AUTO
 - [RF GAIN] knob: Fully clockwise
 - [FLT] button: THRU
- ❑ Connect the RF Signal Generator to the “ANT 1” jack, then set the frequency to 14.200 MHz.
- ❑ Set the Main Band (VFO-A) frequency to 14.200 MHz in the CW mode.
- ❑ Press and hold in the [1(1.8)], [2(3.5)], and [3(7)] keys, while turning the radio on, to enter the alignment mode.
- ❑ Select the appropriate “Alignment Parameter” using the (VFO-A)[SELECT] knob per the chart below, then set the RF Signal Generator output to each level, and adjust the (VFO-B)[SELECT] knob for the corresponding Main S-meter deflection, then press the [ENT] key to save the new setting at each frequency.

ALIGNMENT PARAMETER	RF SIGNAL GENERATOR	MAIN S-METER
05-01 M-S0	OFF	S-0
05-02 M-S1	14 dB μ	S-1
05-03 M-S5	24 dB μ	S-5
05-04 M-S7	30 dB μ	S-7
05-05 M-S9	36 dB μ	S-9
05-06 M-S10	46 dB μ	S-9+10dB
05-07 M-S20	56 dB μ	S-9+20dB
05-08 M-S30	66 dB μ	S-9+30dB
05-09 M-S40	76 dB μ	S-9+40dB
05-10 M-S50	86 dB μ	S-9+50dB
05-11 M-S60	96 dB μ	S-9+60dB

- ❑ Press and hold in the [MENU] button for 2 seconds to save the new setting and exit from the alignment mode.

FILTER Gain Adjustment

- ❑ Set the following controls as indicated:
 - [IPO] button: AMP1
 - [ATT] button: OFF
 - [R.FLT] button: 3 kHz
 - [AGC] button: AUTO
 - [RF GAIN] knob: Fully clockwise
 - [FLT] button: THRU
- ❑ Connect the AF millivoltmeter to the “ANT 1” jack, then set the frequency to 14.200 MHz.
- ❑ Set the Main Band (VFO-A) frequency to 14.200 MHz in the CW mode.
- ❑ Press and hold in the [1(1.8)], [2(3.5)], and [3(7)] keys, while turning the radio on, to enter the alignment mode.
- ❑ Select the appropriate “Alignment Parameter” using the (VFO-A)[SELECT] knob per the chart below, then set the RF Signal Generator output to each level, and adjust the (VFO-B)[SELECT] knob for the corresponding Main S-meter deflection, then press the [ENT] key to save the new setting at each frequency.

ALIGNMENT PARAMETER	ROOFING FILTER	AF SIGNAL GENERATOR
06-01 M-RF300	300 Hz	0 dB (± 0.5 dB)
06-02 M-RF600	600 Hz	0 dB (± 0.5 dB)
06-03 M-RF3k	3 kHz	Confirm 0 dB
05-04 M-RF6k	6 kHz	0 dB (± 0.5 dB)
06-05 M-RF15k	15 kHz	0 dB (± 0.5 dB)

- ❑ Press and hold in the [MENU] button for 2 seconds to save the new setting and exit from the alignment mode.

FM Gain Adjustment

- ❑ Set the following controls as indicated:
 - [IPO] button: AMP1
 - [ATT] button: OFF
 - [R.FLT] button: 15 kHz
 - [AGC] button: AUTO
 - [RF GAIN] knob: Fully clockwise
 - [FLT] button: THRU
- ❑ Set the RF Signal Generator to 12 dB μ at 28.8500 MHz with ± 3.5 kHz deviation FM modulation of a 1 kHz audio signal.
- ❑ Set the Main Band (VFO-A) frequency to 28.850 MHz in the FM-W mode.
- ❑ Press and hold in the [1(1.8)], [2(3.5)], and [3(7)] keys, while turning the radio on, to enter the alignment mode.
- ❑ Rotate the (VFO-A)[SELECT] knob to select the alignment parameter "07-01 M-FMG28."
- ❑ Rotate the (VFO-B)[SELECT] knob so that the Main S-meter reading is "S-3."
- ❑ Press and hold in the [MENU] button for 2 seconds to save the new setting and exit from the alignment mode.
- ❑ Set the RF Signal Generator to 12 dB μ at 52.000 MHz with ± 3.5 kHz deviation FM modulation of a 1 kHz audio signal.
- ❑ Set the Main Band (VFO-A) frequency to 52.000 MHz in the FM-W mode.
- ❑ Press and hold in the [1(1.8)], [2(3.5)], and [3(7)] keys, while turning the radio on, to enter the alignment mode again.
- ❑ Rotate the Main Tuning Dial knob to select the alignment parameter "07-02 M-FMG50."
- ❑ Rotate the [SUB(VFO-B)] knob so that the Main S-meter reading is "S-3."
- ❑ Press and hold in the [MENU] button for 2 seconds to save the new setting and exit from the alignment mode.

Alignment

Sub Receiver Adjustment

1st Local Oscillator Adjustment

- Set the following controls as indicated:
 - [IPO] button: "Sub band (VFO-B)" AMP1
 - [ATT] button: "Sub band (VFO-B)" OFF
 - [FLT] button: "Sub band (VFO-B)" THRU
 - [R.FLT] button: "Sub band (VFO-B)" AUTO
 - [AGC] button: "Sub band (VFO-B)" AUTO
 - [RF GAIN] knob: "Sub band (VFO-B)"
Fully clockwise
 - [MODE] button: "Sub band (VFO-B)" CW
- Connect the RF millivoltmeter to TP1021 on the RX-1 Unit.
- Press and hold in the [1(1.8)], [2(3.5)], and [3(7)] keys, while turning the radio on, to enter the alignment mode.
- Select the appropriate "Alignment Parameter" using the (VFO-A)[SELECT] knob per the chart below, and adjust the (VFO-B)[SELECT] knob for the corresponding RF millivoltmeter reading at each frequency.

ALIGNMENT PARAMETER	VFO-A FREQUENCY	RF MILLIVOLTMETER
08-01 S-L1.8	1.850 MHz	0.70 Vrms (± 0.05 Vrms)
08-02 S-L3.5	3.750 MHz	0.70 Vrms (± 0.05 Vrms)
08-03 S-L7	7.100 MHz	0.70 Vrms (± 0.05 Vrms)
08-04 S-L14	14.200 MHz	0.70 Vrms (± 0.05 Vrms)
08-05 S-L21	21.200 MHz	0.70 Vrms (± 0.05 Vrms)
08-06 S-L28	28.700 MHz	0.70 Vrms (± 0.05 Vrms)
08-07 S-L50	51.500 MHz	0.70 Vrms (± 0.05 Vrms)

- Press and hold in the [MENU] button for 2 seconds to save the new setting and exit from the alignment mode.

2nd/3rd Local Level Adjustment

- Set the following controls as indicated:
 - [IPO] button: AMP1
 - [ATT] button: OFF
 - [FLT] button: THRU
 - [R.FLT] button: AUTO
 - [AGC] button: AUTO
 - [RF GAIN] knob: Fully clockwise
- Connect the RF millivoltmeter to TP1047 on the TRX Unit.
- Adjust T1037 on the TRX Unit for maximum deflection on the RF millivoltmeter (more than +9 dBm).
- Disconnect the RF millivoltmeter from TP1047.
- Connect the RF millivoltmeter to TP1048 on the RX-1 Unit.
- Adjust T1039 on the TRX Unit for maximum deflection on the RF millivoltmeter (more than +10 dBm).
- Disconnect the RF millivoltmeter from TP1048.

IF Transformer Adjustment

- Set the following controls as indicated:
 - [IPO] button: AMP1
 - [ATT] button: OFF
 - [FLT] button: THRU
 - [AGC] button: AUTO
 - [RF GAIN] knob: Fully clockwise
 - [MODE] button: CW
- Set the Sub Band (VFO-B) frequency to 14.200 MHz in the CW mode.
- Connect the AF millivoltmeter and 4 Ohm dummy load to the EXT SP jack.
- Connect the RF Signal Generator to the "ANT 1" jack, then set the output level to 0 dB μ at 14.200 MHz.
- Set the Roofing filter bandwidth to "3 kHz" by pressing the [R.FLT] Switch.
- Adjust T1022, T1027, T1038, T1029, T1036, T1040, T1028 and T1023 on the TRX Unit in succession several times for maximum deflection on the AF millivoltmeter.

If the Main S-meter deflects while adjusting, reduce the RF Signal Generator output so that the Main S-meter does not deflect.

- Set the Roofing filter bandwidth to "6 kHz" by pressing the [R.FLT] Switch.
- Adjust T1030 and T1035 on the TRX Unit in succession several times for maximum deflection on the AF millivoltmeter.

If the Main S-meter deflects while adjusting, reduce the RF Signal Generator output so that the Main S-meter does not deflect.

- Set the Roofing filter bandwidth to "15 kHz" by pressing the [R.FLT] Switch.
- Adjust T1034 on the TRX Unit in succession several times for maximum deflection on the AF millivoltmeter.

If the Main S-meter deflects while adjusting, reduce the RF Signal Generator output so that the Main S-meter does not deflect.

MCF Adjustment

- ❑ Set the following controls as indicated:
 [IPO] button: AMP2
 [ATT] button: OFF
 [FLT] button: THRU
 [R.FLT] button: AUTO
 [AGC] button: AUTO
 [RF GAIN] knob: Fully clockwise
- ❑ Set the Sub Band (VFO-B) frequency to 28.000 MHz in the FM-W mode.
- ❑ Connect the AC millivoltmeter, SINAD meter, and 4 Ohm dummy load to the EXT SP jack.
- ❑ Connect the RF Signal Generator to the "ANT 1" jack, then set the output level to 0 dB μ at 28.000 MHz.
- ❑ Set the Roofing filter bandwidth to "15 kHz" by pressing the [R.FLT] button.

- ❑ Adjust T1022, T3027, T3034, T1023 and T1028 on the TRX Unit in succession several times for maximum deflection on the SINAD meter.
 If the Main S-meter deflects while adjusting, reduce the RF Signal Generator output so that the Main S-meter does not deflect.
- ❑ Set the Sub Band (VFO-B) frequency to 28.000 MHz in the AM mode, and set the IPO to "AMP2" by pressing the [IPO] button.
- ❑ Set the Roofing filter bandwidth to "6 kHz" by pressing the [R.FLT] button, and set the IPO to "AMP2" by pressing the [IPO] button.
- ❑ Set the RF Signal Generator output to +36 dB μ (AM: 1kHz, 30%) at 28.000 MHz.
- ❑ Adjust T1030 and T1035 on the TRX Unit in succession several times for maximum deflection on the AF millivoltmeter.
 If the Main S-meter deflects while adjusting, reduce the RF Signal Generator output so that the Main S-meter does not deflect.

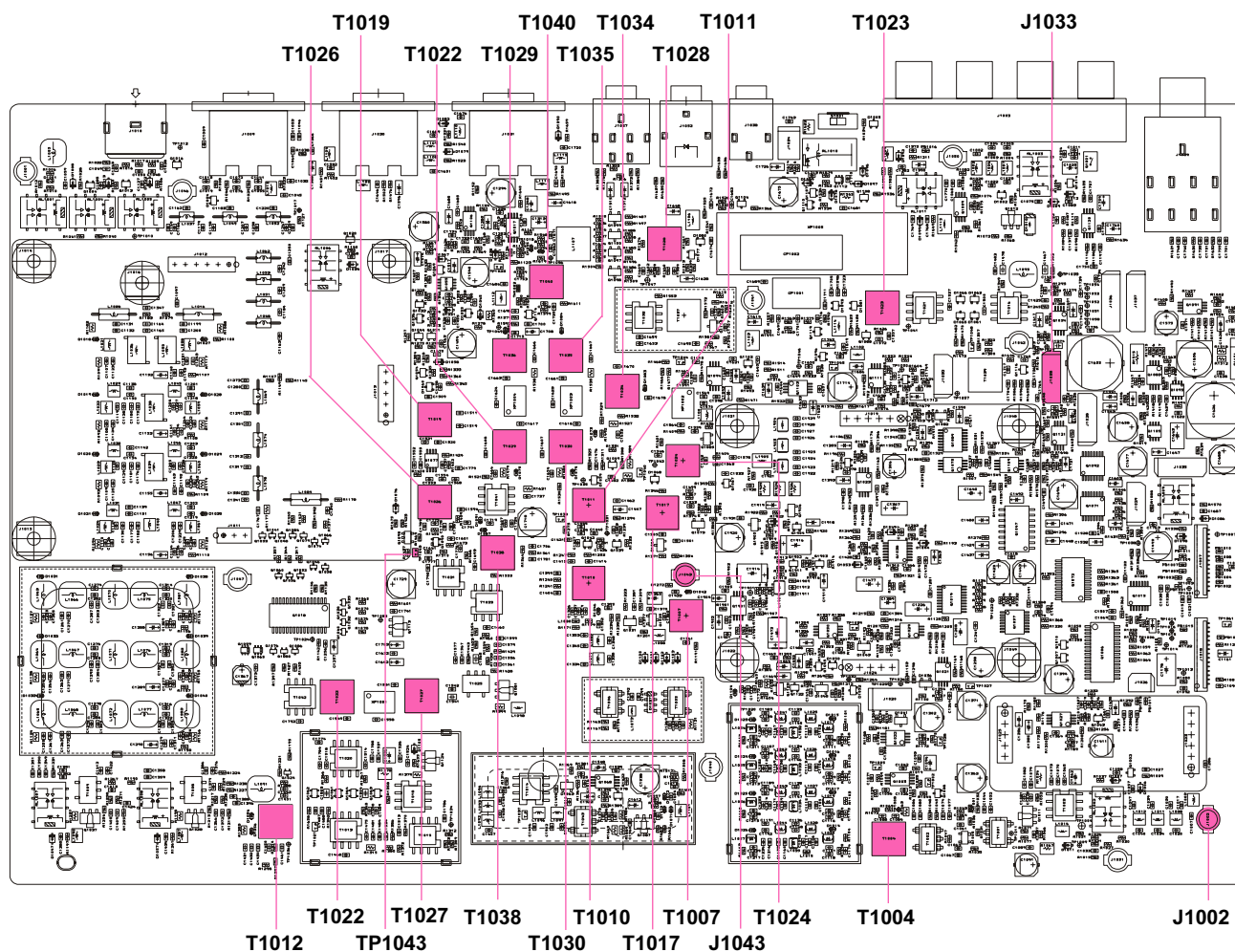

TRX UNIT ALIGNMENT POINTS

Alignment

Noise Blanker Circuit Adjustment

- ❑ Set the following controls as indicated:
 - [IPO] button: "Sub band (VFO-B)" AMP1
 - [ATT] button: "Sub band (VFO-B)" OFF
 - [R.FLT] button: "Sub band (VFO-B)" AUTO
 - [AGC] button: "Sub band (VFO-B)" AUTO
 - [NB] button: "Sub band (VFO-B)"
ON (for short-duration pulse noise)
 - [NB] "Sub band (VFO-B)" knob: 12 o' clock
 - [RF GAIN] knob: "Sub band (VFO-B)"
Fully clockwise
 - [FLT] button: "Sub band (VFO-B)" THRU
- ❑ Set the Sub Band (VFO-B) frequency to 14.200 MHz in the CW mode.
- ❑ Connect the DC voltmeter to TP1043 on the TRX Unit.
- ❑ Connect the RF Signal Generator to the "ANT 1" jack, then set the output level to 40 dB μ at 14.200 MHz.
- ❑ Adjust T1026 and T1019 on the TRX Unit for minimum deflection on the DC voltmeter.
- ❑ Turn the NB to "OFF" by pressing the [NB] button.
- ❑ Disconnect the RF millivoltmeter from TP1043.

IF Trap (40.455 MHz) Adjustment

- ❑ Set the following controls as indicated:
 - [IPO] button: AMP2
 - [ATT] button: OFF
 - [R.FLT] button: AUTO
 - [AGC] button: AUTO
 - [RF GAIN] knob: Fully clockwise
 - [VRF] button: THRU
- ❑ Set the Sub Band (VFO-B) frequency to 50.000 MHz in the CW mode.
- ❑ Connect the AC millivoltmeter and 4 Ohm dummy load to the EXT SP jack.
- ❑ Connect the RF Signal Generator to the "ANT 1" jack, then set the output level to 60 dB μ ~ 90 dB μ at 40.455 MHz.
- ❑ Adjust T1012 on the TRX Unit for minimum deflection on the AC millivoltmeter.
If the Main S-meter deflects while adjusting, reduce the RF Signal Generator output so that the Main S-meter does not deflect.

RF AGC Adjustment

- ❑ Set the following controls as indicated:
 - [IPO] button: "Sub band (VFO-B)" AMP1
 - [ATT] button: "Sub band (VFO-B)" OFF
 - [R.FLT] button: "Sub band (VFO-B)" AUTO
 - [AGC] button: "Sub band (VFO-B)" AUTO
 - [RF GAIN] knob: "Sub band (VFO-B)"
Fully clockwise
 - [FLT] button: "Sub band (VFO-B)" THRU
 - [MODE] button: "Sub band (VFO-B)" CW
- ❑ Connect the RF Signal Generator to the "ANT 1" jack, and connect the Digital DC voltmeter (high-Z) to J1033 pin 5 on the TRX Unit.
- ❑ Press and hold in the [1(1.8)], [2(3.5)], and [3(7)] keys, while turning the radio on, to enter the alignment mode.
- ❑ Select the appropriate "Alignment Parameter" using the (VFO-A)[SELECT] knob per the chart below, then set the RF Signal Generator output to each frequency & level, and adjust the (VFO-B)[SELECT] knob for the corresponding DC voltmeter reading at each frequency.

ALIGNMENT PARAMETER	RF SIGNAL GENERATOR	VFO-A FREQUENCY	DC VOLTMETER
09-01 S-RGC1.8	1.900 MHz, 76 dB μ	1.900 MHz	0.2 V ($\pm 0.05V$)
09-02 S-RGC3.5	3.750 MHz, 76 dB μ	3.750 MHz	0.2 V ($\pm 0.05V$)
09-03 S-RGC7	7.150 MHz, 76 dB μ	7.150 MHz	0.2 V ($\pm 0.05V$)
09-04 S-RGC10	10.125 MHz, 76 dB μ	10.125 MHz	0.2 V ($\pm 0.05V$)
09-05 S-RGC14	14.175 MHz, 76 dB μ	14.175 MHz	0.2 V ($\pm 0.05V$)
09-06 S-RGC18	18.117 MHz, 76 dB μ	18.117 MHz	0.2 V ($\pm 0.05V$)
09-07 S-RGC21	21.255 MHz, 76 dB μ	21.255 MHz	0.2 V ($\pm 0.05V$)
09-08 S-RGC24	24.940 MHz, 76 dB μ	24.940 MHz	0.2 V ($\pm 0.05V$)
09-09 S-RGC28	28.850 MHz, 76 dB μ	28.850 MHz	0.2 V ($\pm 0.05V$)
09-10 S-RGC50	52.000 MHz, 76 dB μ	52.000 MHz	0.2 V ($\pm 0.05V$)

- ❑ Press and hold in the [MENU] button for 2 seconds to save the new setting and exit from the alignment mode.

Alignment

FILTER Gain Adjustment

- ❑ Set the following controls as indicated:
 - [IPO] button: "Sub band (VFO-B)" AMP1
 - [ATT] button: "Sub band (VFO-B)" OFF
 - [R.FLT] button: "Sub band (VFO-B)" 3 kHz
 - [AGC] button: "Sub band (VFO-B)" AUTO
 - [RF GAIN] knob: "Sub band (VFO-B)"
Fully clockwise
 - [FLT] button: "Sub band (VFO-B)" THRU
- ❑ Connect the AF millivoltmeter to the "ANT 1" jack.
- ❑ Set the Sub Band (VFO-B) frequency to 14.200 MHz in the CW mode.
- ❑ Press and hold in the [1(1.8)], [2(3.5)], and [3(7)] keys, while turning the radio on, to enter the alignment mode.
- ❑ Select the appropriate "Alignment Parameter" using the (VFO-A)[SELECT] knob per the chart below, then set the RF Signal Generator output to each level, and adjust the (VFO-B)[SELECT] knob for the corresponding Main S-meter deflection, then press the [ENT] key to save the new setting at each frequency.

ALIGNMENT PARAMETER	ROOFING FILTER	AF SIGNAL GENERATOR
12-01 M-RF3k	3 kHz	Confirm 0 dB
12-02 M-RF6k	6 kHz	0 dB (± 0.5 dB)
12-03 M-RF15k	15 kHz	0 dB (± 0.5 dB)

- ❑ Press and hold in the [MENU] button for 2 seconds to save the new setting and exit from the alignment mode.

FM Gain Adjustment

- ❑ Set the following controls as indicated:
 - [IPO] button: AMP1
 - [ATT] button: OFF
 - [R.FLT] button: 15 kHz
 - [AGC] button: AUTO
 - [RF GAIN] knob: Fully clockwise
 - [FLT] button: THRU
- ❑ Set the RF Signal Generator to 12 dB μ at the 28.8500 MHz with ± 3.5 kHz deviation FM modulation of a 1 kHz audio signal.
- ❑ Set the Sub Band (VFO-B) frequency to 28.850 MHz in the FM-W mode.
- ❑ Press and hold in the [1(1.8)], [2(3.5)], and [3(7)] keys, while turning the radio on, to enter the alignment mode.
- ❑ Rotate the (VFO-A)[SELECT] knob to select the alignment parameter "13-01 S-FMG28."
- ❑ Rotate the (VFO-B)[SELECT] knob so that the Main S-meter reading is "S-3."
- ❑ Press and hold in the [MENU] button for 2 seconds to save the new setting and exit from the alignment mode.
- ❑ Set the RF Signal Generator to 12 dB μ at 52.000 MHz with ± 3.5 kHz deviation FM modulation of a 1 kHz audio signal.
- ❑ Set the Sub Band (VFO-B) frequency to 52.000 MHz in the FM-W mode.
- ❑ Press and hold in the [1(1.8)], [2(3.5)], and [3(7)] keys, while turning the radio on, to enter the alignment mode again.
- ❑ Rotate the Main Tuning Dial knob to select the alignment parameter "13-02 S-FMG50."
- ❑ Rotate the [SUB(VFO-B)] knob so that the Main S-meter reading is "S-3."
- ❑ Press and hold in the [MENU] button for 2 seconds to save the new setting and exit from the alignment mode.

Transmitter Adjustment

TX IFT Adjustment

- ❑ Disconnect the coaxial cable from J1002 on the MAIN Unit, then connect the RF millivoltmeter to J1002.
- ❑ Set the Main Band (VFO-A) frequency to 14.200 MHz in the FM mode, then rotate the [RF PWR] knob to the fully clockwise position.
- ❑ Press the PTT button and then adjust T1024, T1017, T1011 and T1010 for maximum deflection on the RF millivoltmeter.
- ❑ Release the PTT button.
- ❑ Disconnect the RF millivoltmeter from J1002, then re-connect the coaxial cable to J1002.

TX Scope Circuit Adjustment

- ❑ Disconnect the coaxial cable from J1043 on the TRX Unit, then connect the RF millivoltmeter to J1043.
- ❑ Set the Main Band (VFO-A) frequency to 14.200 MHz in the CW mode, then rotate the [RF PWR] knob to the fully clockwise position.

- ❑ Press the PTT button and then adjust T1007 for maximum deflection on the RF millivoltmeter.
- ❑ Release the PTT button.
- ❑ Disconnect the RF millivoltmeter from J1043, then re-connect the coaxial cable to J1043.

IFT Adjustment

- ❑ Disconnect the coaxial cable from J1002 on the MAIN Unit, then connect the RF millivoltmeter to J1002.
- ❑ Set the Main Band (VFO-A) frequency to 50.000 MHz in the FM mode, then rotate the [RF PWR] knob to the fully clockwise position.
- ❑ Press the PTT button and then adjust T1004 on the Spurious for minimum deflection on the Spectrum Analyzer.
- ❑ Release the PTT button.
- ❑ Disconnect the RF millivoltmeter from J1002, then re-connect the coaxial cable to J1002.

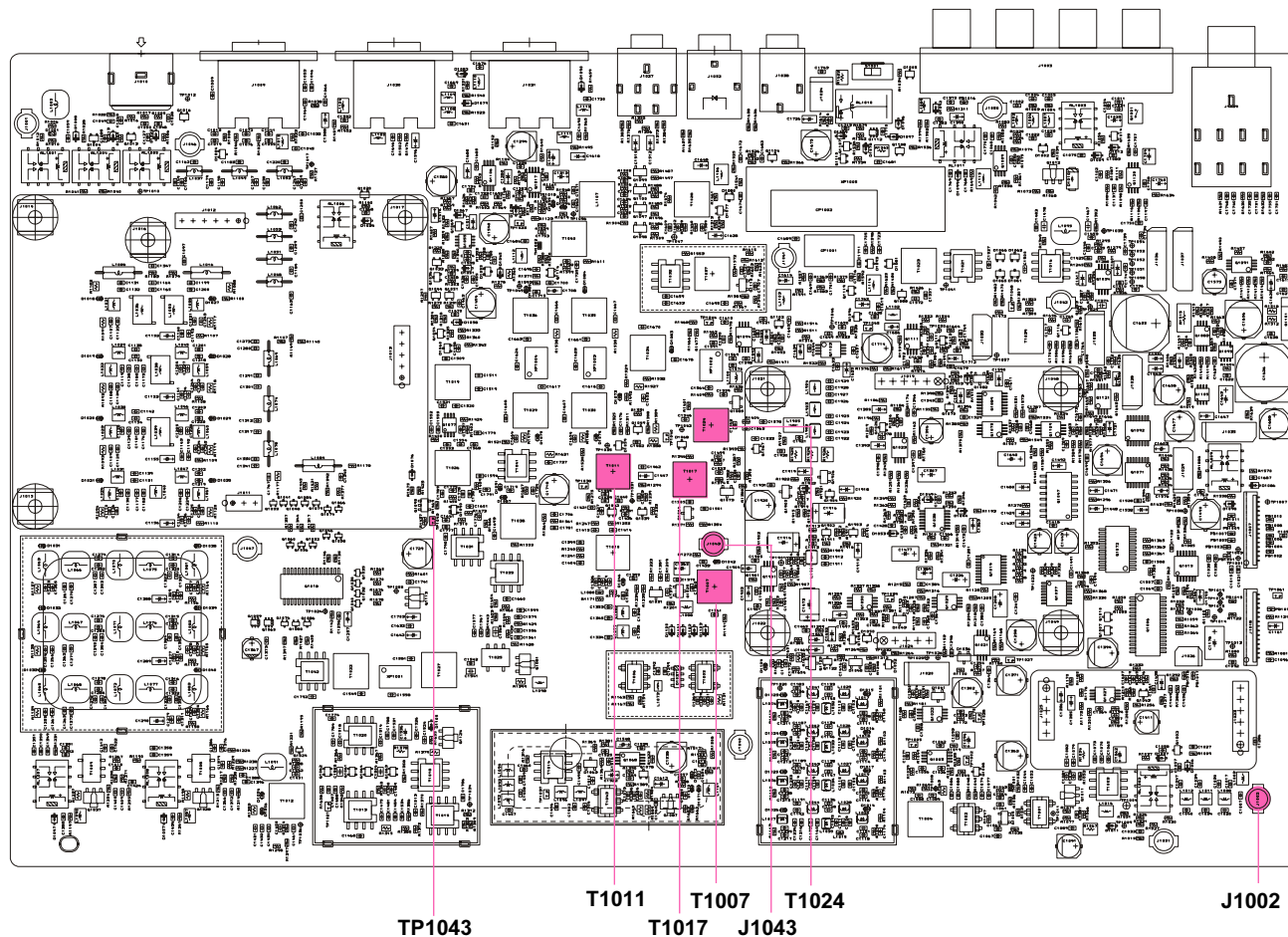

TRX UNIT ALIGNMENT POINTS

Alignment

PA-B Unit Adjustment

Preparation

- ❑ Disconnect the coaxial cables from J5501 and J5517 on the PA-B Unit, then terminate J5501 and J5517 with 50-Ohm resistors.
- ❑ Disconnect the jumper plugs from J5531 and J5004 on the PA-B Unit.

Pre-Drive Stage Idling Current Adjustment

- ❑ Connect the DC ammeter to J5531 on the PA-B Unit.
- ❑ Press and hold in the [1(1.8)], [2(3.5)], and [3(7)] keys, while turning the radio on, to enter the alignment mode.
- ❑ Rotate the Main Tuning Dial knob to select the alignment parameter "14-01 PDR-BIAS."
- ❑ Press the PTT button and then adjust the (VFO-B)[SELECT] knob so that the DC ammeter reading is "50 mA (± 5 mA)."
- ❑ Release the PTT button.

Drive Stage Idling Current Adjustment

- ❑ Disconnect the 13.8 V Power cable from J5531.
- ❑ Connect the DC ammeter between J5531.
- ❑ Rotate the (VFO-A)[SELECT] knob to select the alignment parameter "14-02 DR1-BIAS."
- ❑ Press the PTT button and then adjust the (VFO-B)[SELECT] knob so that the DC ammeter reading is "700 mA (± 50 mA)."
- ❑ Release the PTT button.
- ❑ Rotate the (VFO-A)[SELECT] knob to select the alignment parameter "14-03 DR2-BIAS."
- ❑ Rotate the (VFO-B)[SELECT] knob so that the VFO-B frequency display shows "0."

Final Stage Idling Current Adjustment

- ❑ Connect the DC ammeter between J0006 (pin 2) and Pin 2 Connector on the PS Unit.
- ❑ Rotate the (VFO-A)[SELECT] knob to select the alignment parameter "14-04 F1-BAIAS."
- ❑ Press the PTT button and then adjust the (VFO-B)[SELECT] knob so that the DC ammeter reading is "500 mA (± 50 mA)."
- ❑ Release the PTT button.
- ❑ Rotate the (VFO-A)[SELECT] knob to select the alignment parameter "14-05 F2-BAIAS."
- ❑ Press the PTT button and then adjust the (VFO-B)[SELECT] knob so that the DC ammeter reading is "500 A (± 50 mA)."
- ❑ Release the PTT button.

CLASS-A Final Stage Idling Current Adjustment

- ❑ Connect the DC ammeter between J0006 (pin 2) and Pin 2 Connector on the PS Unit.
- ❑ Rotate the (VFO-A)[SELECT] knob to select the alignment parameter "14-06 F1A-BAIAS."
- ❑ Press the PTT button and then adjust the [SUB(VFO-B)] knob so that the DC ammeter reading is "3.3 A (± 0.1 A)."
- ❑ Release the PTT button.
- ❑ Rotate the (VFO-A)[SELECT] knob to select the alignment parameter "14-07 F2A-BAIAS."
- ❑ Press the PTT button and then adjust the (VFO-B)[SELECT] knob so that the DC ammeter reading is "3.0 A (± 0.1 A)."
- ❑ Release the PTT button.

Termination

- ❑ Press and hold in the [MENU] button for 2 seconds to save the new setting and exit from the alignment mode.
- ❑ Disconnect the 50-Ohm resistors from J5501 and J5517, then connect the coaxial cables to J5501 and J5517.

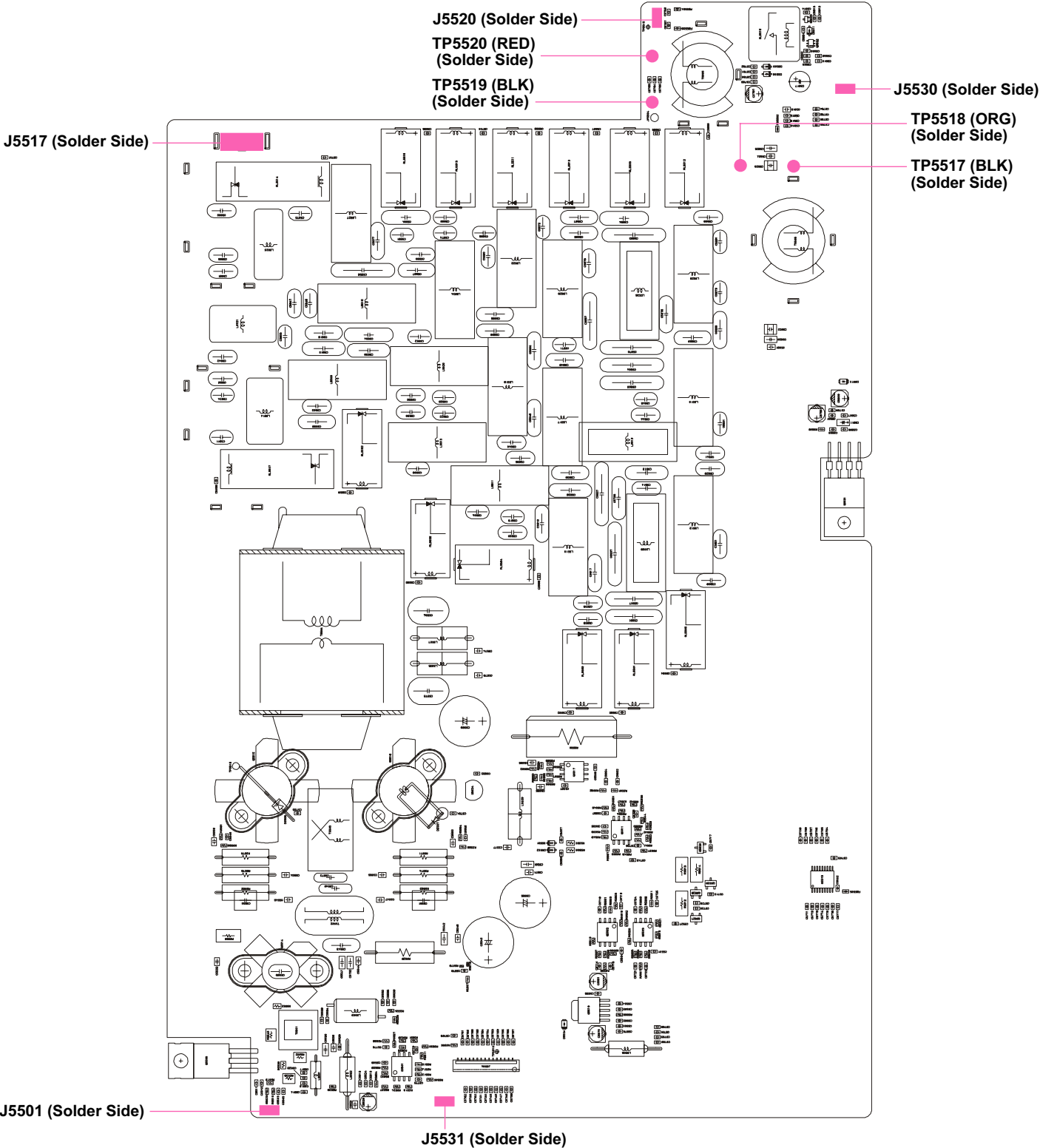

PA-B UNIT (200 W TYPE) ALIGNMENT POINTS

Alignment

Transmitter Section Alignment Mode

Preparation

- ❑ Referring to table below, tune the Main Band (VFO-A) to each frequency listed.

BAND	VFO-A FREQUENCY	MODE
1.8 MHz Band	1.820 MHz	USB
3.5 MHz Band	3.570 MHz	USB
7 MHz Band	7.050 MHz	USB
10 MHz Band	10.100 MHz	USB
14 MHz Band	14.200 MHz	USB
18 MHz Band	18.100 MHz	USB
21 MHz Band	21.200 MHz	USB
24.5 MHz Band	24.900 MHz	USB
28 MHz Band	28.010 MHz	USB
50 MHz Band	53.900 MHz	USB

- ❑ Connect the 50-Ohm Dummy Load and Wattmeter to the “ANT 1” jack.
- ❑ Connect the Audio Generator to pin 8 of the MIC jack (pin 7: GND), then set the output level to 0.5 mV @1 kHz.

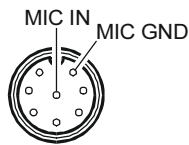

ALC Adjustment

- ❑ Press and hold in the [1(1.8)], [2(3.5)], and [3(7)] keys, while turning the radio on, to enter the alignment mode.
- ❑ Rotate the (VFO-A)[SELECT] knob to select the alignment parameter “15-01 IALC1.8” for the 1.8 MHz amateur band ALC Adjustment, then rotate the (VFO-B)[SELECT] knob so that the VFO-B frequency display shows “020.”
- ❑ Rotate the [MIC] knob to the fully counter-clockwise position.
- ❑ Press the PTT switch, then gently rotate the [MIC] knob to the fully clockwise position.
- ❑ Rotate the (VFO-B)[SELECT] knob for 240 W (+10W/-0W) on the Wattmeter.
- ❑ Release the PTT switch.
- ❑ Rotate the (VFO-A)[SELECT] knob to select the alignment parameter “15-02 IALC3.5” for the 3.5 MHz amateur band ALC Adjustment, then rotate the (VFO-B)[SELECT] knob so that the VFO-B frequency display shows “020.”
- ❑ Rotate the [MIC] knob to the fully counter-clockwise position.
- ❑ Press the PTT switch and then gently rotate the [MIC] knob to the fully clockwise position.
- ❑ Rotate the [SUB(VFO-B)] knob for 240 W (+10W/-0W) on the Wattmeter.
- ❑ Release the PTT switch.
- ❑ Rotate the (VFO-A)[SELECT] knob to select the alignment parameter “15-03 IALC7” for the 7 MHz amateur band ALC Adjustment, then ro-

tate the (VFO-B)[SELECT] knob so that the VFO-B frequency display shows “020.”

- ❑ Rotate the [MIC] knob to the fully counter-clockwise position.
- ❑ Press the PTT switch and then gently rotate the [MIC] knob to the fully clockwise position.
- ❑ Rotate the (VFO-B)[SELECT] knob for 240 W (+10W/-0W) on the Wattmeter.
- ❑ Release the PTT switch.
- ❑ Rotate the (VFO-A)[SELECT] knob to select the alignment parameter “15-04 IALC10” for the 10 MHz amateur band’s ALC Adjustment, then rotate the (VFO-B)[SELECT] knob so that the VFO-B frequency display shows “020.”
- ❑ Rotate the [MIC] knob to the fully counter-clockwise position.
- ❑ Press the PTT switch and then gently rotate the [MIC] knob to the fully clockwise position.
- ❑ Rotate the (VFO-B)[SELECT] knob for 220 W (+10W/-0W) on the Wattmeter.
- ❑ Release the PTT switch.
- ❑ Rotate the (VFO-A)[SELECT] knob to select the alignment parameter “15-05 IALC14” for the 14 MHz amateur band ALC Adjustment, then rotate the (VFO-B)[SELECT] knob so that the VFO-B frequency display shows “020.”
- ❑ Rotate the [MIC] knob to the fully counter-clockwise position.
- ❑ Press the PTT switch and then gently rotate the [MIC] knob to the fully clockwise position.
- ❑ Rotate the (VFO-B)[SELECT] knob for 240 W (+10W/-0W) on the Wattmeter.
- ❑ Release the PTT switch.
- ❑ Rotate the (VFO-A)[SELECT] knob to select the alignment parameter “15-06 IALC18” for the 18 MHz amateur band ALC Adjustment, then rotate the (VFO-B)[SELECT] knob so that the VFO-B frequency display shows “020.”
- ❑ Rotate the [MIC] knob to the fully counter-clockwise position.
- ❑ Press the PTT switch and then gently rotate the [MIC] knob to the fully clockwise position.
- ❑ Rotate the (VFO-B)[SELECT] knob for 240 W (+10W/-0W) on the Wattmeter.
- ❑ Release the PTT switch.
- ❑ Rotate the (VFO-A)[SELECT] knob to select the alignment parameter “15-07 IALC21” for the 21 MHz amateur band ALC Adjustment, then rotate the (VFO-B)[SELECT] knob so that the VFO-B frequency display shows “020.”

- ❑ Rotate the [MIC] knob to the fully counter-clockwise position.
- ❑ Press the PTT switch and then gently rotate the [MIC] knob to the fully clockwise position.
- ❑ Rotate the (VFO-B)[SELECT] knob for 240 W (+10W/-0W) on the Wattmeter.
- ❑ Release the PTT switch.
- ❑ Rotate the (VFO-A)[SELECT] knob to select the alignment parameter “15-08 IALC24” for the 24 MHz amateur band ALC Adjustment, then rotate the (VFO-B)[SELECT] knob so that the VFO-B frequency display shows “020.”
- ❑ Rotate the [MIC] knob to the fully counter-clockwise position.
- ❑ Press the PTT switch and then gently rotate the [MIC] knob to the fully clockwise position.
- ❑ Rotate the (VFO-B)[SELECT] knob for 240 W (+10W/-0W) on the Wattmeter.
- ❑ Release the PTT switch.
- ❑ Rotate the (VFO-A)[SELECT] knob to select the alignment parameter “15-09 IALC28” for the 28 MHz amateur band ALC Adjustment, then rotate the (VFO-B)[SELECT] knob so that the VFO-B frequency display shows “020.”
- ❑ Rotate the [MIC] knob to the fully counter-clockwise position.
- ❑ Press the PTT switch and then gently rotate the [MIC] knob to the fully clockwise position.
- ❑ Rotate the (VFO-B)[SELECT] knob for 240 W (+10W/-0W) on the Wattmeter.
- ❑ Release the PTT switch.
- ❑ Rotate the (VFO-A)[SELECT] knob to select the alignment parameter “15-10 IALC50” for the 50 MHz amateur band ALC Adjustment, then rotate the (VFO-B)[SELECT] knob so that the VFO-B frequency display shows “020.”
- ❑ Rotate the [MIC] knob to the fully counter-clockwise position.
- ❑ Press the PTT switch and then gently rotate the [MIC] knob to the fully clockwise position.
- ❑ Rotate the (VFO-B)[SELECT] knob for 240 W (+10W/-0W) on the Wattmeter.
- ❑ Release the PTT switch.
- ❑ Press and hold in the [MENU] button for 2 seconds to save the new setting and exit from the alignment mode.

Power Adjustment

- ❑ Connect the 50-Ohm Dummy Load and Wattmeter to the “ANT 1” jack.
- ❑ Rotate the [RF PWR] knob to fully clockwise.
- ❑ Set the Main Band (VFO-A) frequency to 14.200 MHz in the CW mode.
- ❑ Press and hold in the [1(1.8)], [2(3.5)], and [3(7)] keys, while turning the radio on, to enter the alignment mode.
- ❑ Rotate the (VFO-A)[SELECT] knob to select the alignment parameter “20-01 200F14.”
- ❑ Rotate the (VFO-B)[SELECT] knob so that the VFO-B frequency display shows “0.”
- ❑ Press the PTT switch, rotate the (VFO-B)[SELECT] knob for 200 W (+10W/-0W) on the Wattmeter, and confirm that the Sub S-meter deflects.
- ❑ Release the PTT switch.
- ❑ Press and hold in the [MENU] button for 2 seconds to save the new setting and exit from the alignment mode.

ALC Meter Adjustment

- ❑ Connect the 50-Ohm Dummy Load and Wattmeter to the “ANT 1” jack.
- ❑ Connect the Audio Generator to pin 8 of the MIC jack (pin 7: GND), then set the output level to +0 mV @1 kHz.
- ❑ Set the Main Band (VFO-A) frequency to 14.200 MHz in the USB mode.
- ❑ Rotate the [MIC] knob to the 12 o’clock position, and rotate the [RF PWR] knob to the fully clockwise position.
- ❑ Press and hold in the [1(1.8)], [2(3.5)], and [3(7)] keys, while turning the radio on, to enter the alignment mode.
- ❑ Rotate the (VFO-A)[SELECT] knob to select the alignment parameter “29-01 ALCMTR.”
- ❑ Press the PTT switch and adjust the Audio Generator output level to the position where the ALC meter just starts to deflect.
- ❑ Release the PTT switch, and increase the Audio Generator output level for “12 dB.”
- ❑ Press the [ENT] key, *while pressing and holding in the PTT switch* and rotate the (VFO-B)[SELECT] knob for maximum deflection in the ALC meter zone (S9+10dB).
- ❑ Release the PTT switch, then press and hold in the [MENU] button for 2 seconds to save the new setting and exit from the alignment mode.



Alignment

SSB TX IFGAIN (CAR) Adjustment

- ❑ Press and hold in the [1(1.8)], [2(3.5)], and [3(7)] keys, while turning the radio on, to enter the alignment mode.
- ❑ Rotate the (VFO-A)[SELECT] knob to select the alignment parameter “26-01 TCAR USB.”
- ❑ Rotate the (VFO-B)[SELECT] knob so that the VFO-B frequency display shows “255.”
- ❑ Press and hold in the [MENU] button for 2 seconds to save the new setting and exit from the alignment mode.

TX Output Power/PO Meter/TXG Adjustment

- ❑ Referring to table below, tune the transceiver to each frequency listed.

BAND	VFO-A FREQUENCY	MODE
1.8 MHz Band	1.820 MHz	CW
3.5 MHz Band	3.570 MHz	CW
7 MHz Band	7.050 MHz	CW
10 MHz Band	10.100 MHz	CW
14 MHz Band	14.200 MHz	CW
18 MHz Band	18.100 MHz	CW
21 MHz Band	21.200 MHz	CW
24.5 MHz Band	24.900 MHz	CW
28 MHz Band	28.700 MHz	CW
50 MHz Band	52.000 MHz	CW

- ❑ Connect the 50-Ohm Dummy Load and Wattmeter to the “ANT 1” jack.
- ❑ Set the Main Band (VFO-A) frequency to 1.820 MHz in the CW mode.
- ❑ Press and hold in the [1(1.8)], [2(3.5)], and [3(7)] keys, while turning the radio on, to enter the alignment mode.
- ❑ Rotate the (VFO-A)[SELECT] knob to select the alignment parameter “16-01 200F1.8.”
- ❑ Press the PTT switch and rotate the (VFO-B)[SELECT] knob for 200W (+10W/-0W) on the Wattmeter.
- ❑ Rotate the (VFO-A)[SELECT] knob to select the alignment parameter “16-02 200M1.8.”
- ❑ Rotate the (VFO-B)[SELECT] knob for 200W on the PO meter.
- ❑ Rotate the (VFO-A)[SELECT] knob to select the alignment parameter “16-03 200T1.8.”
- ❑ Rotate the (VFO-B)[SELECT] knob so that the ALC-meter deflects to maximum.
- ❑ Release the PTT switch.

- ❑ Rotate the (VFO-A)[SELECT] knob to select the alignment parameter “16-04 100F1.8.”
- ❑ Press the PTT switch and rotate the (VFO-B)[SELECT] knob for 100W (+5W/-0W) on the Wattmeter.
- ❑ Rotate the (VFO-A)[SELECT] knob to select the alignment parameter “16-05 100M1.8.”
- ❑ Rotate the (VFO-B)[SELECT] knob for 100W on the PO meter.
- ❑ Rotate the (VFO-A)[SELECT] knob to select the alignment parameter “16-06 100T1.8.”
- ❑ Rotate the (VFO-B)[SELECT] knob so that the ALC-meter deflects to maximum.
- ❑ Release the PTT switch.
- ❑ Rotate the (VFO-A)[SELECT] knob to select the alignment parameter “16-07 50F1.8.”
- ❑ Press the PTT switch and rotate the (VFO-B)[SELECT] knob for 50W (+5W/-0W) on the Wattmeter.
- ❑ Rotate the (VFO-A)[SELECT] knob to select the alignment parameter “16-08 50M1.8.”
- ❑ Rotate the (VFO-B)[SELECT] knob for 200W on the PO meter.
- ❑ Rotate the (VFO-A)[SELECT] knob to select the alignment parameter “16-09 50T1.8.”
- ❑ Rotate the (VFO-B)[SELECT] knob so that the ALC-meter deflects to maximum.
- ❑ Release the PTT switch.
- ❑ Rotate the (VFO-A)[SELECT] knob to select the alignment parameter “16-10 20F1.8.”
- ❑ Press the PTT switch and rotate the (VFO-B)[SELECT] knob for 20W (+2W/-0W) on the Wattmeter.
- ❑ Rotate the (VFO-A)[SELECT] knob to select the alignment parameter “16-11 20M1.8.”
- ❑ Rotate the (VFO-B)[SELECT] knob for 20W on the PO meter.
- ❑ Rotate the (VFO-A)[SELECT] knob to select the alignment parameter “16-12 20T1.8.”
- ❑ Rotate the (VFO-B)[SELECT] knob so that the ALC-meter deflects to maximum.
- ❑ Release the PTT switch.

- ❑ Rotate the (VFO-A)[SELECT] knob to select the alignment parameter “16-13 10F1.8.”
- ❑ Press the PTT switch and rotate the (VFO-B)[SELECT] knob for 10W (+1W/-0W) on the Wattmeter.
- ❑ Rotate the (VFO-A)[SELECT] knob to select the alignment parameter “16-14 10M1.8.”
- ❑ Rotate the (VFO-B)[SELECT] knob for 10W on the PO meter.
- ❑ Rotate the (VFO-A)[SELECT] knob to select the alignment parameter “16-15 10T1.8.”
- ❑ Rotate the (VFO-B)[SELECT] knob so that the ALC-meter deflects to maximum.
- ❑ Release the PTT switch.
- ❑ Perform the same procedures for the Alignment Menus “17-01 200F3.5” through “25-10T50,” per the chart below.

	ALIGNMENT MENU			WATTMETER	PO METER	ALC-METER
1.9 MHz	16-01 200F1.8	16-02 200M1.8	16-03 200T1.8	200 W (+10 W/-0 W)	200 W	maximum
	16-04 100F1.8	16-05 100M1.8	16-06 100T1.8	100 W (+5 W/-0 W)	100 W	maximum
	16-07 50F1.8	16-08 50M1.8	16-09 50T1.8	50 W (+5 W/-0 W)	50 W	maximum
	16-10 20F1.8	16-11 20M1.8	16-12 20T1.8	20 W (+2 W/-0 W)	20 W	maximum
	16-13 10F1.8	16-14 10M1.8	16-15 10T1.8	10 W (+1 W/-0 W)	10 W	maximum
3.5 MHz	17-01 200F3.5	17-02 200M3.5	17-03 200T3.5	200 W (+10 W/-0 W)	200 W	maximum
	17-04 100F3.5	17-05 100M3.5	17-06 100T3.5	100 W (+5 W/-0 W)	100 W	maximum
	17-07 50F3.5	17-08 50M3.5	17-09 50T3.5	50 W (+5 W/-0 W)	50 W	maximum
	17-10 20F3.5	17-11 20M3.5	17-12 20T3.5	20 W (+2 W/-0 W)	20 W	maximum
	17-13 10F3.5	17-14 10M3.5	17-15 10T3.5	10 W (+1 W/-0 W)	10 W	maximum
7 MHz	18-01 200F7	18-02 200M7	18-03 200T7	200 W (+10 W/-0 W)	200 W	maximum
	18-04 100F7	18-05 100M7	18-06 100T7	100 W (+5 W/-0 W)	100 W	maximum
	18-07 50F7	18-08 50M7	18-09 50T7	50 W (+5 W/-0 W)	50 W	maximum
	18-10 20F7	18-11 20M7	18-12 20T7	20 W (+2 W/-0 W)	20 W	maximum
	18-13 10F7	18-14 10M7	18-15 10T7	10 W (+1 W/-0 W)	10 W	maximum
10 MHz	19-01 200F10	19-02 200M10	19-03 200T10	200 W (+10 W/-0 W)	200 W	maximum
	19-04 100F10	19-05 100M10	19-06 100T10	100 W (+5 W/-0 W)	100 W	maximum
	19-07 50F10	19-08 50M10	19-09 50T10	50 W (+5 W/-0 W)	50 W	maximum
	19-10 20F10	19-11 20M10	19-12 20T10	20 W (+2 W/-0 W)	20 W	maximum
	19-13 10F10	19-14 10M10	19-15 10T10	10 W (+1 W/-0 W)	10 W	maximum
14 MHz	20-01 200F14	20-02 200M14	20-03 200T14	200 W (+10 W/-0 W)	200 W	maximum
	20-04 100F14	20-05 100M14	20-06 100T14	100 W (+5 W/-0 W)	100 W	maximum
	20-07 50F14	20-08 50M14	20-09 50T14	50 W (+5 W/-0 W)	50 W	maximum
	20-10 20F14	20-11 20M14	20-12 20T14	20 W (+2 W/-0 W)	20 W	maximum
	20-13 10F14	20-14 10M14	20-15 10T14	10 W (+1 W/-0 W)	10 W	maximum
18 MHz	21-01 200F18	21-02 200M18	21-03 200T18	200 W (+10 W/-0 W)	200 W	maximum
	21-04 100F18	21-05 100M18	21-06 100T18	100 W (+5 W/-0 W)	100 W	maximum
	21-07 50F18	21-08 50M18	21-09 50T18	50 W (+5 W/-0 W)	50 W	maximum
	21-10 20F18	21-11 20M18	21-12 20T18	20 W (+2 W/-0 W)	20 W	maximum
	21-13 10F18	21-14 10M18	21-15 10T18	10 W (+1 W/-0 W)	10 W	maximum
21 MHz	22-01 200F21	22-02 200M21	22-03 200T21	200 W (+10 W/-0 W)	200 W	maximum
	22-04 100F21	22-05 100M21	22-06 100T21	100 W (+5 W/-0 W)	100 W	maximum
	22-07 50F21	22-08 50M21	22-09 50T21	50 W (+5 W/-0 W)	50 W	maximum
	22-10 20F21	22-11 20M21	22-12 20T21	20 W (+2 W/-0 W)	20 W	maximum
	22-13 10F21	22-14 10M21	22-15 10T21	10 W (+1 W/-0 W)	10 W	maximum
24 MHz	23-01 200F24	23-02 200M24	23-03 200T24	200 W (+10 W/-0 W)	200 W	maximum
	23-04 100F24	23-05 100M24	23-06 100T24	100 W (+5 W/-0 W)	100 W	maximum
	23-07 50F24	23-08 50M24	23-09 50T24	50 W (+5 W/-0 W)	50 W	maximum
	23-10 20F24	23-11 20M24	23-12 20T24	20 W (+2 W/-0 W)	20 W	maximum
	23-13 10F24	23-14 10M24	23-15 10T24	10 W (+1 W/-0 W)	10 W	maximum
28 MHz	24-01 200F28	24-02 200M28	24-03 200T28	200 W (+10 W/-0 W)	200 W	maximum
	24-04 100F28	24-05 100M28	24-06 100T28	100 W (+5 W/-0 W)	100 W	maximum
	24-07 50F28	24-08 50M28	24-09 50T28	50 W (+5 W/-0 W)	50 W	maximum
	24-10 20F28	24-11 20M28	24-12 20T28	20 W (+2 W/-0 W)	20 W	maximum
	24-13 10F28	24-14 10M28	24-15 10T28	10 W (+1 W/-0 W)	10 W	maximum
50 MHz	25-01 200F50	25-02 200M50	25-03 200T50	200 W (+10 W/-0 W)	200 W	maximum
	25-04 100F50	25-05 100M50	25-06 100T50	100 W (+5 W/-0 W)	100 W	maximum
	25-07 50F50	25-08 50M50	25-09 50T50	50 W (+5 W/-0 W)	50 W	maximum
	25-10 20F50	25-11 20M50	25-12 20T50	20 W (+2 W/-0 W)	20 W	maximum
	25-13 10F50	25-14 10M50	25-15 10T50	10 W (+1 W/-0 W)	10 W	maximum

CM Coupler Balance Adjustment

- ❑ Connect the Digital DC voltmeter (high-Z) to pin 3 of J6002 on the TUNER Unit.
- ❑ Turn off the [TUNE] switch, then set the Main band (VFO-A) frequency to 24.900 MHz in the FM mode.
- ❑ Press the PTT switch and rotate the [RF PWR] knob for 50 Watts on the Wattmeter.
- ❑ Adjust TC6001 on the TUNER-MAIN Unit for minimum deflection on the DC voltmeter.

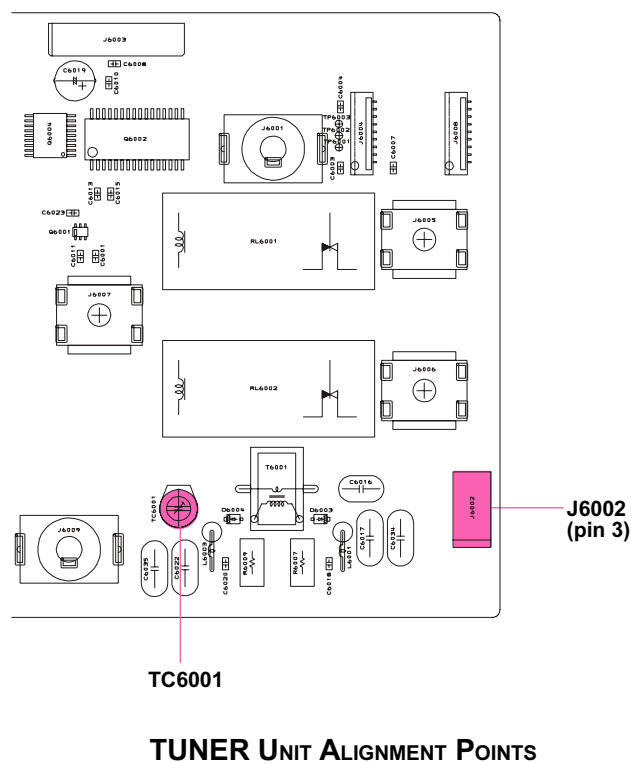

Alignment

CLASS-A/TXG Adjustment

- Connect the 50-Ohm Dummy Load and Wattmeter to the "ANT 1" jack.
- Rotate the [RF PWR] knob to fully clockwise.
- Set the Main Band (VFO-A) frequency to 1.820 MHz in the CW-U mode.
- Press and hold in the [1(1.8)], [2(3.5)], and [3(7)] keys, while turning the radio on, to enter the alignment mode.
- Rotate the (VFO-A)[SELECT] knob to select the alignment parameter "27-01 CLA1.8."
- Rotate the (VFO-B)[SELECT] knob so that the VFO-B frequency display shows "0."
- Press the PTT switch without microphone input, then rotate the (VFO-B)[SELECT] knob for 75 W (± 5 W) on the Wattmeter.
- Release the PTT switch.
- Perform the same procedures for the Alignment Menus "27-02 CAL3.5" through "27-10 CAL50."
- Press and hold in the [MENU] button for 2 seconds to save the new setting and exit from the alignment mode.

ALIGNMENT MENU	ALIGNMENT MENU	MODE	WATTMETER
27-01 CAL1.8	1.820 MHz	CW-U	75 W ± 5 W
27-02 CAL3.5	3.570 MHz	CW-U	75 W ± 5 W
27-03 CAL7	7.050 MHz	CW-U	75 W ± 5 W
27-04 CAL10	10.100 MHz	CW-U	75 W ± 5 W
27-05 CAL14	14.200 MHz	CW-U	75 W ± 5 W
27-06 CAL18	18.100 MHz	CW-U	75 W ± 5 W
27-07 CAL21	21.200 MHz	CW-U	75 W ± 5 W
27-08 CAL24	24.900 MHz	CW-U	75 W ± 5 W
27-09 CAL28	29.690 MHz	CW-U	75 W ± 5 W
27-10 CAL50	53.900 MHz	CW-U	75 W ± 5 W

AM TX GAIN (CAR) Adjustment

- Connect the 50-Ohm Dummy Load and Wattmeter to the "ANT 1" jack.
- Rotate the [RF PWR] knob to fully clockwise.
- Set the Main Band (VFO-A) frequency to 14.200 MHz in the AM mode.
- Press and hold in the [1(1.8)], [2(3.5)], and [3(7)] keys, while turning the radio on, to enter the alignment mode.
- Rotate the Main Tuning Dial knob to select the alignment parameter "26-02 TCAR AM."
- Rotate the (VFO-B)[SELECT] knob so that the VFO-B frequency display shows "0."
- Press the PTT switch without microphone input, then rotate the (VFO-B)[SELECT] knob for 75 W (± 5 W) on the Wattmeter.
- Release the PTT switch.
- Press the [ENT] key, and then release the PTT switch.

- Press and hold in the [MENU] button for 2 seconds to save the new setting and exit from the alignment mode.

Class-A TX GAIN (CAR) Adjustment

- Connect the 50-Ohm Dummy Load and Wattmeter to the "ANT 1" jack, then set the METER switch to the "ALC" position.
- Set the Main Band (VFO-A) frequency to 14.200 MHz in the CW-U mode.
- Press and hold in the [1(1.8)], [2(3.5)], and [3(7)] keys, while turning the radio on, to enter the alignment mode.
- Rotate the (VFO-A)[SELECT] knob to select the alignment parameter "26-03 TCAR CLA."
- Press the PTT switch and rotate the (VFO-B)[SELECT] knob for maximum deflection on the ALC meter.
- Press the [ENT] key, and then release the PTT switch.
- Press and hold in the [MENU] button for 2 seconds to save the new setting and exit from the alignment mode.

REV-ALC Adjustment

- Connect the 100-Ohm Dummy Load and Wattmeter to the "ANT 1" jack.
- Press and hold in the [1(1.8)], [2(3.5)], and [3(7)] keys, while turning the radio on, to enter the alignment mode.
- Rotate the (VFO-A)[SELECT] knob to select the alignment parameter "28-01 RAC1.8."
- Rotate the (VFO-B)[SELECT] knob so that the VFO-B frequency display shows "0."
- Press the PTT switch without microphone input, then rotate the (VFO-B)[SELECT] knob for 160 W (± 10 W) on the Wattmeter.
- Release the PTT switch.
- Perform the same procedures for the Alignment Menus "d40 rAC" through "d49 rAC."
- Press and hold in the [MENU] button for 2 seconds to save the new setting and exit from the alignment mode.

ALIGNMENT MENU	ALIGNMENT MENU	MODE	WATTMETER
28-01 RAC1.8	1.820 MHz	CW-U	160 W ± 10 W
28-02 RAC3.5	3.570 MHz	CW-U	160 W ± 5 W
28-03 RAC7	7.050 MHz	CW-U	160 W ± 5 W
28-04 RAC10	10.100 MHz	CW-U	160 W ± 5 W
28-05 RAC14	14.200 MHz	CW-U	160 W ± 5 W
28-06 RAC18	18.100 MHz	CW-U	160 W ± 5 W
28-07 RAC21	21.200 MHz	CW-U	160 W ± 5 W
28-08 RAC24	24.900 MHz	CW-U	160 W ± 5 W
28-09 RAC28	29.690 MHz	CW-U	160 W ± 5 W
28-10 RAC50	53.900 MHz	CW-U	160 W ± 5 W

FM MAX Deviation Adjustment

- ❑ Connect the Dummy Load, Wattmeter, and Deviation Meter to the "ANT 1" Jack.
- ❑ Set the Main Band (VFO-A) frequency to 28.700 MHz in the FM mode.
- ❑ Connect the Audio Generator to pin 8 of the MIC jack (pin 7: GND), then set the output level to 10 mV @1 kHz.
- ❑ Press and hold in the [1(1.8)], [2(3.5)], and [3(7)] keys, while turning the radio on, to enter the alignment mode.
- ❑ Rotate the (VFO-A)[SELECT] knob to select the alignment parameter "29-02 FM DEV."
- ❑ Press the PTT switch and rotate the (VFO-B)[SELECT] knob for 4.5 kHz (± 0.2 kHz) on the Deviation Meter.
- ❑ Release the PTT switch.
- ❑ Set the Main Band (VFO-A) operating mode to the FM-N mode.
- ❑ Rotate the (VFO-A)[SELECT] knob to select the alignment parameter "29-03 FM DEV N."
- ❑ Press the PTT switch and rotate the (VFO-B)[SELECT] knob for 2.25 kHz (± 0.15 kHz) on the Deviation Meter.
- ❑ Release the PTT switch.
- ❑ Press and hold in the [MENU] button for 2 seconds to save the new setting and exit from the alignment mode.

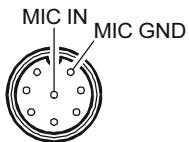

Meter Adjustment

IDD Meter Adjustment

- ❑ Connect the 50-Ohm Dummy Load and Wattmeter to the "ANT 1" Jack, then set the METER switch to the "ID" position.
- ❑ Connect the DC ammeter between J0006 (pin 2) and Pin 2 Connector on the PS Unit.
- ❑ Set the Main Band (VFO-A) frequency to 18.100 MHz in the CW mode, then set the [RF PWR] knob to the fully clockwise position.
- ❑ Press and hold in the [1(1.8)], [2(3.5)], and [3(7)] keys, while turning the radio on, to enter the alignment mode.
- ❑ Rotate the (VFO-A)[SELECT] knob to select the alignment parameter "31-01 IDD."
- ❑ Press the PTT switch and rotate the (VFO-B)[SELECT] knob so that the ID meter reading is same as that on the DC ammeter.
- ❑ Press the [ENT] key, and then release the PTT switch.
- ❑ Press and hold in the [MENU] button for 2 seconds to save the new setting and exit from the alignment mode.

COMP Meter Adjustment

- ❑ Press and hold in the [1(1.8)], [2(3.5)], and [3(7)] keys, while turning the radio on, to enter the alignment mode.
- ❑ Rotate the (VFO-A)[SELECT] knob to select the alignment parameter "31-02 COMP10," then rotate the (VFO-B)[SELECT] knob for "10 dB" on the COMP meter.
- ❑ Rotate the Main Tuning Dial knob to select the alignment parameter "31-03 COMP20," then rotate the (VFO-B)[SELECT] knob for "20 dB" on the COMP meter.
- ❑ Rotate the Main Tuning Dial knob to select the alignment parameter "31-04 COMP30," then rotate the (VFO-B)[SELECT] knob so that the COMP meter deflects to full scale.
- ❑ Press and hold in the [MNU] key for 2 seconds to exit from the alignment mode.

Alignment

SWR Meter Adjustment

- Switch the external display to the “SWR Monitor” screen.
- Connect the DMU-2000, then set the [METER] switch to the “SWR” position.
- Connect the 50-Ohm Dummy Load and Wattmeter to the “ANT 1” Jack, then set the [METER] switch to the “SWR” position.
- Disconnect the 3-pin plug from J1020 on the MAIN Unit, then apply a 4.2 V DC voltage to pin 2 of J1020, and 2.1 V DC to pin 3 of J1020.
- Press and hold in the [1(1.8)], [2(3.5)], and [3(7)] keys, while turning the radio on, to enter the alignment mode.
- Rotate the (VFO-A)[SELECT] knob to select the alignment parameter “30-04 REV-CO.”
- Press the PTT switch and rotate the (VFO-B)[SELECT] knob so that the SWR meter (on the external display) reading is “3.0.” (The SWR meter reading may be a few points broad).
- Release the PTT switch.
- Rotate the (VFO-A)[SELECT] knob to select the alignment parameter “30-03 SWR3.0.”
- Rotate the [SUB(VFO-B)] knob so that the SWR meter (on the front panel) reading is “3.0.”
- Release the PTT switch.
- Apply a 4.2 V DC voltage to pin 2 of J1020, and 1.4 V DC to pin 3 of J1020.
- Rotate the (VFO-A)[SELECT] knob to select the alignment parameter “30-02 SWR2.0.”
- Press the PTT switch and rotate the (VFO-B)[SELECT] knob so that the SWR meter (on the front panel) reading is “2.0.”
- Release the PTT switch.
- Apply a 4.2 V DC voltage to pin 2 of J1020, and 0.84 V DC to pin 3 of J1020.
- Rotate the (VFO-A)[SELECT] knob to select the alignment parameter “30-01 SWR1.5.”
- Press the PTT switch and rotate the (VFO-B)[SELECT] knob so that the SWR meter (on the front panel) reading is “1.5.”
- Release the PTT switch.
- Perform the same procedures for the Alignment Menus “30-05 SWR1.5” and “30-12 REV-CO.”
- Press and hold in the [MENU] button for 2 seconds to save the new setting and exit from the alignment mode.

FREQUENCY	ALIGNMENT MENU	SWR	J1020	
			VF	VR
1.820 MHz	30-04 REV-CO	3.0	4.2 V	2.1 V
	30-03 SWR3.0	3.0	4.2 V	2.1 V
	30-02 SWR2.0	2.0	4.2 V	1.4 V
	30-01 SWR1.5	1.5	4.2 V	0.84 V
14.200MHz	30-08 REV-CO	3.0	4.2 V	2.1 V
	30-07 SWR3.0	3.0	4.2 V	2.1 V
	30-06 SWR2.0	2.0	4.2 V	1.4 V
	30-05 SWR1.5	1.5	4.2 V	0.84 V
50.200MHz	30-12 REV-CO	3.0	4.2 V	2.1 V
	30-11 SWR3.0	3.0	4.2 V	2.1 V
	30-10 SWR2.0	2.0	4.2 V	1.4 V
	30-09 SWR1.5	1.5	4.2 V	0.84 V

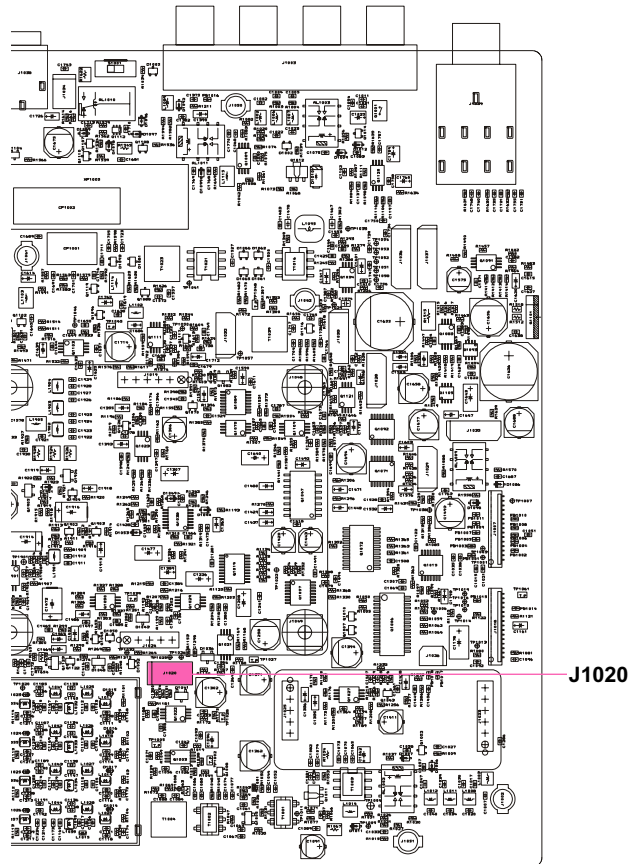

TRX UNIT ALIGNMENT POINTS

SCP Unit Adjustment

SC-L02 Adjustment

- ❑ Connect the RF millivoltmeter to TP2703 on the SCP Unit.
- ❑ Adjust T2701 on the SCP Unit for maximum deflection on the RF millivoltmeter (more than 4.5 Vems).

SC-RXIF Adjustment

- ❑ Connect the DC voltmeter to TP2702 on the SCP Unit.
- ❑ Set the RF Signal Generator output to +36 dB μ at 14.200 MHz.
- ❑ Press and hold in the [1(1.8)], [2(3.5)], and [3(7)] keys, while turning the radio on, to enter the alignment mode.
- ❑ Rotate the (VFO-A)[SELECT] knob to select the alignment parameter "32-01 SCP."
- ❑ Adjust T2707 and T2704 on the SCP Unit for maximum deflection on the RF millivoltmeter (more than 4.5 Vems).

SC-Output Adjustment

- ❑ Connect the Digital DC voltmeter (high-Z) to TP2701 on the SCP Unit.
- ❑ Set the RF Signal Generator output to +80 dB μ at 14.200 MHz.
- ❑ Press and hold in the [1(1.8)], [2(3.5)], and [3(7)] keys, while turning the radio on, to enter the alignment mode.
- ❑ Rotate the (VFO-A)[SELECT] knob to select the alignment parameter "32-01 SCP."
- ❑ Adjust VR2701 on the SCP Unit for 3.10 \pm 0.02V on the Digital DC voltmeter.

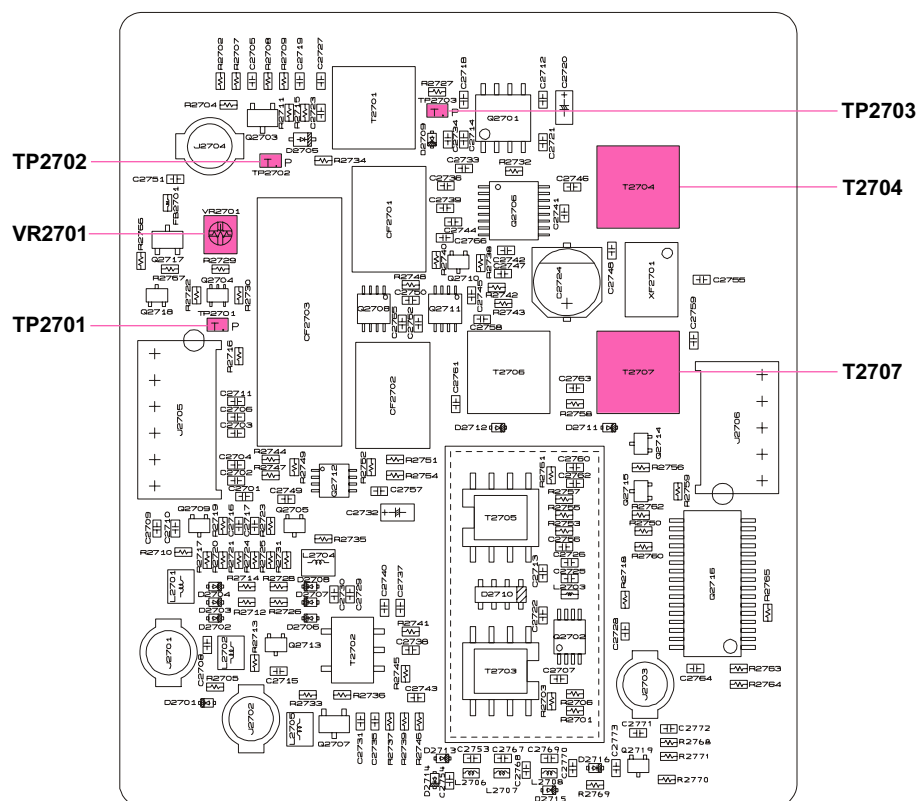

SCP UNIT ALIGNMENT POINTS

Alignment

SC-TXIF Adjustment

- Connect the 50-Ohm Dummy Load and Wattmeter to the “ANT 1” jack.
- Set the Main Band (VFO-A) frequency to 14.200 MHz in the CW mode.
- Rotate the [RF PWR] knob fully counterclockwise.
- Connect the DC voltmeter to TP2702 on the SCP Unit.
- Press and hold in the [1(1.8)], [2(3.5)], and [3(7)] keys, while turning the radio on, to enter the alignment mode.
- Rotate the (VFO-A)[SELECT] knob to select the alignment parameter “32-01 SCP.”
- Press the PTT switch and adjust T2706 on the SCP Unit for maximum deflection on the DC voltmeter (more than 1.5 V).
- Release the PTT switch.

SC-Output (2) Adjustment

- Connect the DMU-2000 to the FT_{Dx}5000.
- Connect the Digital DC voltmeter (high-Z) to TP1061 on the TRX Unit.
- Set the RF Signal Generator output to +80 dB μ at 14.200 MHz.
- Press and hold in the [1(1.8)], [2(3.5)], and [3(7)] keys, while turning the radio on, to enter the alignment mode.
- Rotate the (VFO-A)[SELECT] knob to select the alignment parameter “32-01 SCP.”
- Adjust VR2701 on the SCP Unit for $3.10 \pm 0.02V$ on the Digital DC voltmeter.

TRX Unit (Lot. 1 ~ 3)

Circuit Diagram (2)

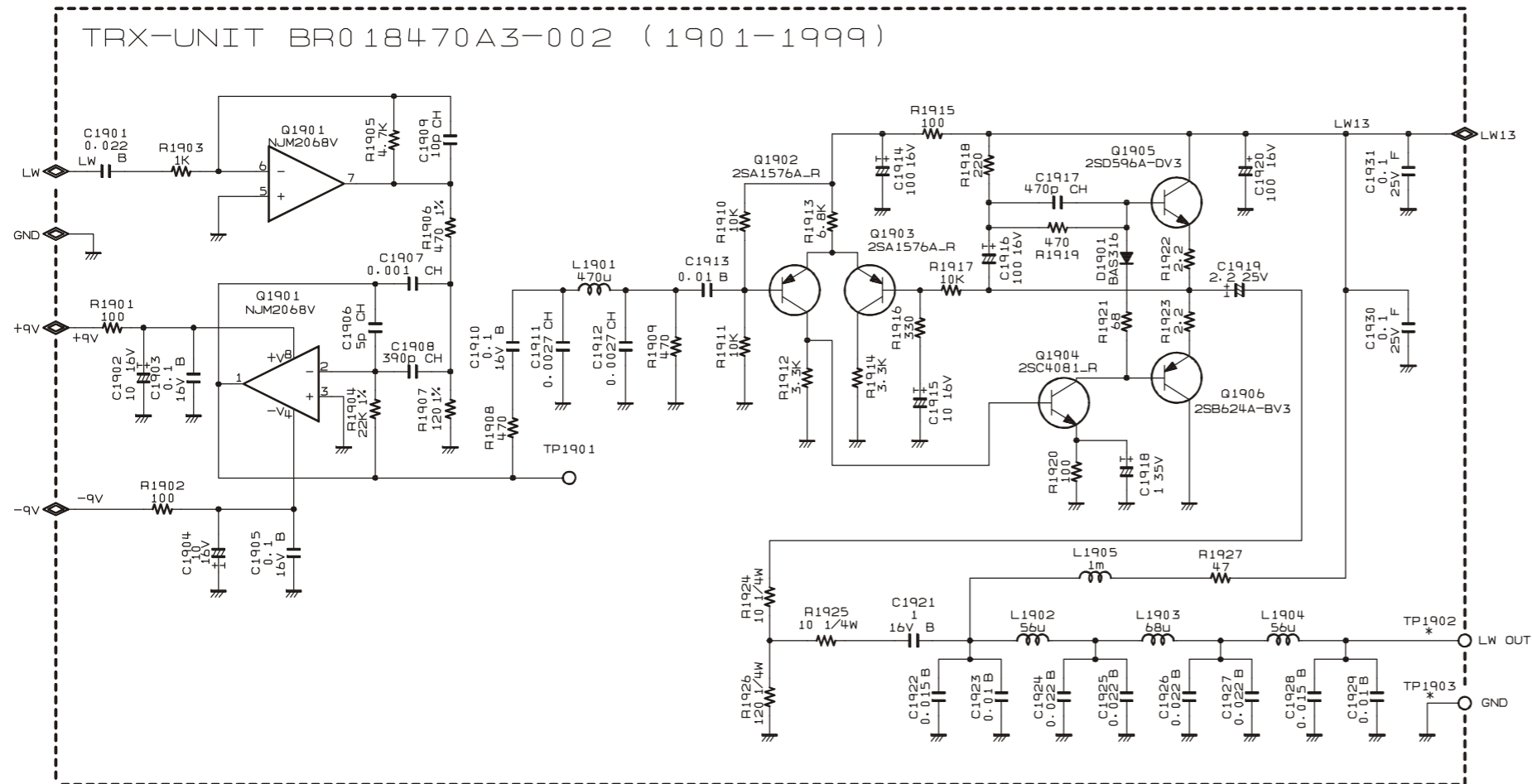

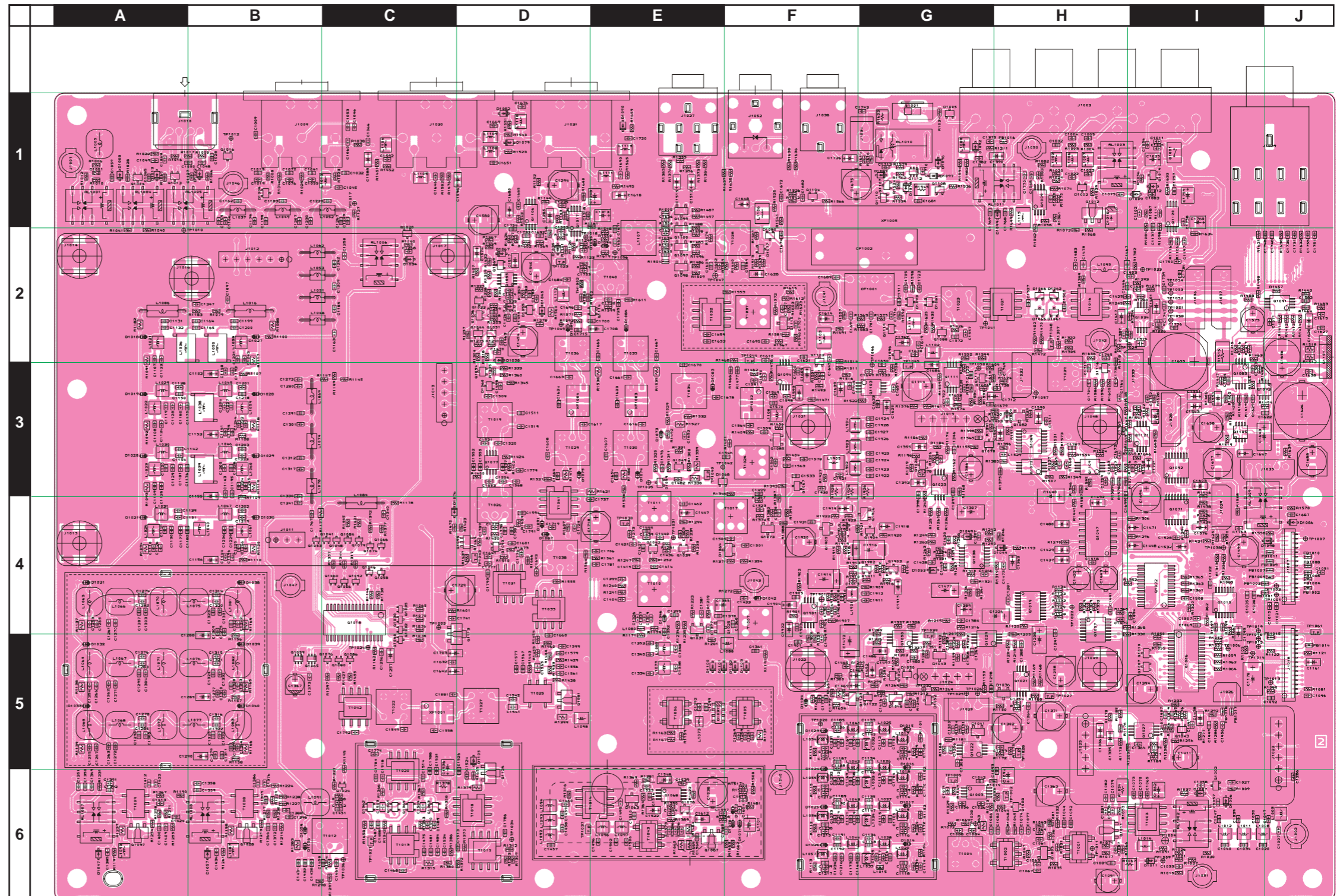

TRX Unit (Lot. 1 ~ 3)

Parts Layout (Side B)

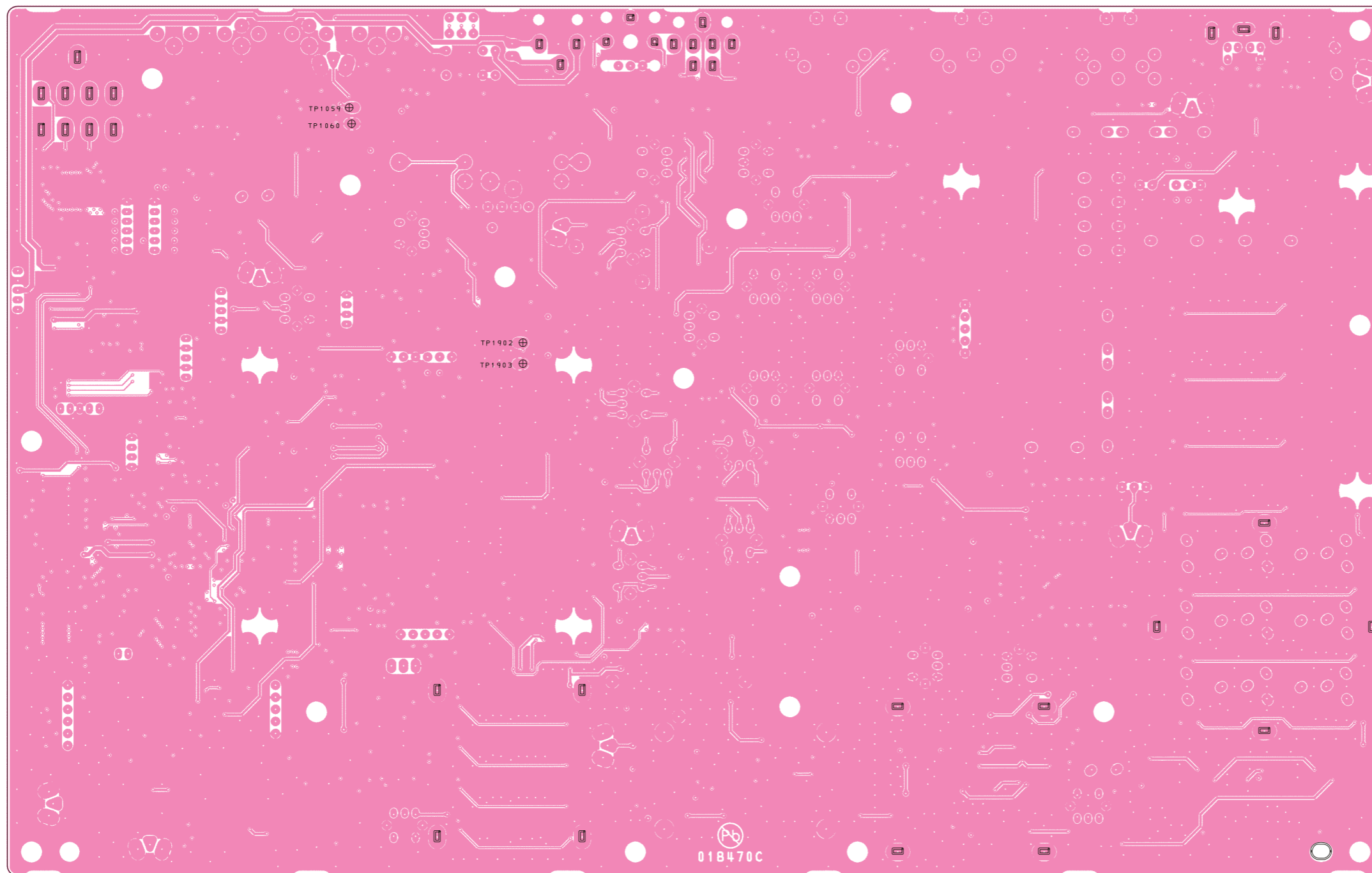

TRX Unit (Lot. 4 ~ 7)

Circuit Diagram (2)

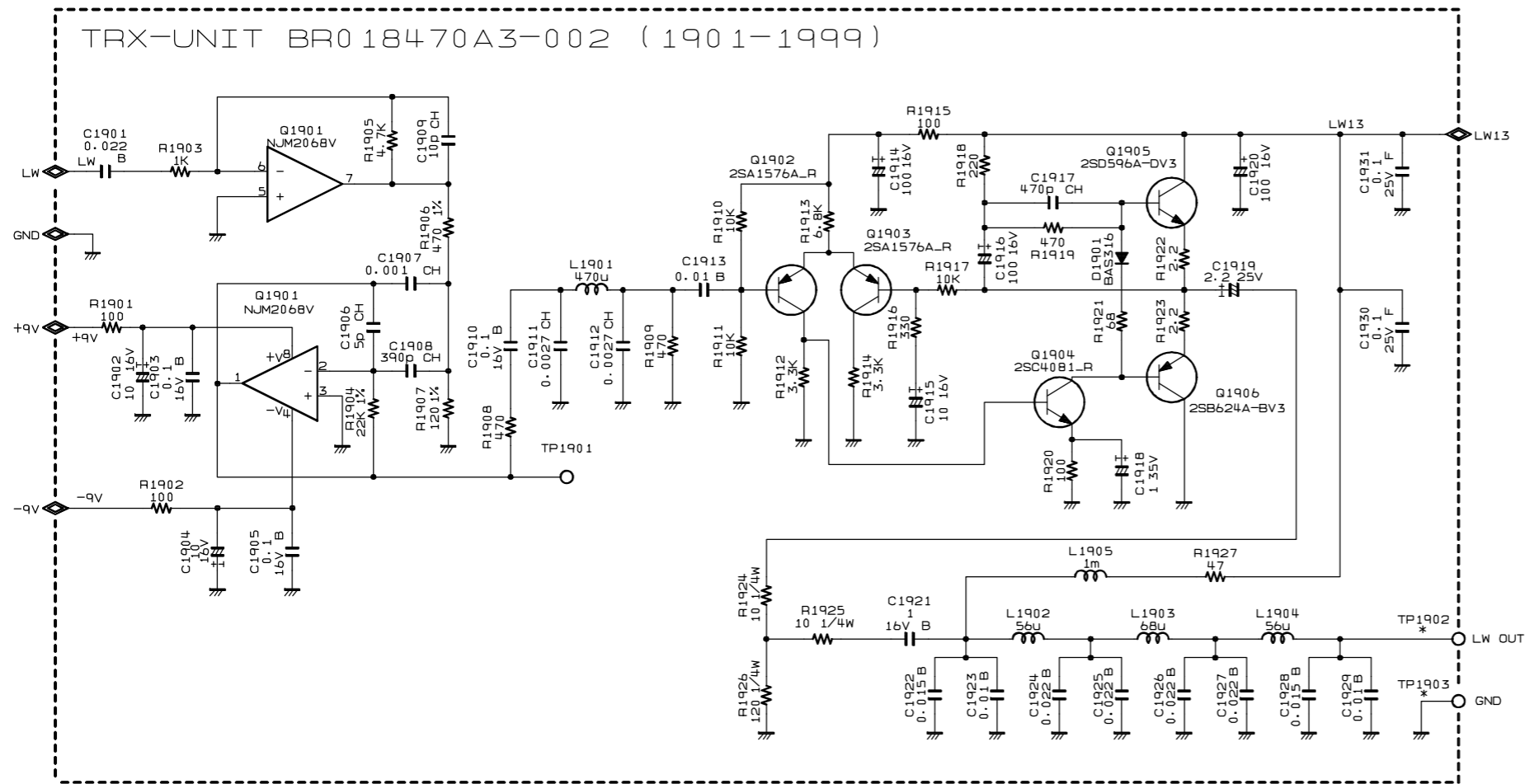

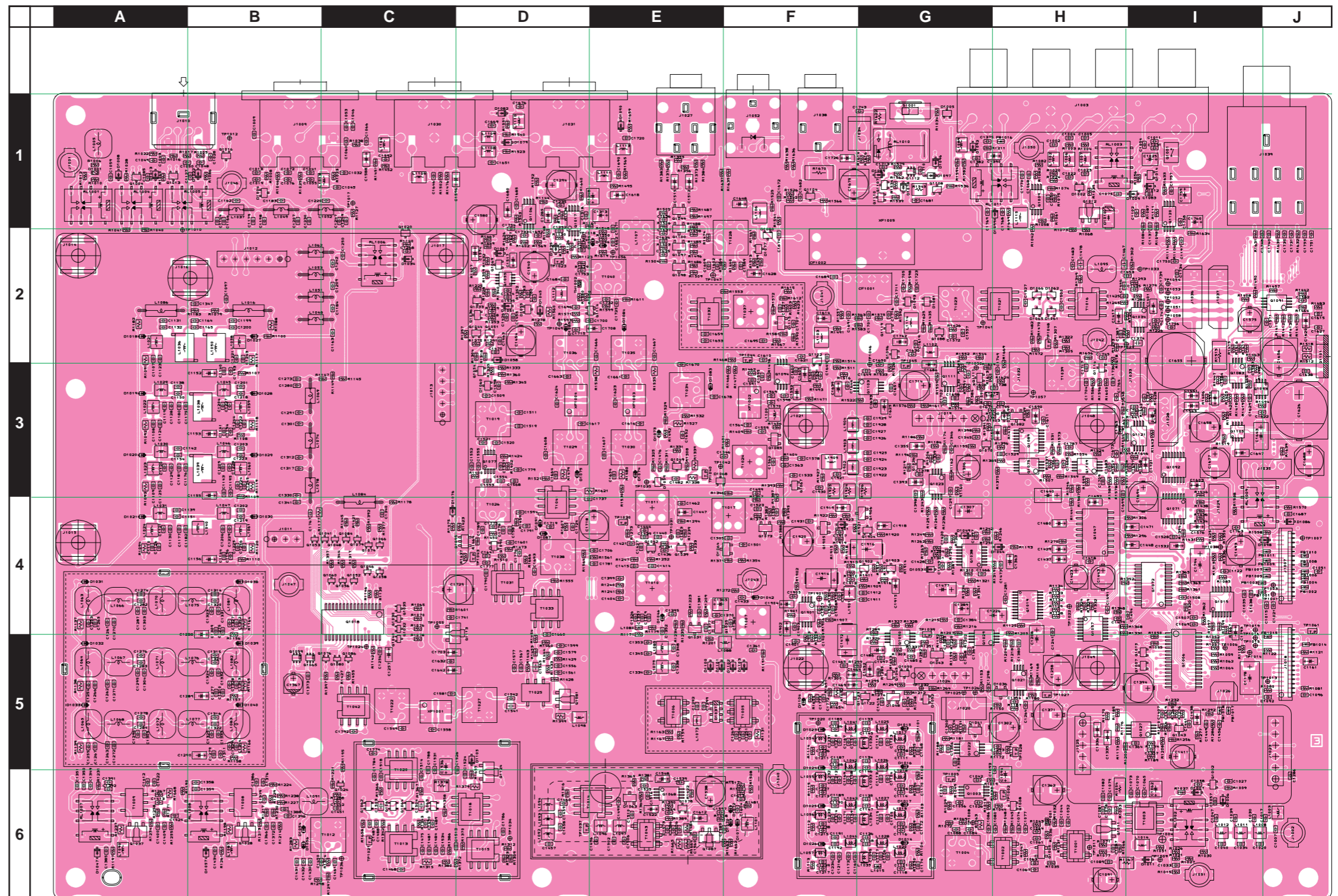

TRX Unit (Lot. 4 ~ 7)

Parts Layout (Side B)

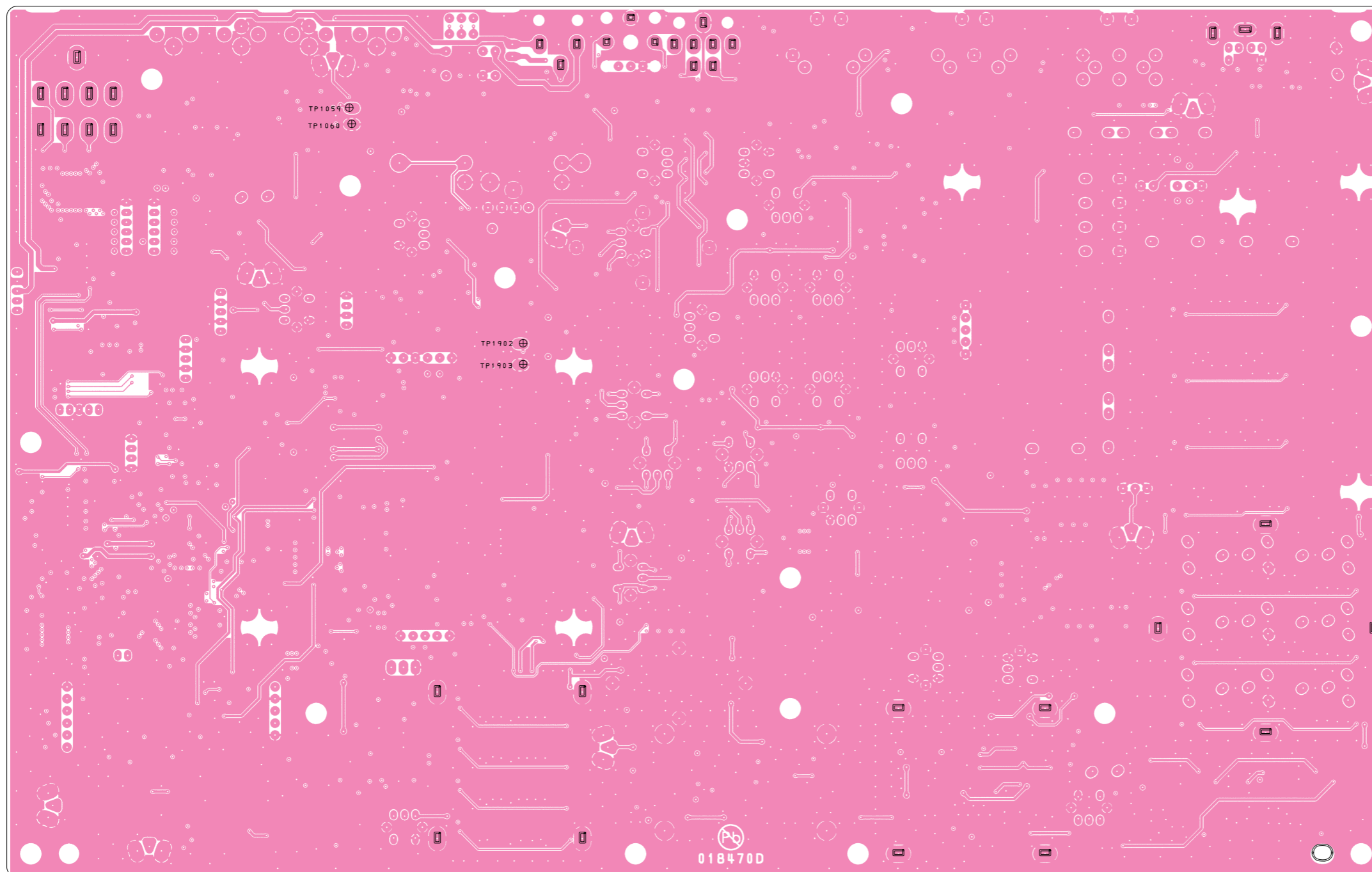

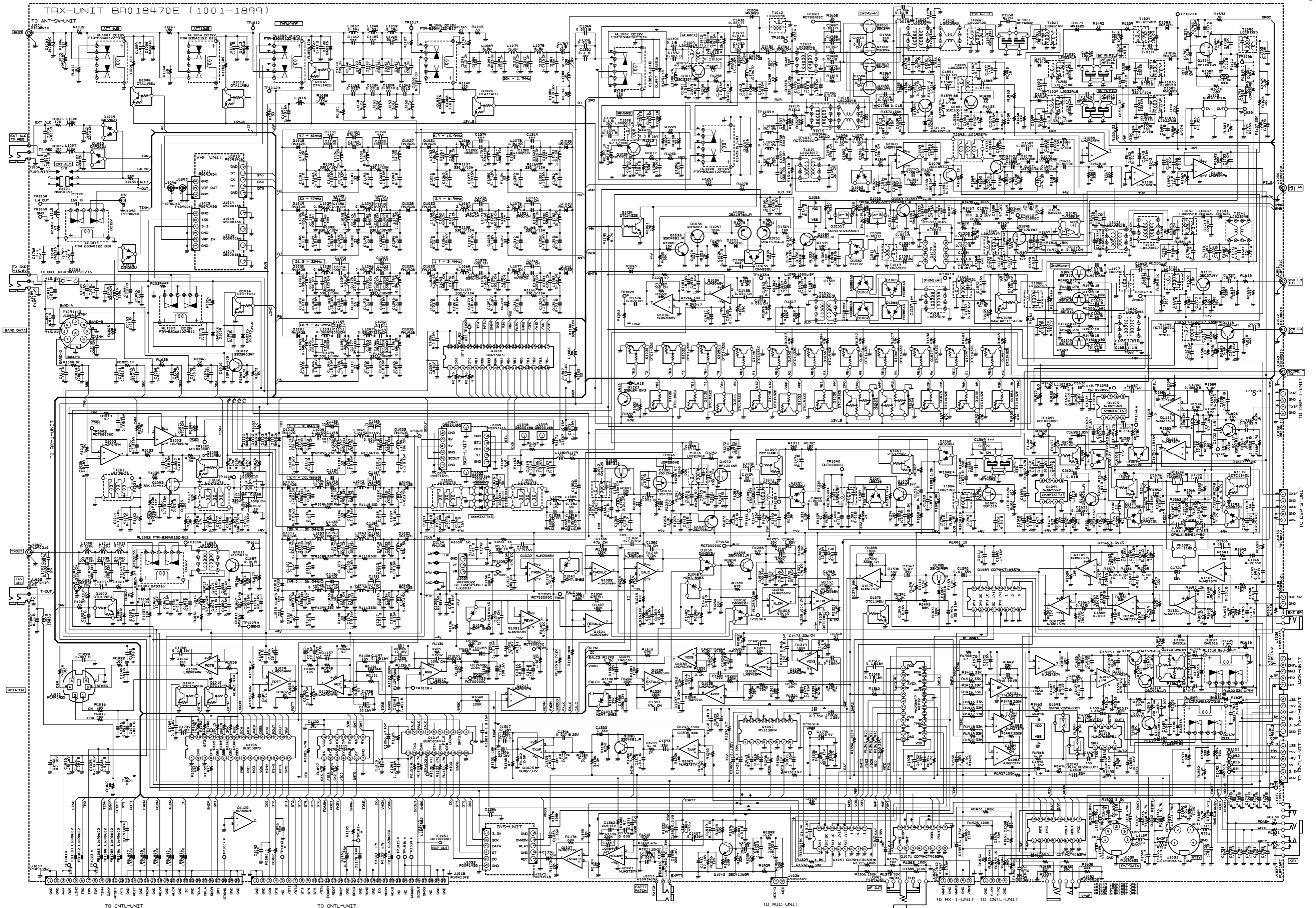

TRX Unit (Lot. 8 ~)

Circuit Diagram (2)

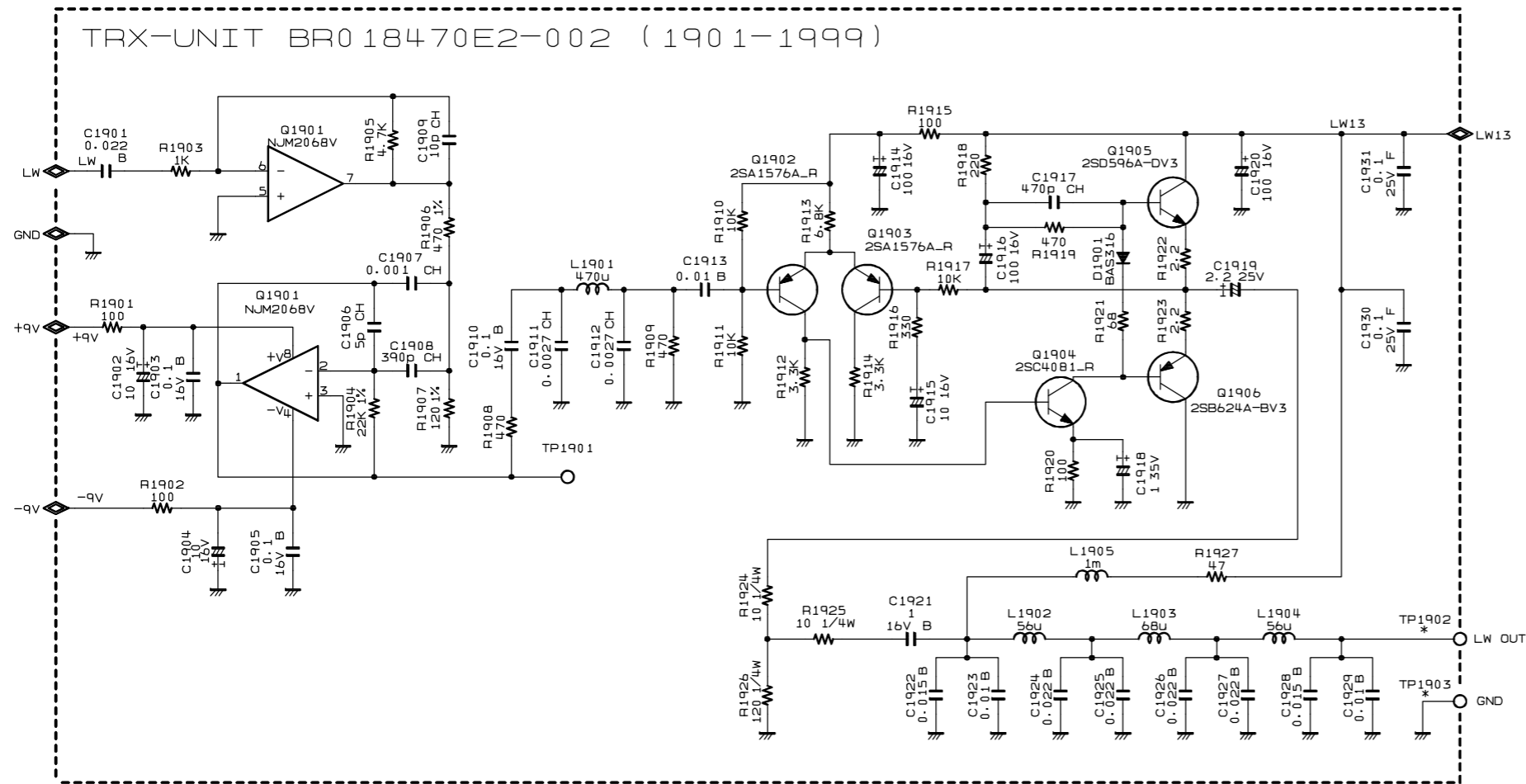

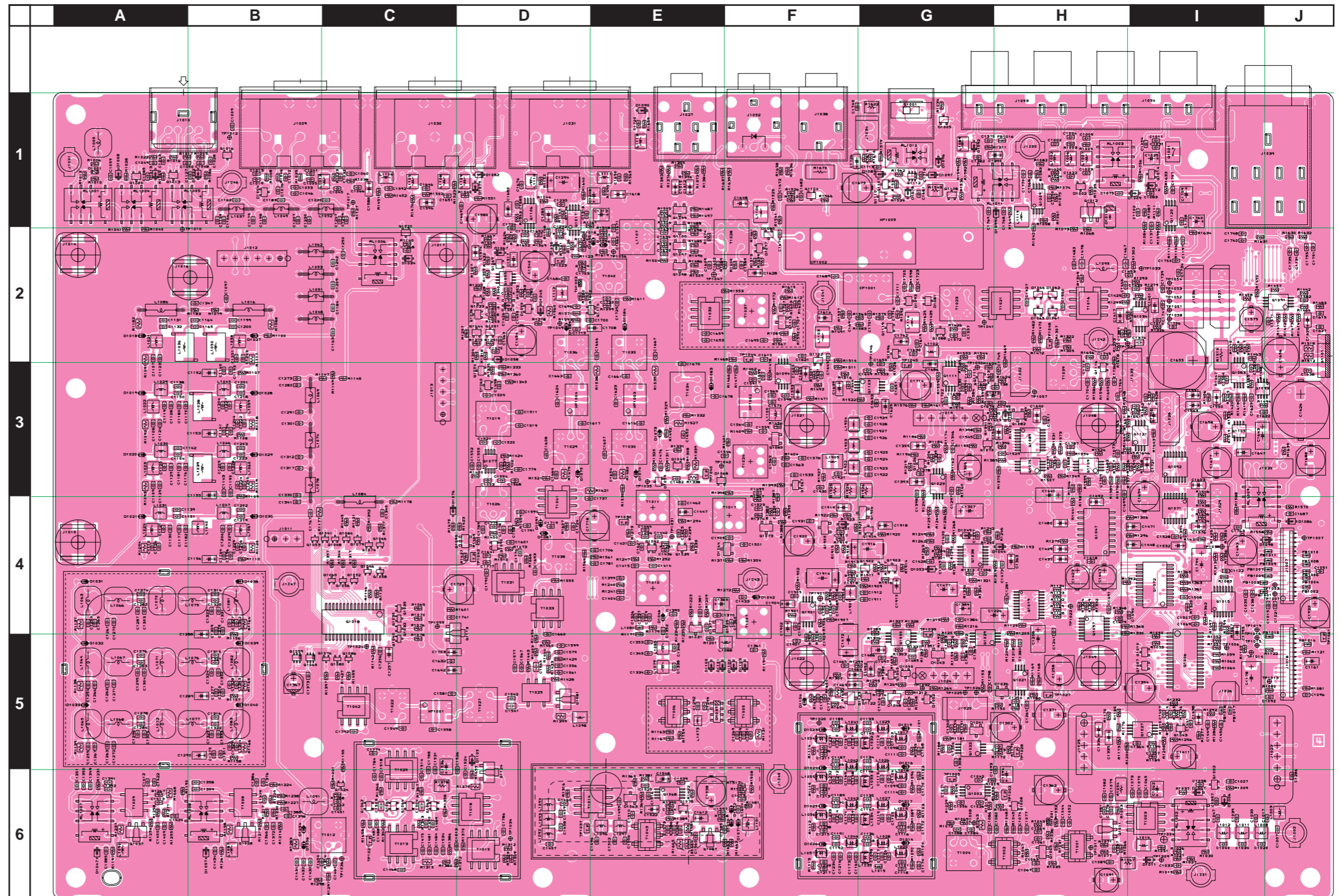

TRX Unit (Lot. 8 ~)

Parts Layout (Side B)

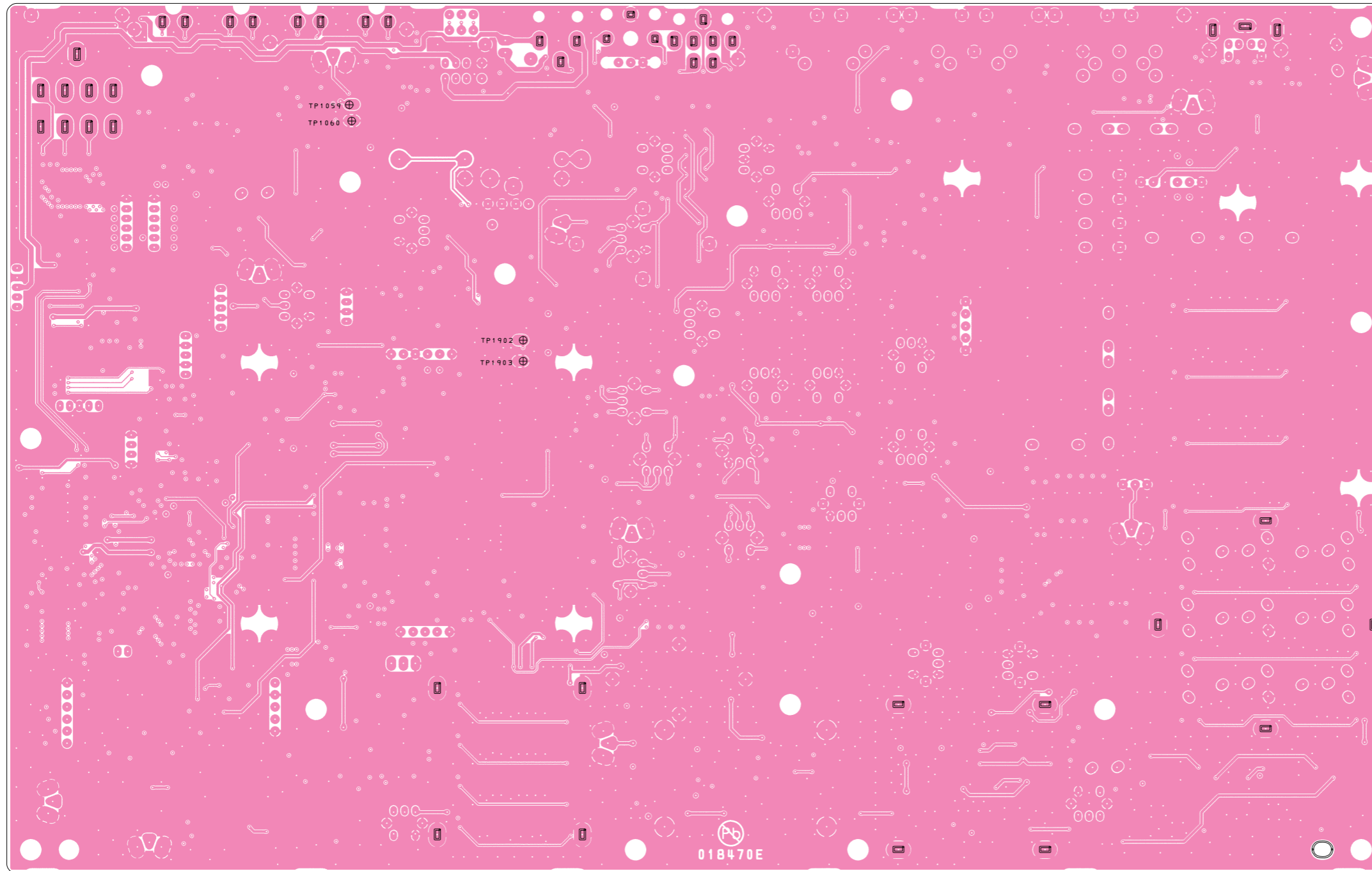

REF	DESCRIPTION	VALUE	V/W	TOL.	MFR'S DESIG	VXSTD P/N	VERS.	LOT	SIDE	LAY ADR
	PCB with Components					CS2071701	USA			
	PCB with Components					CS2071703	EXPORT			
	PCB with Components					CS2071704	EUROPE			
	PCB with Components					CS2071705	UNITED KINGDOM			
	PCB with Components					CS2071706	FRANCE			
	PCB with Components					CS2071707	AUSTRALIA			
	Printed Circuit Board					FR018470C		1-	A	H1
	Printed Circuit Board					FR018470D		4-5		
	Printed Circuit Board					FR018470D	W/O CE LABEL	6-10		
	Printed Circuit Board					FR018470E	W/CE LABEL	8-10		
	Printed Circuit Board					FR018470E		11-		
C 1002	CHIP CAP.	0.01uF	50V	B	GRM188B11H103KA01D	K22174823		1-	A	H1
C 1004	CHIP CAP.	0.001uF	50V	B	GRM188B11H102KA01D	K22174821		1-	A	H1
C 1005	CHIP CAP.	0.001uF	50V	B	GRM188B11H102KA01D	K22174821		1-	A	H1
C 1007	CHIP CAP.	22pF	50V	CH	GRM1882C1H220JA01D	K22174219		1-	A	J6
C 1009	CHIP CAP.	0.01uF	50V	B	GRM188B11H103KA01D	K22174823		1-	A	B1
C 1011	CHIP CAP.	0.01uF	50V	B	GRM188B11H103KA01D	K22174823		1-	A	I1
C 1013	CHIP CAP.	0.001uF	50V	B	GRM188B11H102KA01D	K22174821		1-	A	B1
C 1015	CHIP CAP.	0.1uF	16V	B	GRM188B11C104KA01D	K22124805		1-	A	J4
C 1017	CHIP CAP.	27pF	50V	CH	GRM1882C1H270JA01D	K22174221		1-	A	J6
C 1019	CHIP CAP.	100pF	50V	CH	GRM1882C1H101JA01D	K22174235		1-	A	B1
C 1020	CHIP CAP.	27pF	50V	CH	GRM1882C1H270JA01D	K22174221		1-	A	I6
C 1021	CHIP CAP.	0.001uF	50V	B	GRM188B11H102KA01D	K22174821		1-	A	J4
C 1022	CHIP CAP.	220pF	50V	CH	GRM1882C1H221JA01D	K22174243		1-	A	H1
C 1023	CHIP CAP.	220pF	50V	CH	GRM1882C1H221JA01D	K22174243		1-	A	H1
C 1025	CHIP TA.CAP.	10uF	16V		TEESVB21C106M8R	K78120025		1-	A	I1
C 1026	CHIP CAP.	0.1uF	16V	B	GRM188B11C104KA01D	K22124805		1-	A	G6
C 1027	CHIP CAP.	0.01uF	50V	B	GRM188B11H103KA01D	K22174823		1-	A	I6
C 1028	CHIP CAP.	0.001uF	50V	B	GRM188B11H102KA01D	K22174821		1-	A	B1
C 1030	CHIP CAP.	68pF	50V	CH	GRM1882C1H680JA01D	K22174231		1-	A	I6
C 1031	CHIP CAP.	0.01uF	50V	B	GRM188B11H103KA01D	K22174823		1-	A	I1
C 1032	CHIP CAP.	220pF	50V	CH	GRM1882C1H221JA01D	K22174243		1-	A	C1
C 1033	CHIP CAP.	0.01uF	50V	B	GRM188B11H103KA01D	K22174823		1-	A	I6
C 1034	CHIP CAP.	22pF	50V	CH	GRM1882C1H220JA01D	K22174219		1-	A	I6
C 1035	CHIP CAP.	0.1uF	16V	B	GRM188B11C104KA01D	K22124805		1-	A	I4
C 1038	CHIP CAP.	0.001uF	50V	B	GRM188B11H102KA01D	K22174821		1-	A	I4
C 1039	CHIP CAP.	82pF	50V	CH	GRM1882C1H820JA01D	K22174233		1-	A	I6
C 1040	CHIP CAP.	6pF	50V	CH	GRM1882C1H6R0DZ01D	K22174207		1-	A	I6
C 1041	CHIP CAP.	0.001uF	50V	B	GRM188B11H102KA01D	K22174821		1-	A	B1
C 1042	CHIP CAP.	0.1uF	16V	B	GRM188B11C104KA01D	K22124805		1-	A	G6
C 1043	CHIP CAP.	0.001uF	50V	B	GRM188B11H102KA01D	K22174821		1-	A	A1
C 1044	CHIP CAP.	0.1uF	16V	B	GRM188B11C104KA01D	K22124805		1-	A	H6
C 1045	CHIP CAP.	220pF	50V	CH	GRM1882C1H221JA01D	K22174243		1-	A	B1
C 1046	CHIP CAP.	0.01uF	50V	B	GRM188B11H103KA01D	K22174823		1-	A	C1
C 1047	CHIP CAP.	47pF	50V	CH	GRM1882C1H470JA01D	K22174227		1-	A	I6
C 1048	CHIP CAP.	0.001uF	50V	B	GRM188B11H102KA01D	K22174821		1-	A	B1
C 1049	CHIP CAP.	0.001uF	50V	B	GRM188B11H102KA01D	K22174821		1-	A	A1
C 1050	CHIP CAP.	0.001uF	50V	B	GRM188B11H102KA01D	K22174821		1-	A	A1
C 1052	CHIP CAP.	0.01uF	50V	B	GRM188B11H103KA01D	K22174823		1-	A	H6
C 1053	CHIP CAP.	0.01uF	50V	B	GRM188B11H103KA01D	K22174823		1-	A	B1
C 1054	CHIP CAP.	0.001uF	50V	B	GRM188B11H102KA01D	K22174821		1-	A	I1
C 1055	CHIP CAP.	100pF	50V	CH	GRM1882C1H101JA01D	K22174235		1-	A	B1
C 1056	CHIP CAP.	0.1uF	16V	B	GRM188B11C104KA01D	K22124805		1-	A	G6
C 1057	CHIP CAP.	0.01uF	50V	B	GRM188B11H103KA01D	K22174823		1-	A	I6
C 1058	CHIP CAP.	0.01uF	50V	B	GRM188B11H103KA01D	K22174823		1-	A	I6
C 1059	CHIP CAP.	0.01uF	50V	B	GRM188B11H103KA01D	K22174823		1-	A	A1
C 1060	CHIP CAP.	0.001uF	50V	B	GRM188B11H102KA01D	K22174821		1-	A	C1
C 1061	CHIP CAP.	0.1uF	16V	B	GRM188B11C104KA01D	K22124805		1-	A	H6
C 1062	CHIP TA.CAP.	10uF	16V		TEESVB21C106M8R	K78120025		1-	A	I6
C 1063	CHIP CAP.	0.1uF	16V	B	GRM188B11C104KA01D	K22124805		1-	A	H6
C 1064	CHIP CAP.	0.01uF	50V	B	GRM188B11H103KA01D	K22174823		1-	A	H6
C 1065	CHIP CAP.	0.1uF	16V	B	GRM188B11C104KA01D	K22124805		1-	A	I6
C 1066	CHIP CAP.	100pF	50V	CH	GRM1882C1H101JA01D	K22174235		1-	A	C1
C 1067	CHIP CAP.	0.01uF	50V	B	GRM188B11H103KA01D	K22174823		1-	A	H6
C 1068	CHIP CAP.	0.1uF	16V	B	GRM188B11C104KA01D	K22124805		1-	A	H1
C 1069	CHIP CAP.	0.1uF	16V	B	GRM188B11C104KA01D	K22124805		1-	A	I4
C 1070	CHIP CAP.	0.01uF	50V	B	GRM188B11H103KA01D	K22174823		1-	A	I6
C 1071	CHIP CAP.	470pF	50V	CH	GRM1882C1H471JA01D	K22174249		1-	A	G6
C 1072	CHIP CAP.	0.001uF	50V	B	GRM188B11H102KA01D	K22174821		1-	A	B1
C 1073	CHIP CAP.	0.001uF	50V	B	GRM188B11H102KA01D	K22174821		1-	A	I6
C 1074	CHIP CAP.	0.1uF	16V	B	GRM188B11C104KA01D	K22124805		1-	A	H6
C 1075	CHIP CAP.	0.01uF	50V	B	GRM188B11H103KA01D	K22174823		1-	A	H1
C 1076	CHIP CAP.	100pF	50V	CH	GRM1882C1H101JA01D	K22174235		1-	A	B1

TRX Unit

Parts List

REF	DESCRIPTION	VALUE	V/W	TOL.	MFR'S DESIG	VXSTD P/N	VERS.	LOT	SIDE	LAY ADR
C 1077	CHIP CAP.	0.01uF	50V	B	GRM188B11H103KA01D	K22174823		1-	A	H6
C 1078	CHIP CAP.	270pF	50V	CH	GRM1882C1H271JA01D	K22174251		1-	A	H6
C 1079	CHIP CAP.	0.01uF	50V	B	GRM188B11H103KA01D	K22174823		1-	A	H6
C 1080	CHIP CAP.	0.01uF	50V	B	GRM188B11H103KA01D	K22174823		1-	A	H6
C 1081	CHIP CAP.	270pF	50V	CH	GRM1882C1H271JA01D	K22174251		1-	A	H6
C 1082	CHIP CAP.	0.1uF	16V	B	GRM188B11C104KA01D	K22124805		1-	A	H6
C 1083	CHIP CAP.	0.01uF	50V	B	GRM188B11H103KA01D	K22174823		1-	A	I1
C 1084	CHIP CAP.	330pF	50V	CH	GRM1882C1H331JA01D	K22174253		1-	A	G6
C 1085	CHIP CAP.	0.01uF	50V	B	GRM188B11H103KA01D	K22174823		1-	A	A1
C 1086	CHIP CAP.	0.1uF	16V	B	GRM188B11C104KA01D	K22124805		1-	A	G6
C 1087	CHIP CAP.	0.01uF	50V	B	GRM188B11H103KA01D	K22174823		1-	A	H6
C 1088	CHIP CAP.	330pF	50V	CH	GRM1882C1H331JA01D	K22174253		1-	A	G6
C 1089	CHIP CAP.	0.1uF	16V	B	GRM188B11C104KA01D	K22124805		1-	A	H6
C 1090	CHIP CAP.	0.01uF	50V	B	GRM188B11H103KA01D	K22174823		1-	A	H1
C 1091	AL.ELECTRO.CAP.	22uF	16V		EEE1CA220SR	K48120024		1-	A	H6
C 1093	CHIP CAP.	0.01uF	50V	B	GRM188B11H103KA01D	K22174823		1-	A	G6
C 1094	CHIP TA.CAP.	10uF	16V		TEESVB21C106M8R	K78120025		1-	A	H6
C 1097	CHIP CAP.	0.1uF	16V	B	GRM188B11C104KA01D	K22124805		1-	A	B2
C 1098	CHIP CAP.	0.1uF	16V	B	GRM188B11C104KA01D	K22124805		1-	A	G5
C 1099	CHIP CAP.	0.1uF	16V	B	GRM188B11C104KA01D	K22124805		1-	A	G6
C 1100	CHIP CAP.	0.1uF	16V	B	GRM188B11C104KA01D	K22124805		1-	A	G6
C 1101	CHIP CAP.	0.1uF	16V	B	GRM188B11C104KA01D	K22124805		1-	A	G6
C 1102	CHIP CAP.	0.1uF	16V	B	GRM188B11C104KA01D	K22124805		1-	A	I1
C 1103	CHIP CAP.	180pF	50V	CH	GRM1882C1H181JA01D	K22174241		1-	A	G5
C 1104	CHIP CAP.	150pF	50V	CH	GRM1882C1H151JA01D	K22174239		1-	A	G6
C 1105	CHIP CAP.	120pF	50V	CH	GRM1882C1H121JA01D	K22174237		1-	A	G6
C 1106	CHIP CAP.	180pF	50V	CH	GRM1882C1H181JA01D	K22174241		1-	A	G6
C 1107	CHIP CAP.	0.01uF	50V	B	GRM188B11H103KA01D	K22174823		1-	A	A2
C 1108	CHIP CAP.	0.01uF	50V	B	GRM188B11H103KA01D	K22174823		1-	A	A3
C 1109	CHIP CAP.	0.01uF	50V	B	GRM188B11H103KA01D	K22174823		1-	A	A3
C 1110	CHIP CAP.	0.01uF	50V	B	GRM188B11H103KA01D	K22174823		1-	A	A4
C 1111	CHIP CAP.	0.01uF	50V	B	GRM188B11H103KA01D	K22174823		1-	A	G5
C 1112	CHIP CAP.	18pF	50V	CH	GRM1882C1H180JA01D	K22174217		1-	A	G5
C 1114	CHIP CAP.	0.01uF	50V	B	GRM188B11H103KA01D	K22174823		1-	A	G6
C 1115	CHIP CAP.	4pF	50V	CH	GRM1882C1H4R0CZ01D	K22174205		1-	A	G6
C 1116	CHIP CAP.	0.01uF	50V	B	GRM188B11H103KA01D	K22174823		1-	A	G6
C 1118	CHIP CAP.	0.01uF	50V	B	GRM188B11H103KA01D	K22174823		1-	A	G6
C 1119	CHIP CAP.	82pF	50V	CH	GRM1882C1H820JA01D	K22174233		1-	A	A3
C 1120	CHIP CAP.	68pF	50V	CH	GRM1882C1H680JA01D	K22174231		1-	A	A3
C 1121	CHIP CAP.	120pF	50V	CH	GRM1882C1H121JA01D	K22174237		1-	A	A4
C 1123	CHIP CAP.	0.1uF	16V	B	GRM188B11C104KA01D	K22124805		1-	A	A2
C 1124	CHIP CAP.	0.1uF	16V	B	GRM188B11C104KA01D	K22124805		1-	A	A3
C 1125	CHIP CAP.	0.1uF	16V	B	GRM188B11C104KA01D	K22124805		1-	A	A3
C 1126	CHIP CAP.	0.1uF	16V	B	GRM188B11C104KA01D	K22124805		1-	A	A4
C 1127	CHIP CAP.	0.01uF	50V	B	GRM188B11H103KA01D	K22174823		1-	A	B1
C 1129	CHIP CAP.	12pF	50V	CH	GRM1882C1H120JA01D	K22174213		1-	A	A3
C 1130	CHIP CAP.	10pF	50V	CH	GRM1882C1H100JA01D	K22174211		1-	A	A4
C 1132	CHIP CAP.	180pF	50V	CH	GRM1882C1H181JA01D	K22174241		1-	A	A2
C 1133	CHIP CAP.	150pF	50V	CH	GRM1882C1H151JA01D	K22174239		1-	A	G5
C 1134	CHIP CAP.	4pF	50V	CH	GRM1882C1H4R0CZ01D	K22174205		1-	A	G5
C 1135	CHIP CAP.	2pF	50V	CK	GRM1884C1H2R0CZ01D	K22174203		1-	A	G6
C 1136	CHIP CAP.	1pF	50V	CK	GRM1884C1H1R0CZ01D	K22174202		1-	A	G6
C 1138	CHIP CAP.	3pF	50V	CJ	GRM1883C1H3R0CZ01D	K22174204		1-	A	A3
C 1139	CHIP CAP.	8pF	50V	CH	GRM1882C1H8R0DZ01D	K22174209		1-	A	A4
C 1140	CHIP CAP.	0.1uF	16V	B	GRM188B11C104KA01D	K22124805		1-	A	B3
C 1141	CHIP CAP.	0.1uF	16V	B	GRM188B11C104KA01D	K22124805		1-	A	B3
C 1142	CHIP CAP.	4pF	50V	CH	GRM1882C1H4R0CZ01D	K22174205		1-	A	A3
C 1143	CHIP CAP.	0.1uF	16V	B	GRM188B11C104KA01D	K22124805		1-	A	B3
C 1144	CHIP CAP.	0.1uF	16V	B	GRM188B11C104KA01D	K22124805		1-	A	B4
C 1145	CHIP CAP.	0.0015uF	50V	CH	GRM1882C1H152JA01D	K22174277		1-	A	G5
C 1146	CHIP CAP.	120pF	50V	CH	GRM1882C1H121JA01D	K22174237		1-	A	G6
C 1147	CHIP CAP.	39pF	50V	CH	GRM1882C1H390JA01D	K22174225		1-	A	G6
C 1148	CHIP CAP.	12pF	50V	CH	GRM1882C1H120JA01D	K22174213		1-	A	G6
C 1149	CHIP CAP.	39pF	50V	CH	GRM1882C1H390JA01D	K22174225		1-	A	B1
C 1150	CHIP CAP.	27pF	50V	CH	GRM1882C1H270JA01D	K22174221		1-	A	A3
C 1151	CHIP CAP.	100pF	50V	CH	GRM1882C1H101JA01D	K22174235		1-	A	A4
C 1152	CHIP TA.CAP.	4.7uF	16V		TEESVA1C475M8R	K78120031		1-	A	B3
C 1153	CHIP TA.CAP.	4.7uF	16V		TEESVA1C475M8R	K78120031		1-	A	B3
C 1154	CHIP CAP.	56pF	50V	CH	GRM1882C1H560JA01D	K22174229		1-	A	A3
C 1155	CHIP TA.CAP.	4.7uF	16V		TEESVA1C475M8R	K78120031		1-	A	B3
C 1156	CHIP TA.CAP.	4.7uF	16V		TEESVA1C475M8R	K78120031		1-	A	B4
C 1157	CHIP CAP.	560pF	50V	CH	GRM1882C1H561JA01D	K22174273		1-	A	F5
C 1158	CHIP CAP.	390pF	50V	CH	GRM1882C1H391JA01D	K22174255		1-	A	F6

REF	DESCRIPTION	VALUE	V/W	TOL.	MFR'S DESIG	VXSTD P/N	VERS.	LOT	SIDE	LAY ADR
C 1159	CHIP CAP.	390pF	50V	CH	GRM1882C1H391JA01D	K22174255		1-	A	F6
C 1160	CHIP CAP.	330pF	50V	CH	GRM1882C1H331JA01D	K22174253		1-	A	F6
C 1161	CHIP TA.CAP.	0.47uF	35V		TEESVA1V474M8R	K78160029		1-	A	J5
C 1163	CHIP CAP.	0.0027uF	50V	CH	GRM1882C1H272JA01D	K22174280		1-	A	C2
C 1164	CHIP CAP.	27pF	50V	CH	GRM1882C1H270JA01D	K22174221		1-	A	B2
C 1165	CHIP CAP.	47pF	50V	CH	GRM1882C1H470JA01D	K22174227		1-	A	B2
C 1167	CHIP CAP.	33pF	50V	CH	GRM1882C1H330JA01D	K22174223		1-	A	F5
C 1168	CHIP CAP.	0.1uF	16V	B	GRM188B11C104KA01D	K22124805		1-	A	G5
C 1169	CHIP CAP.	68pF	50V	CH	GRM1882C1H680JA01D	K22174231		1-	A	F6
C 1170	CHIP CAP.	0.1uF	16V	B	GRM188B11C104KA01D	K22124805		1-	A	G6
C 1171	CHIP CAP.	18pF	50V	CH	GRM1882C1H180JA01D	K22174217		1-	A	F6
C 1172	CHIP CAP.	0.1uF	16V	B	GRM188B11C104KA01D	K22124805		1-	A	G6
C 1173	CHIP CAP.	56pF	50V	CH	GRM1882C1H560JA01D	K22174229		1-	A	F6
C 1174	CHIP CAP.	0.1uF	16V	B	GRM188B11C104KA01D	K22124805		1-	A	G6
C 1175	CHIP CAP.	180pF	50V	CH	GRM1882C1H181JA01D	K22174241		1-	A	A3
C 1176	CHIP CAP.	270pF	50V	CH	GRM1882C1H271JA01D	K22174251		1-	A	A3
C 1177	CHIP CAP.	390pF	50V	CH	GRM1882C1H391JA01D	K22174255		1-	A	A4
C 1179	CHIP CAP.	82pF	50V	CH	GRM1882C1H820JA01D	K22174233		1-	A	B1
C 1180	CHIP CAP.	68pF	50V	CH	GRM1882C1H680JA01D	K22174231		1-	A	A3
C 1181	CHIP CAP.	10pF	50V	CH	GRM1882C1H100JA01D	K22174211		1-	A	A3
C 1182	CHIP CAP.	10pF	50V	CH	GRM1882C1H100JA01D	K22174211		1-	A	A4
C 1184	CHIP CAP.	0.0012uF	50V	CH	GRM1882C1H122JA01D	K22174276		1-	A	C2
C 1185	CHIP CAP.	150pF	50V	CH	GRM1882C1H151JA01D	K22174239		1-	A	F5
C 1186	CHIP CAP.	0.0015uF	50V	CH	GRM1882C1H152JA01D	K22174277		1-	A	F5
C 1187	CHIP CAP.	4pF	50V	CH	GRM1882C1H4R0CZ01D	K22174205		1-	A	F5
C 1188	CHIP CAP.	120pF	50V	CH	GRM1882C1H121JA01D	K22174237		1-	A	F6
C 1189	CHIP CAP.	2pF	50V	CK	GRM1884C1H2R0CZ01D	K22174203		1-	A	F6
C 1190	CHIP CAP.	39pF	50V	CH	GRM1882C1H390JA01D	K22174225		1-	A	F6
C 1191	CHIP CAP.	1pF	50V	CK	GRM1884C1H1R0CZ01D	K22174202		1-	A	F6
C 1192	CHIP CAP.	12pF	50V	CH	GRM1882C1H120JA01D	K22174213		1-	A	F6
C 1193	CHIP CAP.	0.01uF	50V	B	GRM188B11H103KA01D	K22174823		1-	A	B3
C 1194	CHIP CAP.	0.01uF	50V	B	GRM188B11H103KA01D	K22174823		1-	A	B3
C 1195	CHIP CAP.	0.01uF	50V	B	GRM188B11H103KA01D	K22174823		1-	A	B3
C 1196	CHIP CAP.	0.01uF	50V	B	GRM188B11H103KA01D	K22174823		1-	A	B4
C 1197	CHIP CAP.	0.1uF	16V	B	GRM188B11C104KA01D	K22124805		1-	A	B2
C 1200	CHIP CAP.	180pF	50V	CH	GRM1882C1H181JA01D	K22174241		1-	A	I2
C 1201	CHIP CAP.	3pF	50V	CJ	GRM1883C1H3R0CZ01D	K22174204		1-	A	B3
C 1202	CHIP CAP.	8pF	50V	CH	GRM1882C1H8R0DZ01D	K22174209		1-	A	B4
C 1203	CHIP CAP.	4pF	50V	CH	GRM1882C1H4R0CZ01D	K22174205		1-	A	B3
C 1204	CHIP CAP.	22pF	50V	CH	GRM1882C1H220JA01D	K22174219		1-	A	B3
C 1205	CHIP CAP.	12pF	50V	CH	GRM1882C1H120JA01D	K22174213		1-	A	B3
C 1206	CHIP CAP.	10pF	50V	CH	GRM1882C1H100JA01D	K22174211		1-	A	B4
C 1207	CHIP CAP.	68pF	50V	CH	GRM1882C1H680JA01D	K22174231		1-	A	B1
C 1208	CHIP TA.CAP.	47uF	16V		TEESVC1C476M12R	K78120057		1-	A	H5
C 1209	CHIP CAP.	0.0012uF	50V	CH	GRM1882C1H122JA01D	K22174276		1-	A	C2
C 1210	CHIP CAP.	18pF	50V	CH	GRM1882C1H180JA01D	K22174217		1-	A	F5
C 1211	CHIP CAP.	0.01uF	50V	B	GRM188B11H103KA01D	K22174823		1-	A	F5
C 1213	CHIP CAP.	0.01uF	50V	B	GRM188B11H103KA01D	K22174823		1-	A	F6
C 1214	CHIP CAP.	4pF	50V	CH	GRM1882C1H4R0CZ01D	K22174205		1-	A	F6
C 1215	CHIP CAP.	0.01uF	50V	B	GRM188B11H103KA01D	K22174823		1-	A	F6
C 1217	CHIP CAP.	0.01uF	50V	B	GRM188B11H103KA01D	K22174823		1-	A	F6
C 1218	CHIP CAP.	27pF	50V	CH	GRM1882C1H270JA01D	K22174221		1-	A	B3
C 1219	CHIP CAP.	100pF	50V	CH	GRM1882C1H101JA01D	K22174235		1-	A	B4
C 1220	CHIP CAP.	8pF	50V	CH	GRM1882C1H8R0DZ01D	K22174209		1-	A	C1
C 1221	CHIP CAP.	0.1uF	16V	B	GRM188B11C104KA01D	K22124805		1-	A	B2
C 1222	CHIP CAP.	0.1uF	16V	B	GRM188B11C104KA01D	K22124805		1-	A	B3
C 1223	CHIP CAP.	56pF	50V	CH	GRM1882C1H560JA01D	K22174229		1-	A	B3
C 1224	CHIP CAP.	0.1uF	16V	B	GRM188B11C104KA01D	K22124805		1-	A	B3
C 1225	CHIP CAP.	0.1uF	16V	B	GRM188B11C104KA01D	K22124805		1-	A	B4
C 1226	CHIP TA.CAP.	47uF	16V		TEESVC1C476M12R	K78120057		1-	A	G4
C 1227	CHIP CAP.	22pF	50V	CH	GRM1882C1H220JA01D	K22174219		1-	A	B3
C 1228	CHIP CAP.	68pF	50V	CH	GRM1882C1H680JA01D	K22174231		1-	A	B3
C 1229	CHIP CAP.	120pF	50V	CH	GRM1882C1H121JA01D	K22174237		1-	A	B4
C 1230	CHIP CAP.	15pF	50V	CH	GRM1882C1H150JA01D	K22174215		1-	A	B1
C 1231	CHIP CAP.	180pF	50V	CH	GRM1882C1H181JA01D	K22174241		1-	A	F5
C 1232	CHIP CAP.	150pF	50V	CH	GRM1882C1H151JA01D	K22174239		1-	A	F6
C 1233	CHIP CAP.	120pF	50V	CH	GRM1882C1H121JA01D	K22174237		1-	A	F6
C 1234	CHIP CAP.	180pF	50V	CH	GRM1882C1H181JA01D	K22174241		1-	A	F6
C 1235	CHIP CAP.	0.01uF	50V	B	GRM188B11H103KA01D	K22174823		1-	A	D1
C 1236	CHIP CAP.	0.1uF	16V	B	GRM188B11C104KA01D	K22124805		1-	A	F5
C 1237	CHIP CAP.	0.1uF	16V	B	GRM188B11C104KA01D	K22124805		1-	A	F6
C 1238	CHIP CAP.	0.1uF	16V	B	GRM188B11C104KA01D	K22124805		1-	A	F6
C 1239	CHIP CAP.	0.1uF	16V	B	GRM188B11C104KA01D	K22124805		1-	A	F6

TRX Unit

Parts List

REF	DESCRIPTION	VALUE	V/W	TOL.	MFR'S DESIG	VXSTD P/N	VERS.	LOT	SIDE	LAY ADR
C 1240	CHIP CAP.	0.001uF	50V	B	GRM188B11H102KA01D	K22174821		1-	A	D2
C 1241	CHIP CAP.	0.1uF	16V	B	GRM188B11C104KA01D	K22124805		1-	A	H5
C 1242	CHIP CAP.	0.0012uF	50V	CH	GRM1882C1H122JA01D	K22174276		1-	A	C2
C 1243	CHIP CAP.	0.01uF	50V	B	GRM188B11H103KA01D	K22174823		1-	A	B2
C 1244	CHIP CAP.	0.01uF	50V	B	GRM188B11H103KA01D	K22174823		1-	A	B3
C 1245	CHIP CAP.	0.01uF	50V	B	GRM188B11H103KA01D	K22174823		1-	A	B3
C 1246	CHIP CAP.	0.01uF	50V	B	GRM188B11H103KA01D	K22174823		1-	A	B4
C 1247	CHIP CAP.	22pF	50V	CH	GRM1882C1H220JA01D	K22174219		1-	A	C1
C 1248	CHIP TA.CAP.	10uF	16V		TEESVB21C106M8R	K78120025		1-	A	E1
C 1249	CHIP CAP.	15pF	50V	CH	GRM1882C1H150JA01D	K22174215		1-	A	C1
C 1250	CHIP CAP.	0.0027uF	50V	CH	GRM1882C1H272JA01D	K22174280		1-	A	C2
C 1251	CHIP CAP.	0.001uF	50V	B	GRM188B11H102KA01D	K22174821		1-	A	F5
C 1252	CHIP CAP.	100pF	50V	CH	GRM1882C1H101JA01D	K22174235		1-	A	D2
C 1253	CHIP CAP.	0.01uF	50V	B	GRM188B11H103KA01D	K22174823		1-	A	A4
C 1254	CHIP CAP.	0.01uF	50V	B	GRM188B11H103KA01D	K22174823		1-	A	A5
C 1255	CHIP CAP.	0.01uF	50V	B	GRM188B11H103KA01D	K22174823		1-	A	A5
C 1256	CHIP CAP.	0.1uF	16V	B	GRM188B11C104KA01D	K22124805		1-	A	C5
C 1257	CHIP TA.CAP.	10uF	16V		TEESVA1C106M8R	K78120077		1-	A	C5
C 1258	AL.ELECTRO.CAP.	47uF	16V		EEE1CA470SP	K48120005		1-	A	H5
C 1259	CHIP CAP.	0.01uF	50V	B	GRM188B11H103KA01D	K22174823		1-	A	F5
C 1262	CHIP CAP.	68pF	50V	CH	GRM1882C1H680JA01D	K22174231		1-	A	A5
C 1263	CHIP CAP.	68pF	50V	CH	GRM1882C1H680JA01D	K22174231		1-	A	A5
C 1264	CHIP CAP.	0.1uF	16V	B	GRM188B11C104KA01D	K22124805		1-	A	H5
C 1265	CHIP CAP.	0.1uF	16V	B	GRM188B11C104KA01D	K22124805		1-	A	A4
C 1266	CHIP CAP.	0.1uF	16V	B	GRM188B11C104KA01D	K22124805		1-	A	A5
C 1267	CHIP CAP.	0.1uF	16V	B	GRM188B11C104KA01D	K22124805		1-	A	A5
C 1268	CHIP CAP.	0.01uF	50V	B	GRM188B11H103KA01D	K22174823		1-	A	C2
C 1269	CHIP CAP.	0.1uF	16V	B	GRM188B11C104KA01D	K22124805		1-	A	F5
C 1270	CHIP CAP.	220pF	50V	CH	GRM1882C1H221JA01D	K22174243		1-	A	A4
C 1271	CHIP CAP.	390pF	50V	CH	GRM1882C1H391JA01D	K22174255		1-	A	A5
C 1272	CHIP CAP.	820pF	50V	CH	GRM1882C1H821JA01D	K22174283		1-	A	A5
C 1273	CHIP CAP.	0.0015uF	50V	CH	GRM1882C1H152JA01D	K22174277		1-	A	B3
C 1275	CHIP CAP.	0.1uF	16V	B	GRM188B11C104KA01D	K22124805		1-	A	B5
C 1276	CHIP CAP.	68pF	50V	CH	GRM1882C1H680JA01D	K22174231		1-	A	A5
C 1277	CHIP CAP.	0.1uF	16V	B	GRM188B11C104KA01D	K22124805		1-	A	B5
C 1278	CHIP CAP.	68pF	50V	CH	GRM1882C1H680JA01D	K22174231		1-	A	A5
C 1279	CHIP CAP.	0.1uF	16V	B	GRM188B11C104KA01D	K22124805		1-	A	B5
C 1281	CHIP CAP.	0.1uF	16V	B	GRM188B11C104KA01D	K22124805		1-	A	H4
C 1282	CHIP CAP.	180pF	50V	CH	GRM1882C1H181JA01D	K22174241		1-	A	A4
C 1283	CHIP CAP.	390pF	50V	CH	GRM1882C1H391JA01D	K22174255		1-	A	A5
C 1284	CHIP CAP.	820pF	50V	CH	GRM1882C1H821JA01D	K22174283		1-	A	A5
C 1287	CHIP CAP.	680pF	50V	CH	GRM1882C1H681JA01D	K22174274		1-	A	A4
C 1288	CHIP TA.CAP.	4.7uF	16V		TEESVA1C475M8R	K78120031		1-	A	B5
C 1289	CHIP TA.CAP.	4.7uF	16V		TEESVA1C475M8R	K78120031		1-	A	B5
C 1290	CHIP TA.CAP.	4.7uF	16V		TEESVA1C475M8R	K78120031		1-	A	B5
C 1291	CHIP CAP.	0.0033uF	50V	CH	GRM1882C1H332JA01D	K22174281		1-	A	B3
C 1292	CHIP CAP.	10pF	50V	CH	GRM1882C1H100JA01D	K22174211		1-	A	E5
C 1293	CHIP CAP.	0.1uF	16V	B	GRM188B11C104KA01D	K22124805		1-	A	H5
C 1294	AL.ELECTRO.CAP.	100uF	16V		EEE1CA101WP	K48120012		1-7	A	D1
C 1294	CHIP TA.CAP.	100uF	16V		TEESVD1C107M12R	K78120059	W/ CE LABEL	8-	A	D1
C 1294	AL.ELECTRO.CAP.	100uF	16V		EEE1CA101WP	K48120012	W/O CE LABEL	8-	A	D1
C 1294	CHIP TA.CAP.	100uF	16V		TEESVD1C107M12R	K78120059	W/O CE LABEL	11-	A	D1
C 1295	CHIP CAP.	0.0012uF	50V	CH	GRM1882C1H122JA01D	K22174276		1-	A	A5
C 1296	CHIP CAP.	0.0027uF	50V	CH	GRM1882C1H272JA01D	K22174280		1-	A	A5
C 1297	CHIP CAP.	0.01uF	50V	B	GRM188B11H103KA01D	K22174823		1-	A	G3
C 1298	CHIP CAP.	100pF	50V	CH	GRM1882C1H101JA01D	K22174235		1-	A	G5
C 1300	CHIP CAP.	100pF	50V	CH	GRM1882C1H101JA01D	K22174235		1-	A	G5
C 1301	CHIP CAP.	100pF	50V	CH	GRM1882C1H101JA01D	K22174235		1-	A	B3
C 1302	AL.ELECTRO.CAP.	47uF	16V		EEE1CA470SP	K48120005		1-	A	H5
C 1305	CHIP CAP.	68pF	50V	CH	GRM1882C1H680JA01D	K22174231		1-	A	A5
C 1306	AL.ELECTRO.CAP.	22uF	16V		EEE1CA220SR	K48120024		1-	A	G3
C 1307	CHIP TA.CAP.	47uF	16V		TEESVC1C476M12R	K78120057		1-	A	G4
C 1308	CHIP CAP.	0.1uF	16V	B	GRM188B11C104KA01D	K22124805		1-	A	G5
C 1309	CHIP CAP.	0.01uF	50V	B	GRM188B11H103KA01D	K22174823		1-	A	B5
C 1310	CHIP CAP.	0.01uF	50V	B	GRM188B11H103KA01D	K22174823		1-	A	B5
C 1311	CHIP CAP.	0.01uF	50V	B	GRM188B11H103KA01D	K22174823		1-	A	B5
C 1312	CHIP CAP.	0.0033uF	50V	CH	GRM1882C1H332JA01D	K22174281		1-	A	B3
C 1313	CHIP TA.CAP.	10uF	16V		TEESVB21C106M8R	K78120025		1-	A	E1
C 1315	CHIP CAP.	68pF	50V	CH	GRM1882C1H680JA01D	K22174231		1-	A	B5
C 1316	CHIP CAP.	68pF	50V	CH	GRM1882C1H680JA01D	K22174231		1-	A	B5
C 1317	CHIP CAP.	100pF	50V	CH	GRM1882C1H101JA01D	K22174235		1-	A	B3
C 1318	CHIP CAP.	0.01uF	50V	B	GRM188B11H103KA01D	K22174823		1-	A	D1
C 1319	CHIP CAP.	0.001uF	50V	B	GRM188B11H102KA01D	K22174821		1-	A	E4

REF	DESCRIPTION	VALUE	V/W	TOL.	MFR'S DESIG	VXSTD P/N	VERS.	LOT	SIDE	LAY ADR
C 1320	CHIP CAP.	180pF	50V	CH	GRM1882C1H181JA01D	K22174241		1-	A	B4
C 1321	CHIP CAP.	390pF	50V	CH	GRM1882C1H391JA01D	K22174255		1-	A	B5
C 1322	CHIP CAP.	820pF	50V	CH	GRM1882C1H821JA01D	K22174283		1-	A	B5
C 1323	CHIP CAP.	220pF	50V	CH	GRM1882C1H221JA01D	K22174243		1-	A	B4
C 1324	CHIP CAP.	390pF	50V	CH	GRM1882C1H391JA01D	K22174255		1-	A	B5
C 1325	CHIP CAP.	820pF	50V	CH	GRM1882C1H821JA01D	K22174283		1-	A	B5
C 1326	CHIP CAP.	0.1uF	16V	B	GRM188B11C104KA01D	K22124805		1-	A	E4
C 1327	CHIP CAP.	0.1uF	16V	B	GRM188B11C104KA01D	K22124805		1-	A	B4
C 1328	CHIP CAP.	0.1uF	16V	B	GRM188B11C104KA01D	K22124805		1-	A	B5
C 1329	CHIP CAP.	0.1uF	16V	B	GRM188B11C104KA01D	K22124805		1-	A	B5
C 1330	CHIP CAP.	0.0015uF	50V	CH	GRM1882C1H152JA01D	K22174277		1-	A	B3
C 1332	CHIP CAP.	68pF	50V	CH	GRM1882C1H680JA01D	K22174231		1-	A	B5
C 1333	CHIP CAP.	68pF	50V	CH	GRM1882C1H680JA01D	K22174231		1-	A	B5
C 1334	CHIP CAP.	39pF	50V	CH	GRM1882C1H390JA01D	K22174225		1-	A	E5
C 1335	CHIP TA.CAP.	1uF	35V		TEESVA1V105M8R	K78160032		1-	A	H5
C 1336	CHIP TA.CAP.	1uF	35V		TEESVA1V105M8R	K78160032		1-	A	H5
C 1337	CHIP CAP.	0.01uF	50V	B	GRM188B11H103KA01D	K22174823		1-	A	E4
C 1338	CHIP CAP.	8pF	50V	CH	GRM1882C1H8R0DZ01D	K22174209		1-	A	E5
C 1339	CHIP CAP.	0.0015uF	50V	CH	GRM1882C1H152JA01D	K22174277		1-	A	G3
C 1340	CHIP CAP.	0.1uF	16V	B	GRM188B11C104KA01D	K22124805		1-	A	C4
C 1342	CHIP CAP.	0.01uF	50V	B	GRM188B11H103KA01D	K22174823		1-	A	B4
C 1343	CHIP CAP.	0.01uF	50V	B	GRM188B11H103KA01D	K22174823		1-	A	B5
C 1344	CHIP CAP.	0.01uF	50V	B	GRM188B11H103KA01D	K22174823		1-	A	B5
C 1345	CHIP CAP.	82pF	50V	CH	GRM1882C1H820JA01D	K22174233		1-	A	E5
C 1346	CHIP CAP.	0.027uF	25V	B	GRM188B11E273KA01D	K22144810		1-	A	G3
C 1347	CHIP CAP.	0.1uF	16V	B	GRM188B11C104KA01D	K22124805		1-	A	B2
C 1349	CHIP CAP.	0.001uF	50V	B	GRM188B11H102KA01D	K22174821		1-	A	A6
C 1350	CHIP CAP.	0.01uF	50V	B	GRM188B11H103KA01D	K22174823		1-	A	A6
C 1351	CHIP CAP.	0.1uF	16V	B	GRM188B11C104KA01D	K22124805		1-	A	A6
C 1352	CHIP CAP.	0.001uF	50V	B	GRM188B11H102KA01D	K22174821		1-	A	E5
C 1353	CHIP CAP.	39pF	50V	CH	GRM1882C1H390JA01D	K22174225		1-	A	E5
C 1354	CHIP CAP.	47pF	50V	CH	GRM1882C1H470JA01D	K22174227		1-	A	H5
C 1355	CHIP TA.CAP.	1uF	35V		TEESVA1V105M8R	K78160032		1-	A	G3
C 1356	CHIP CAP.	47pF	50V	CH	GRM1882C1H470JA01D	K22174227		1-	A	G5
C 1357	CHIP CAP.	220pF	50V	CH	GRM1882C1H221JA01D	K22174243		1-	A	I5
C 1358	CHIP CAP.	0.1uF	16V	B	GRM188B11C104KA01D	K22124805		1-	A	B6
C 1359	CHIP CAP.	0.001uF	50V	B	GRM188B11H102KA01D	K22174821		1-	A	B6
C 1360	CHIP CAP.	15pF	50V	CH	GRM1882C1H150JA01D	K22174215		1-	A	F4
C 1361	CHIP CAP.	0.01uF	50V	B	GRM188B11H103KA01D	K22174823		1-	A	F5
C 1362	AL.ELECTRO.CAP.	220uF	10V		RV3-10V221MF80-R	K48100002		1-	A	H6
C 1363	CHIP TA.CAP.	1uF	35V		TEESVA1V105M8R	K78160032		1-	A	H4
C 1364	CHIP CAP.	0.01uF	50V	B	GRM188B11H103KA01D	K22174823		1-	A	I5
C 1366	CHIP CAP.	0.1uF	16V	B	GRM188B11C104KA01D	K22124805		1-	A	B6
C 1367	AL.ELECTRO.CAP.	10uF	16V		RV4-16V100MD46-RR2	K48120018		1-	A	B5
C 1368	CHIP CAP.	220pF	50V	CH	GRM1882C1H221JA01D	K22174243		1-	A	G5
C 1369	CHIP CAP.	0.1uF	16V	B	GRM188B11C104KA01D	K22124805		1-	A	G5
C 1370	CHIP CAP.	0.01uF	50V	B	GRM188B11H103KA01D	K22174823		1-	A	E4
C 1371	AL.ELECTRO.CAP.	220uF	10V		RV3-10V221MF80-R	K48100002		1-	A	H5
C 1372	CHIP CAP.	0.001uF	50V	B	GRM188B11H102KA01D	K22174821		1-	A	B6
C 1373	CHIP CAP.	0.1uF	16V	B	GRM188B11C104KA01D	K22124805		1-	A	B5
C 1374	CHIP CAP.	0.022uF	50V	CH	GRM21B2C1H223JA01L	K22170292		1-	A	I2
C 1375	CHIP CAP.	0.0047uF	50V	B	GRM188B11H472KA01D	K22174833		1-	A	G1
C 1376	CHIP CAP.	0.001uF	50V	B	GRM188B11H102KA01D	K22174821		1-	A	B6
C 1377	CHIP CAP.	0.001uF	50V	B	GRM188B11H102KA01D	K22174821		1-	A	E4
C 1378	CHIP CAP.	0.01uF	50V	B	GRM188B11H103JA01D	K22174824		1-	A	G3
C 1379	CHIP CAP.	0.1uF	16V	B	GRM188B11C104KA01D	K22124805		1-	A	B6
C 1380	CHIP CAP.	47pF	50V	CH	GRM1882C1H470JA01D	K22174227		1-	A	H5
C 1381	CHIP CAP.	0.01uF	50V	B	GRM188B11H103KA01D	K22174823		1-	A	E4
C 1382	CHIP CAP.	0.01uF	50V	B	GRM188B11H103KA01D	K22174823		1-	A	G1
C 1383	CHIP CAP.	47pF	50V	CH	GRM1882C1H470JA01D	K22174227		1-	A	G5
C 1384	CHIP CAP.	0.1uF	16V	B	GRM188B11C104KA01D	K22124805		1-	A	G4
C 1385	CHIP CAP.	0.01uF	50V	B	GRM188B11H103JA01D	K22174824		1-	A	A6
C 1386	CHIP CAP.	0.1uF	16V	B	GRM188B11C104KA01D	K22124805		1-	A	B6
C 1387	CHIP CAP.	56pF	50V	CH	GRM1882C1H560JA01D	K22174229		1-	A	H2
C 1388	CHIP CAP.	0.1uF	16V	B	GRM188B11C104KA01D	K22124805		1-	A	B6
C 1389	CHIP TA.CAP.	10uF	16V		TEESVB21C106M8R	K78120025		1-	A	G4
C 1390	CHIP TA.CAP.	0.1uF	35V		TEESVA1V104M8R	K78160025		1-	A	G1
C 1391	CHIP CAP.	0.1uF	16V	B	GRM188B11C104KA01D	K22124805		1-	A	A6
C 1392	CHIP CAP.	0.001uF	50V	B	GRM188B11H102KA01D	K22174821		1-	A	A6
C 1393	CHIP TA.CAP.	1uF	35V		TEESVA1V105M8R	K78160032		1-	A	G3
C 1394	AL.ELECTRO.CAP.	220uF	16V		EMVA160ADA221MF80G	K48120021		1-	A	I5
C 1395	CHIP CAP.	10pF	50V	CH	GRM1882C1H100JA01D	K22174211		1-	A	E4
C 1396	CHIP CAP.	0.01uF	50V	B	GRM188B11H103KA01D	K22174823		1-	A	B6

TRX Unit

Parts List

REF	DESCRIPTION	VALUE	V/W	TOL.	MFR'S DESIG	VXSTD P/N	VERS.	LOT	SIDE	LAY ADR
C 1397	CHIP CAP.	0.047uF	25V	B	GRM188B11E473KA01D	K22144811		1-	A	G4
C 1399	CHIP CAP.	0.01uF	50V	B	GRM188B11H103KA01D	K22174823		1-	A	E4
C 1400	CHIP CAP.	0.1uF	16V	B	GRM188B11C104KA01D	K22124805		1-	A	A6
C 1401	CHIP TA.CAP.	10uF	16V		TEESVA1C106M8R	K78120077		1-	A	I2
C 1403	CHIP CAP.	0.01uF	50V	B	GRM188B11H103KA01D	K22174823		1-	A	E4
C 1404	CHIP CAP.	0.01uF	50V	B	GRM188B11H103KA01D	K22174823		1-	A	E4
C 1405	CHIP CAP.	0.01uF	50V	B	GRM188B11H103KA01D	K22174823		1-	A	G5
C 1407	CHIP CAP.	0.1uF	16V	B	GRM188B11C104KA01D	K22124805		1-	A	I5
C 1409	CHIP CAP.	0.001uF	50V	B	GRM188B11H102KA01D	K22174821		1-	A	A6
C 1410	CHIP CAP.	0.1uF	16V	B	GRM188B11C104KA01D	K22124805		1-	A	I2
C 1411	AL.ELECTRO.CAP.	47uF	16V		EEE1CA470WR	K48120025		1-	A	I5
C 1412	CHIP CAP.	0.001uF	50V	B	GRM188B11H102KA01D	K22174821		1-	A	A6
C 1413	CHIP CAP.	0.1uF	16V	B	GRM188B11C104KA01D	K22124805		1-	A	A6
C 1414	CHIP CAP.	15pF	50V	CH	GRM1882C1H150JA01D	K22174215		1-	A	E4
C 1415	CHIP CAP.	0.01uF	50V	B	GRM188B11H103KA01D	K22174823		1-	A	E4
C 1416	CHIP CAP.	0.01uF	50V	B	GRM188B11H103KA01D	K22174823		1-	A	G5
C 1417	CHIP TA.CAP.	10uF	16V		TEESVA1C106M8R	K78120077		1-	A	H2
C 1418	CHIP CAP.	0.01uF	50V	B	GRM188B11H103KA01D	K22174823		1-	A	H4
C 1419	CHIP CAP.	0.0022uF	50V	B	GRM188B11H222KA01D	K22174822		1-	A	I5
C 1419	CHIP CAP.	0.001uF	50V	B	GRM188B11H102KA01D	K22174821		4-	A	I5
C 1422	CHIP CAP.	0.1uF	16V	B	GRM188B11C104KA01D	K22124805		1-	A	A6
C 1423	AL.ELECTRO.CAP.	47uF	16V		EEE1CA470WR	K48120025		1-	A	H4
C 1424	CHIP CAP.	0.1uF	16V	B	GRM188B11C104KA01D	K22124805		1-	A	A6
C 1425	CHIP CAP.	0.1uF	16V	B	GRM188B11C104KA01D	K22124805		1-	A	H2
C 1426	CHIP CAP.	0.0047uF	50V	B	GRM188B11H472KA01D	K22174817		1-	A	D2
C 1427	CHIP CAP.	0.001uF	50V	B	GRM188B11H102KA01D	K22174821		1-	A	E4
C 1428	CHIP CAP.	0.047uF	25V	B	GRM188B11E473KA01D	K22144811		1-	A	G4
C 1429	CHIP TA.CAP.	0.1uF	35V		TEESVA1V104M8R	K78160025		1-	A	H4
C 1430	CHIP CAP.	0.001uF	50V	B	GRM188B11H102KA01D	K22174821		1-	A	B6
C 1431	CHIP CAP.	0.01uF	50V	B	GRM188B11H103KA01D	K22174823		1-	A	B6
C 1432	CHIP CAP.	0.1uF	16V	B	GRM188B11C104KA01D	K22124805		1-	A	B6
C 1433	CHIP CAP.	10pF	50V	CH	GRM1882C1H100JA01D	K22174211		1-	A	F4
C 1434	CHIP CAP.	0.01uF	50V	B	GRM188B11H103JA01D	K22174824		1-	A	B6
C 1435	CHIP CAP.	0.001uF	50V	CH	GRM1882C1H102JA01D	K22174275		1-	A	I2
C 1436	CHIP CAP.	0.01uF	50V	B	GRM188B11H103KA01D	K22174823		1-	A	E4
C 1437	CHIP TA.CAP.	0.1uF	35V		TEESVA1V104M8R	K78160025		1-	A	H4
C 1438	CHIP TA.CAP.	1uF	35V		TEESVA1V105M8R	K78160032		1-	A	I5
C 1438	CHIP TA.CAP.	0.22uF	35V		TEESVA1V224M8R	K78160027		4-	A	I5
C 1440	CHIP CAP.	10pF	50V	CH	GRM1882C1H100JA01D	K22174211		1-	A	E4
C 1441	CHIP CAP.	0.01uF	50V	B	GRM188B11H103KA01D	K22174823		1-	A	I5
C 1442	CHIP CAP.	0.01uF	50V	B	GRM188B11H103KA01D	K22174823		1-	A	C6
C 1443	AL.ELECTRO.CAP.	47uF	16V		EEE1CA470WR	K48120025		1-	A	H4
C 1444	CHIP CAP.	15pF	50V	CH	GRM1882C1H150JA01D	K22174215		1-	A	E4
C 1446	CHIP CAP.	0.001uF	50V	CH	GRM1882C1H102JA01D	K22174275		1-	A	H2
C 1447	CHIP TA.CAP.	1uF	35V		TEESVA1V105M8R	K78160032		1-	A	E4
C 1448	CHIP TA.CAP.	1uF	35V		TEESVA1V105M8R	K78160032		1-	A	I4
C 1449	CHIP CAP.	0.0022uF	50V	B	GRM188B11H222KA01D	K22174822		1-	A	I5
C 1450	CHIP CAP.	330pF	50V	CH	GRM1882C1H331JA01D	K22174253		1-	A	B6
C 1451	CHIP CAP.	0.1uF	16V	B	GRM188B11C104KA01D	K22124805		1-	A	C6
C 1452	CHIP TA.CAP.	0.22uF	35V		TEESVA1V224M8R	K78160027		1-	A	G5
C 1453	CHIP CAP.	0.001uF	50V	CH	GRM1882C1H102JA01D	K22174275		1-	A	H2
C 1454	AL.ELECTRO.CAP.	100uF	16V		EEE1CA101WP	K48120012		1-	A	D2
C 1456	CHIP CAP.	0.0022uF	50V	B	GRM188B11H222KA01D	K22174822		1-	A	I5
C 1457	CHIP CAP.	56pF	50V	CH	GRM1882C1H560JA01D	K22174229		1-	A	D6
C 1458	CHIP CAP.	36pF	50V	CH	GRM1882C1H360JZ01D	K22174224		1-	A	D6
C 1459	CHIP CAP.	36pF	50V	CH	GRM1882C1H360JZ01D	K22174224		1-	A	D6
C 1460	CHIP CAP.	56pF	50V	CH	GRM1882C1H560JA01D	K22174229		1-	A	D6
C 1461	CHIP CAP.	330pF	50V	CH	GRM1882C1H331JA01D	K22174253		1-	A	C6
C 1462	CHIP CAP.	0.01uF	50V	B	GRM188B11H103KA01D	K22174823		1-	A	E4
C 1463	CHIP CAP.	0.1uF	16V	B	GRM188B11C104KA01D	K22124805		1-	A	D2
C 1465	CHIP CAP.	0.1uF	16V	B	GRM188B11C104KA01D	K22124805		1-	A	F5
C 1466	CHIP CAP.	0.1uF	16V	B	GRM188B11C104KA01D	K22124805		1-	A	G4
C 1467	CHIP CAP.	0.022uF	50V	CH	GRM21B2C1H223JA01L	K22170292		1-	A	H2
C 1469	CHIP TA.CAP.	1uF	35V		TEESVA1V105M8R	K78160032		1-	A	F5
C 1470	CHIP CAP.	0.1uF	16V	B	GRM188B11C104KA01D	K22124805		1-	A	D2
C 1471	CHIP TA.CAP.	1uF	35V		TEESVA1V105M8R	K78160032		1-	A	I4
C 1472	CHIP TA.CAP.	100uF	16V		TEESVD1C107M12R	K78120059		1-	A	F5
C 1473	CHIP CAP.	22pF	50V	CH	GRM1882C1H220JA01D	K22174219		1-	A	H4
C 1474	CHIP CAP.	0.01uF	50V	B	GRM188B11H103KA01D	K22174823		1-	A	D2
C 1475	CHIP CAP.	0.001uF	50V	B	GRM188B11H102KA01D	K22174821		1-	A	C6
C 1476	CHIP CAP.	0.01uF	50V	B	GRM188B11H103KA01D	K22174823		1-	A	E3
C 1477	CHIP TA.CAP.	47uF	16V		TEESVC1C476M12R	K78120057		1-	A	G4
C 1478	CHIP CAP.	0.01uF	50V	CH	GRM2192C1H103JA01D	K22170291		1-	A	H2

REF	DESCRIPTION	VALUE	V/W	TOL.	MFR'S DESIG	VXSTD P/N	VERS.	LOT	SIDE	LAY ADR
C 1479	CHIP CAP.	0.1uF	16V	B	GRM188B11C104KA01D	K22124805		1-	A	H4
C 1480	CHIP TA.CAP.	0.1uF	35V		TEESVA1V104M8R	K78160025		1-	A	H4
C 1481	CHIP CAP.	0.01uF	50V	B	GRM188B11H103KA01D	K22174823		1-	A	C6
C 1482	CHIP CAP.	0.001uF	50V	B	GRM188B11H102KA01D	K22174821		1-	A	E3
C 1484	CHIP CAP.	0.1uF	16V	B	GRM188B11C104KA01D	K22124805		1-	A	C6
C 1485	CHIP CAP.	47pF	50V	CH	GRM1882C1H470JA01D	K22174227		1-	A	G5
C 1486	CHIP TA.CAP.	10uF	16V		TEESVA1C106M8R	K78120077		1-	A	G5
C 1487	CHIP CAP.	0.001uF	50V	B	GRM188B11H102KA01D	K22174821		1-	A	C6
C 1488	CHIP CAP.	0.1uF	16V	B	GRM188B11C104KA01D	K22124805		1-	A	C6
C 1489	CHIP CAP.	0.001uF	50V	B	GRM188B11H102KA01D	K22174821		1-	A	C6
C 1490	CHIP CAP.	0.1uF	16V	B	GRM188B11C104KA01D	K22124805		1-	A	C6
C 1491	CHIP CAP.	0.1uF	16V	B	GRM188B11C104KA01D	K22124805		1-	A	H4
C 1492	CHIP TA.CAP.	0.1uF	35V		TEESVA1V104M8R	K78160025		1-	A	H4
C 1493	AL.ELECTRO.CAP.	220uF	10V		RV3-10V221MF80-R	K48100002		1-	A	I4
C 1494	CHIP CAP.	0.1uF	16V	B	GRM188B11C104KA01D	K22124805		1-	A	H4
C 1495	CHIP CAP.	2pF	50V	CK	GRM1884C1H2R0CZ01D	K22174203		1-	A	E6
C 1496	CHIP CAP.	39pF	50V	CH	GRM1882C1H390JA01D	K22174225		1-	A	E6
C 1497	CHIP CAP.	0.01uF	50V	B	GRM188B11H103KA01D	K22174823		1-	A	G5
C 1498	CHIP CAP.	0.001uF	50V	B	GRM188B11H102KA01D	K22174821		1-	A	D3
C 1499	CHIP CAP.	0.01uF	50V	B	GRM188B11H103KA01D	K22174823		1-	A	F3
C 1501	CHIP CAP.	0.01uF	50V	B	GRM188B11H103KA01D	K22174823		1-	A	F4
C 1502	CHIP CAP.	68pF	50V	CH	GRM1882C1H680JA01D	K22174231		1-	A	E6
C 1503	CHIP CAP.	0.01uF	50V	CH	GRM2192C1H103JA01D	K22170291		1-	A	C6
C 1504	CHIP CAP.	0.01uF	50V	CH	GRM2192C1H103JA01D	K22170291		1-	A	C6
C 1505	CHIP CAP.	15pF	50V	CH	GRM1882C1H150JA01D	K22174215		1-	A	F4
C 1506	CHIP CAP.	33pF	50V	CH	GRM1882C1H330JA01D	K22174223		1-	A	E6
C 1507	CHIP CAP.	0.1uF	16V	B	GRM188B11C104KA01D	K22124805		1-	A	I4
C 1508	CHIP CAP.	0.1uF	16V	B	GRM188B11C104KA01D	K22124805		1-	A	I4
C 1509	CHIP CAP.	0.001uF	50V	B	GRM188B11H102KA01D	K22174821		1-	A	D3
C 1510	CHIP CAP.	10pF	50V	CH	GRM1882C1H100JA01D	K22174211		1-	A	E6
C 1511	CHIP CAP.	15pF	50V	CH	GRM1882C1H150JA01D	K22174215		1-	A	D3
C 1511	CHIP CAP.	18pF	50V	CH	GRM1882C1H180JA01D	K22174217		5-	A	D3
C 1512	CHIP TA.CAP.	0.1uF	35V		TEESVA1V104M8R	K78160025		1-	A	E1
C 1513	CHIP CAP.	0.047uF	25V	B	GRM188B11E473KA01D	K22144811		1-	A	C6
C 1514	CHIP CAP.	0.001uF	50V	B	GRM188B11H102KA01D	K22174821		1-	A	C6
C 1515	CHIP TA.CAP.	0.1uF	35V		TEESVA1V104M8R	K78160025		1-	A	E1
C 1516	CHIP CAP.	0.01uF	50V	B	GRM188B11H103KA01D	K22174823		1-	A	E6
C 1517	CHIP TA.CAP.	0.1uF	35V		TEESVA1V104M8R	K78160025		1-	A	D2
C 1518	CHIP CAP.	0.001uF	50V	B	GRM188B11H102KA01D	K22174821		1-	A	C6
C 1519	CHIP CAP.	0.001uF	50V	B	GRM188B11H102KA01D	K22174821		1-	A	D3
C 1521	CHIP CAP.	0.001uF	50V	B	GRM188B11H102KA01D	K22174821		1-	A	D3
C 1522	CHIP TA.CAP.	1uF	35V		TEESVA1V105M8R	K78160032		1-	A	E6
C 1523	CHIP CAP.	0.01uF	50V	B	GRM188B11H103KA01D	K22174823		1-	A	F4
C 1524	CHIP CAP.	0.1uF	16V	B	GRM188B11C104KA01D	K22124805		1-	A	D6
C 1525	CHIP CAP.	470pF	50V	CH	GRM1882C1H471JA01D	K22174249		1-	A	E6
C 1526	CHIP CAP.	0.001uF	50V	B	GRM188B11H102KA01D	K22174821		1-	A	D6
C 1528	CHIP CAP.	0.01uF	50V	B	GRM188B11H103KA01D	K22174823		1-	A	I4
C 1529	CHIP CAP.	330pF	50V	CH	GRM1882C1H331JA01D	K22174253		1-	A	H3
C 1530	CHIP CAP.	0.001uF	50V	B	GRM188B11H102KA01D	K22174821		1-	A	F4
C 1531	CHIP CAP.	0.1uF	16V	B	GRM188B11C104KA01D	K22124805		1-	A	C6
C 1532	CHIP TA.CAP.	1uF	35V		TEESVA1V105M8R	K78160032		1-	A	I4
C 1533	CHIP CAP.	0.01uF	50V	B	GRM188B11H103KA01D	K22174823		1-	A	F3
C 1534	CHIP CAP.	0.047uF	25V	B	GRM188B11E473KA01D	K22144811		1-	A	C6
C 1535	CHIP CAP.	0.1uF	16V	B	GRM188B11C104KA01D	K22124805		1-	A	D2
C 1536	CHIP TA.CAP.	10uF	10V		TEESVB21A106M8R	K78100017		1-	A	C6
C 1537	CHIP CAP.	1uF	16V	B	C1608JB1C105KT	K22124813		1-	A	D3
C 1538	AL.ELECTRO.CAP.	100uF	16V		EEE1CA101WP	K48120012		1-	A	E6
C 1539	CHIP CAP.	0.01uF	50V	B	GRM188B11H103KA01D	K22174823		1-	A	E6
C 1540	AL.ELECTRO.CAP.	47uF	16V		EEE1CA470SP	K48120005		1-	A	D2
C 1541	CHIP CAP.	0.01uF	50V	CH	GRM2192C1H103JA01D	K22170291		1-	A	D5
C 1543	CHIP TA.CAP.	0.1uF	35V		TEESVA1V104M8R	K78160025		1-	A	I3
C 1544	CHIP CAP.	0.01uF	50V	B	GRM188B11H103KA01D	K22174823		1-	A	E6
C 1545	CHIP CAP.	1uF	16V	B	C1608JB1C105KT	K22124813		1-	A	G3
C 1546	CHIP CAP.	0.01uF	50V	B	GRM188B11H103KA01D	K22174823		1-	A	E3
C 1547	CHIP TA.CAP.	0.47uF	35V		TEESVA1V474M8R	K78160029		1-	A	H3
C 1548	CHIP TA.CAP.	10uF	16V		TEESVA1C106M8R	K78120077		1-	A	E6
C 1549	CHIP CAP.	22pF	50V	CH	GRM1882C1H220JA01D	K22174219		1-	A	C5
C 1550	CHIP TA.CAP.	1uF	35V		TEESVA1V105M8R	K78160032		1-	A	I3
C 1551	CHIP TA.CAP.	0.1uF	35V		TEESVA1V104M8R	K78160025		1-	A	I3
C 1552	CHIP CAP.	0.001uF	50V	B	GRM188B11H102KA01D	K22174821		1-	A	D3
C 1553	CHIP CAP.	0.001uF	50V	B	GRM188B11H102KA01D	K22174821		1-	A	D3
C 1554	CHIP CAP.	0.001uF	50V	B	GRM188B11H102KA01D	K22174821		1-	A	D3
C 1555	CHIP CAP.	0.1uF	16V	B	GRM188B11C104KA01D	K22124805		1-	A	D3

TRX Unit

Parts List

REF	DESCRIPTION	VALUE	V/W	TOL.	MFR'S DESIG	VXSTD P/N	VERS.	LOT	SIDE	LAY ADR
C 1556	CHIP CAP.	0.1uF	16V	B	GRM188B11C104KA01D	K22124805		1-	A	D5
C 1557	CHIP CAP.	0.1uF	16V	B	GRM188B11C104KA01D	K22124805		1-	A	G2
C 1558	CHIP CAP.	9pF	50V	CH	GRM1882C1H9R0DZ01D	K22174210		1-	A	C5
C 1559	CHIP CAP.	0.001uF	50V	B	GRM188B11H102KA01D	K22174821		1-	A	F3
C 1560	CHIP CAP.	0.001uF	50V	CH	GRM1882C1H102JA01D	K22174275		1-	A	E6
C 1561	CHIP CAP.	0.001uF	50V	B	GRM188B11H102KA01D	K22174821		1-	A	D5
C 1562	CHIP CAP.	15pF	50V	CH	GRM1882C1H150JA01D	K22174215		1-	A	F3
C 1563	CHIP CAP.	0.01uF	50V	B	GRM188B11H103KA01D	K22174823		1-	A	F3
C 1565	CHIP CAP.	0.01uF	50V	CH	GRM2192C1H103JA01D	K22170291		1-	A	D5
C 1567	CHIP CAP.	0.001uF	50V	B	GRM188B11H102KA01D	K22174821		1-	A	D5
C 1570	CHIP CAP.	7pF	50V	CH	GRM1882C1H7R0DZ01D	K22174208		1-	A	F3
C 1571	CHIP CAP.	0.01uF	50V	B	GRM188B11H103KA01D	K22174823		1-	A	J2
C 1572	CHIP CAP.	0.1uF	16V	B	GRM188B11C104KA01D	K22124805		1-	A	G2
C 1573	CHIP CAP.	0.001uF	50V	B	GRM188B11H102KA01D	K22174821		1-	A	E6
C 1574	CHIP TA.CAP.	2.2uF	16V		TEESVA1C225M8R	K78120015		1-	A	D2
C 1575	AL.ELECTRO.CAP.	47uF	16V		EEE1CA470WR	K48120025		1-	A	I2
C 1576	CHIP TA.CAP.	1uF	35V		TEESVA1V105M8R	K78160032		1-	A	I4
C 1577	CHIP CAP.	0.1uF	16V	B	GRM188B11C104KA01D	K22124805		1-	A	D5
C 1578	CHIP CAP.	0.01uF	50V	B	GRM188B11H103KA01D	K22174823		1-	A	F3
C 1579	CHIP CAP.	0.1uF	16V	B	GRM188B11C104KA01D	K22124805		1-	A	D5
C 1580	AL.ELECTRO.CAP.	47uF	16V		EEE1CA470SP	K48120005		1-	A	D1
C 1581	CHIP CAP.	18pF	50V	CH	GRM1882C1H180JA01D	K22174217		1-	A	C5
C 1582	CHIP CAP.	0.001uF	50V	B	GRM188B11H102KA01D	K22174821		1-	A	J2
C 1583	CHIP CAP.	330pF	50V	CH	GRM1882C1H331JA01D	K22174253		1-	A	I3
C 1584	CHIP CAP.	330pF	50V	CH	GRM1882C1H331JA01D	K22174253		1-	A	I3
C 1585	CHIP CAP.	0.001uF	50V	CH	GRM1882C1H102JA01D	K22174275		1-	A	E6
C 1586	CHIP CAP.	0.1uF	16V	B	GRM188B11C104KA01D	K22124805		1-	A	E6
C 1587	CHIP CAP.	0.01uF	50V	B	GRM188B11H103KA01D	K22174823		1-	A	D4
C 1588	CHIP TA.CAP.	1uF	35V		TEESVA1V105M8R	K78160032		1-	A	C1
C 1589	CHIP CAP.	0.1uF	16V	B	GRM188B11C104KA01D	K22124805		1-	A	F2
C 1590	CHIP TA.CAP.	0.47uF	35V		TEESVA1V474M8R	K78160029		1-	A	H3
C 1592	CHIP CAP.	0.01uF	50V	B	GRM188B11H103KA01D	K22174823		1-	A	C1
C 1593	CHIP TA.CAP.	10uF	16V		TEESVA1C106M8R	K78120077		1-	A	F3
C 1594	CHIP CAP.	0.01uF	50V	B	GRM188B11H103KA01D	K22174823		1-	A	D4
C 1595	CHIP CAP.	0.001uF	50V	B	GRM188B11H102KA01D	K22174821		1-	A	F3
C 1596	CHIP TA.CAP.	1uF	35V		TEESVA1V105M8R	K78160032		1-	A	C1
C 1597	CHIP CAP.	0.001uF	50V	CH	GRM1882C1H102JA01D	K22174275		1-	A	E6
C 1598	CHIP CAP.	0.1uF	16V	B	GRM188B11C104KA01D	K22124805		1-	A	F3
C 1599	CHIP CAP.	0.01uF	50V	B	GRM188B11H103KA01D	K22174823		1-	A	D5
C 1600	CHIP CAP.	0.1uF	16V	B	GRM188B11C104KA01D	K22124805		1-	A	F3
C 1601	CHIP CAP.	0.01uF	50V	B	GRM188B11H103KA01D	K22174823		1-	A	D4
C 1602	CHIP CAP.	0.01uF	50V	B	GRM188B11H103KA01D	K22174823		1-	A	E2
C 1603	CHIP TA.CAP.	1uF	35V		TEESVA1V105M8R	K78160032		1-	A	I3
C 1604	CHIP CAP.	0.001uF	50V	CH	GRM1882C1H102JA01D	K22174275		1-	A	F6
C 1605	CHIP TA.CAP.	10uF	16V		TEESVA1C106M8R	K78120077		1-	A	F3
C 1606	CHIP CAP.	0.01uF	50V	B	GRM188B11H103KA01D	K22174823		1-	A	E6
C 1607	CHIP CAP.	0.01uF	50V	B	GRM188B11H103KA01D	K22174823		1-	A	E3
C 1608	CHIP CAP.	0.01uF	50V	B	GRM188B11H103KA01D	K22174823		1-	A	D3
C 1609	CHIP CAP.	0.1uF	16V	B	GRM188B11C104KA01D	K22124805		1-	A	E2
C 1610	CHIP CAP.	0.001uF	50V	B	GRM188B11H102KA01D	K22174821		1-	A	F2
C 1611	CHIP CAP.	0.01uF	50V	B	GRM188B11H103KA01D	K22174823		1-	A	H3
C 1612	CHIP TA.CAP.	10uF	16V		TEESVA1C106M8R	K78120077		1-	A	E6
C 1613	CHIP CAP.	0.001uF	50V	CH	GRM1882C1H102JA01D	K22174275		1-	A	F6
C 1614	CHIP TA.CAP.	1uF	35V		TEESVA1V105M8R	K78160032		1-	A	F2
C 1615	CHIP CAP.	0.015uF	50V	B	GRM188B11H153KA01D	K22174838		1-	A	J2
C 1616	CHIP CAP.	22pF	50V	CH	GRM1882C1H220JA01D	K22174219		1-	A	E3
C 1617	CHIP CAP.	22pF	50V	CH	GRM1882C1H220JA01D	K22174219		1-	A	D3
C 1618	CHIP TA.CAP.	1uF	35V		TEESVA1V105M8R	K78160032		1-	A	E1
C 1619	CHIP CAP.	0.0015uF	50V	B	GRM188B11H152KA01D	K22174827		1-	A	G2
C 1620	CHIP TA.CAP.	0.1uF	35V		TEESVA1V104M8R	K78160025		1-	A	J2
C 1621	CHIP CAP.	0.01uF	50V	B	GRM188B11H103KA01D	K22174823		1-	A	F2
C 1622	CHIP CAP.	0.1uF	16V	B	GRM188B11C104KA01D	K22124805		1-	A	I3
C 1623	CHIP CAP.	15pF	50V	CH	GRM1882C1H150JA01D	K22174215		1-	A	E3
C 1624	CHIP CAP.	68pF	50V	CH	GRM1882C1H680JA01D	K22174231		1-	A	D3
C 1625	CHIP TA.CAP.	10uF	16V		TEESVA1C106M8R	K78120077		1-	A	G3
C 1626	AL.ELECTRO.CAP.	1000uF	25V		25CE1000BS	K48140025		1-	A	J3
C 1627	CHIP CAP.	0.001uF	50V	B	GRM188B11H102KA01D	K22174821		1-	A	J2
C 1628	CHIP TA.CAP.	1uF	35V		TEESVA1V105M8R	K78160032		1-	A	F2
C 1629	CHIP CAP.	0.1uF	16V	B	GRM188B11C104KA01D	K22124805		1-	A	I3
C 1630	CHIP CAP.	0.01uF	50V	B	GRM188B11H103KA01D	K22174823		1-	A	G2
C 1631	CHIP CAP.	0.1uF	16V	B	GRM188B11C104KA01D	K22124805		1-	A	F3
C 1632	CHIP CAP.	0.01uF	50V	B	GRM188B11H103KA01D	K22174823		1-	A	C5
C 1633	CHIP CAP.	0.1uF	16V	B	GRM188B11C104KA01D	K22124805		1-	A	G3

REF	DESCRIPTION	VALUE	V/W	TOL.	MFR'S DESIG	VXSTD P/N	VERS.	LOT	SIDE	LAY ADR
C 1634	CHIP CAP.	0.01uF	50V	B	GRM188B11H103KA01D	K22174823		1-	A	E2
C 1635	CHIP CAP.	0.01uF	50V	B	GRM188B11H103KA01D	K22174823		1-	A	E2
C 1636	CHIP CAP.	0.01uF	50V	B	GRM188B11H103KA01D	K22174823		1-	A	E1
C 1637	CHIP CAP.	0.01uF	50V	B	GRM188B11H103KA01D	K22174823		1-	A	E2
C 1638	CHIP CAP.	0.01uF	50V	B	GRM188B11H103KA01D	K22174823		1-	A	J3
C 1639	CHIP TA.CAP.	10uF	16V		TEESVA1C106M8R	K78120077		1-	A	F3
C 1640	CHIP TA.CAP.	47uF	16V		TEESVC1C476M12R	K78120057		1-	A	H3
C 1641	CHIP CAP.	0.001uF	50V	B	GRM188B11H102KA01D	K22174821		1-	A	D4
C 1642	CHIP TA.CAP.	10uF	16V		TEESVA1C106M8R	K78120077		1-	A	C5
C 1643	CHIP TA.CAP.	47uF	16V		TEESVC1C476M12R	K78120057		1-	A	I3
C 1644	CHIP CAP.	0.1uF	16V	B	GRM188B11C104KA01D	K22124805		1-	A	F3
C 1645	CHIP CAP.	0.01uF	50V	B	GRM188B11H103KA01D	K22174823		1-	A	F2
C 1646	CHIP CAP.	0.01uF	50V	B	GRM188B11H103KA01D	K22174823		1-	A	C1
C 1647	CHIP TA.CAP.	1uF	35V		TEESVA1V105M8R	K78160032		1-	A	I3
C 1648	CHIP TA.CAP.	1uF	35V		TEESVA1V105M8R	K78160032		1-	A	F1
C 1649	CHIP CAP.	0.01uF	50V	B	GRM188B11H103KA01D	K22174823		1-	A	G3
C 1650	CHIP CAP.	0.1uF	16V	B	GRM188B11C104KA01D	K22124805		1-	A	G3
C 1651	CHIP CAP.	0.01uF	50V	B	GRM188B11H103KA01D	K22174823		1-	A	C1
C 1652	CHIP CAP.	0.01uF	50V	B	GRM188B11H103KA01D	K22174823		1-	A	E3
C 1653	CHIP CAP.	0.1uF	16V	B	GRM188B11C104KA01D	K22124805		1-	A	E2
C 1654	CHIP CAP.	0.01uF	50V	B	GRM188B11H103KA01D	K22174823		1-	A	E3
C 1655	AL.ELECTRO.CAP.	1000uF	25V		25CE1000BS	K48140025		1-	A	I2
C 1656	AL.ELECTRO.CAP.	470uF	16V		16CE470BS	K48120035		1-	A	J2
C 1657	CHIP CAP.	0.1uF	16V	B	GRM188B11C104KA01D	K22124805		1-	A	G3
C 1658	AL.ELECTRO.CAP.	100uF	16V		EEE1CA101WP	K48120012		1-	A	I3
C 1659	CHIP CAP.	0.01uF	50V	B	GRM188B11H103KA01D	K22174823		1-	A	E2
C 1660	CHIP CAP.	2pF	50V	CK	GRM188C1H2R0CZ01D	K22174203		1-	A	D5
C 1661	CHIP CAP.	12pF	50V	CH	GRM1882C1H120JA01D	K22174213		1-	A	E3
C 1662	CHIP CAP.	24pF	50V	CH	GRM1882C1H240JZ01D	K22174220		1-	A	E2
C 1663	CHIP CAP.	12pF	50V	CH	GRM1882C1H120JA01D	K22174213		1-	A	D3
C 1664	CHIP CAP.	0.01uF	50V	B	GRM188B11H103KA01D	K22174823		1-	A	H3
C 1665	CHIP CAP.	0.01uF	50V	B	GRM188B11H103JA01D	K22174824		1-	A	D3
C 1666	CHIP CAP.	0.01uF	50V	B	GRM188B11H103KA01D	K22174823		1-	A	E2
C 1667	CHIP CAP.	0.01uF	50V	B	GRM188B11H103KA01D	K22174823		1-	A	E2
C 1668	CHIP CAP.	0.01uF	50V	B	GRM188B11H103JA01D	K22174824		1-	A	H3
C 1669	CHIP CAP.	0.01uF	50V	B	GRM188B11H103KA01D	K22174823		1-	A	D1
C 1670	CHIP CAP.	0.01uF	50V	B	GRM188B11H103KA01D	K22174823		1-	A	E3
C 1671	CHIP CAP.	120pF	50V	CH	GRM1882C1H121JA01D	K22174237		1-	A	E2
C 1672	CHIP CAP.	0.1uF	16V	B	GRM188B11C104KA01D	K22124805		1-	A	F1
C 1673	CHIP CAP.	0.0015uF	50V	CH	GRM1882C1H152JA01D	K22174277		1-	A	H3
C 1674	CHIP CAP.	0.01uF	50V	B	GRM188B11H103KA01D	K22174823		1-	A	F2
C 1675	AL.ELECTRO.CAP.	47uF	16V		EEE1CA470SP	K48120005		1-	A	F1
C 1676	CHIP CAP.	0.01uF	50V	B	GRM188B11H103KA01D	K22174823		1-	A	D1
C 1677	AL.ELECTRO.CAP.	100uF	16V		EEE1CA101WP	K48120012		1-	A	I3
C 1678	CHIP CAP.	12pF	50V	CH	GRM1882C1H120JA01D	K22174213		1-	A	E3
C 1679	CHIP CAP.	0.1uF	16V	B	GRM188B11C104KA01D	K22124805		1-	A	G3
C 1680	CHIP TA.CAP.	10uF	16V		TEESVA1C106M8R	K78120077		1-	A	D1
C 1681	CHIP CAP.	1uF	16V	B	C1608JB1C105KT	K22124813		1-	A	G1
C 1682	CHIP CAP.	0.1uF	16V	B	GRM188B11C104KA01D	K22124805		1-	A	F1
C 1683	CHIP CAP.	0.027uF	25V	B	GRM188B11E273KA01D	K22144810		1-	A	H3
C 1684	CHIP CAP.	0.01uF	50V	B	GRM188B11H103KA01D	K22174823		1-	A	D2
C 1685	CHIP CAP.	0.01uF	50V	B	GRM188B11H103KA01D	K22174823		1-	A	D1
C 1686	CHIP TA.CAP.	1uF	35V		TEESVA1V105M8R	K78160032		1-	A	G3
C 1687	CHIP CAP.	0.01uF	50V	B	GRM188B11H103KA01D	K22174823		1-	A	J4
C 1688	AL.ELECTRO.CAP.	100uF	16V		EEE1CA101WP	K48120012		1-	A	J3
C 1689	CHIP CAP.	0.01uF	50V	B	GRM188B11H103KA01D	K22174823		1-	A	F2
C 1690	CHIP CAP.	0.01uF	50V	B	GRM188B11H103KA01D	K22174823		1-	A	E1
C 1691	CHIP CAP.	0.1uF	16V	B	GRM188B11C104KA01D	K22124805		1-	A	F2
C 1692	CHIP CAP.	0.1uF	16V	B	GRM188B11C104KA01D	K22124805		1-	A	D2
C 1693	CHIP CAP.	22pF	50V	CH	GRM1882C1H220JA01D	K22174219		1-	A	D4
C 1694	AL.ELECTRO.CAP.	47uF	16V		EEE1CA470SP	K48120005		1-	A	I4
C 1695	CHIP CAP.	0.01uF	50V	B	GRM188B11H103KA01D	K22174823		1-	A	F2
C 1696	CHIP CAP.	33pF	50V	CH	GRM1882C1H330JA01D	K22174223		1-	A	D2
C 1697	CHIP CAP.	0.01uF	50V	B	GRM188B11H103JA01D	K22174824		1-	A	I3
C 1698	CHIP CAP.	10pF	50V	CH	GRM1882C1H100JA01D	K22174211		1-	A	G3
C 1698	CHIP CAP.	100pF	50V	CH	GRM1882C1H101JA01D	K22174235		4-	A	G3
C 1699	CHIP CAP.	0.1uF	16V	B	GRM188B11C104KA01D	K22124805		1-	A	H3
C 1700	CHIP CAP.	0.01uF	50V	B	GRM188B11H103KA01D	K22174823		1-	A	D2
C 1701	CHIP CAP.	0.1uF	16V	B	GRM188B11C104KA01D	K22124805		1-	A	G2
C 1702	CHIP CAP.	0.0082uF	50V	B	GRM188B11H822KA01D	K22174837		1-	A	G3
C 1703	CHIP TA.CAP.	0.1uF	35V		TEESVA1V104M8R	K78160025		1-	A	C5
C 1704	CHIP CAP.	0.1uF	16V	B	GRM188B11C104KA01D	K22124805		1-	A	H3
C 1705	CHIP CAP.	0.01uF	50V	B	GRM188B11H103KA01D	K22174823		1-	A	G2

TRX Unit

Parts List

REF	DESCRIPTION	VALUE	V/W	TOL.	MFR'S DESIG	VXSTD P/N	VERS.	LOT	SIDE	LAY ADR
C 1706	CHIP CAP.	0.01uF	50V	B	GRM188B11H103KA01D	K22174823		1-	A	E4
C 1707	CHIP CAP.	0.01uF	50V	B	GRM188B11H103KA01D	K22174823		1-	A	F2
C 1708	CHIP TA.CAP.	0.47uF	35V		TEESVA1V474M8R	K78160029		1-	A	E2
C 1710	CHIP CAP.	0.01uF	50V	B	GRM188B11H103KA01D	K22174823		1-	A	G1
C 1711	CHIP CAP.	0.01uF	50V	B	GRM188B11H103KA01D	K22174823		1-	A	G2
C 1712	CHIP TA.CAP.	10uF	16V		TEESVA1C106M8R	K78120077		1-	A	G3
C 1713	CHIP CAP.	0.01uF	50V	B	GRM188B11H103KA01D	K22174823		1-	A	G1
C 1714	AL.ELECTRO.CAP.	47uF	16V		EEE1CA470SP	K48120005		1-	A	G3
C 1715	CHIP CAP.	0.01uF	50V	B	GRM188B11H103KA01D	K22174823		1-	A	D2
C 1716	CHIP CAP.	0.1uF	16V	B	GRM188B11C104KA01D	K22124805		1-	A	G2
C 1718	AL.ELECTRO.CAP.	47uF	16V		EEE1CA470SP	K48120005		1-	A	E4
C 1719	CHIP CAP.	22pF	50V	CH	GRM1882C1H220JA01D	K22174219		1-	A	D4
C 1720	CHIP CAP.	0.01uF	50V	B	GRM188B11H103KA01D	K22174823		1-	A	E1
C 1721	CHIP TA.CAP.	1uF	35V		TEESVA1V105M8R	K78160032		1-	A	I3
C 1722	CHIP CAP.	0.1uF	16V	B	GRM188B11C104KA01D	K22124805		1-	A	G3
C 1723	CHIP CAP.	0.1uF	16V	B	GRM188B11C104KA01D	K22124805		1-	A	G2
C 1724	CHIP CAP.	0.01uF	50V	B	GRM188B11H103KA01D	K22174823		1-	A	D4
C 1725	CHIP CAP.	0.01uF	50V	B	GRM188B11H103JA01D	K22174824		1-	A	E2
C 1726	CHIP TA.CAP.	1uF	35V		TEESVA1V105M8R	K78160032		1-	A	F1
C 1727	CHIP CAP.	0.001uF	50V	B	GRM188B11H102KA01D	K22174821		1-	A	F2
C 1729	AL.ELECTRO.CAP.	47uF	16V		EEE1CA470SP	K48120005		1-	A	D4
C 1730	CHIP CAP.	0.001uF	50V	B	GRM188B11H102KA01D	K22174821		1-	A	G3
C 1730	CHIP CAP.	0.0018uF	50V	B	GRM188B11H182KA01D	K22174812		4-	A	G3
C 1732	CHIP CAP.	2pF	50V	CK	GRM1884C1H2ROCZ01D	K22174203		1-	A	E2
C 1733	CHIP CAP.	470pF	50V	CH	GRM1882C1H471JA01D	K22174249		1-	A	D2
C 1734	CHIP CAP.	0.022uF	50V	B	GRM188B11H223KA01D	K22174839		1-	A	I2
C 1735	CHIP CAP.	0.01uF	50V	B	GRM188B11H103KA01D	K22174823		1-	A	J2
C 1736	CHIP CAP.	0.1uF	16V	B	GRM188B11C104KA01D	K22124805		1-	A	H3
C 1737	CHIP CAP.	0.01uF	50V	B	GRM188B11H103KA01D	K22174823		1-	A	D4
C 1738	CHIP CAP.	0.0033uF	50V	B	GRM188B11H332KA01D	K22174831		1-	A	G3
C 1739	CHIP CAP.	0.022uF	50V	B	GRM188B11H223KA01D	K22174839		1-	A	I2
C 1741	CHIP CAP.	0.01uF	50V	B	GRM188B11H103KA01D	K22174823		1-	A	C4
C 1742	CHIP TA.CAP.	1uF	35V		TEESVA1V105M8R	K78160032		1-	A	G2
C 1743	CHIP CAP.	0.1uF	16V	B	GRM188B11C104KA01D	K22124805		1-	A	F1
C 1745	CHIP CAP.	0.01uF	50V	B	GRM188B11H103KA01D	K22174823		1-	A	H2
C 1746	CHIP TA.CAP.	0.22uF	35V		TEESVA1V224M8R	K78160027		1-	A	I3
C 1747	CHIP CAP.	0.022uF	50V	B	GRM188B11H223KA01D	K22174839		1-	A	I2
C 1748	CHIP CAP.	0.01uF	50V	B	GRM188B11H103KA01D	K22174823		1-	A	I2
C 1749	CHIP CAP.	0.0022uF	50V	B	GRM188B11H222KA01D	K22174813		1-	A	H3
C 1750	CHIP CAP.	0.022uF	50V	B	GRM188B11H223KA01D	K22174839		1-	A	I2
C 1752	CHIP CAP.	0.047uF	25V	B	GRM188B11E473KA01D	K22144811		1-	A	I3
C 1753	CHIP CAP.	0.01uF	50V	B	GRM188B11H103JA01D	K22174824		1-	A	D2
C 1754	CHIP CAP.	0.01uF	50V	B	GRM188B11H103KA01D	K22174823		1-	A	D2
C 1755	CHIP CAP.	0.01uF	50V	B	GRM188B11H103KA01D	K22174823		1-	A	J2
C 1756	CHIP CAP.	0.022uF	50V	B	GRM188B11H223KA01D	K22174839		1-	A	I2
C 1757	CHIP CAP.	0.01uF	50V	B	GRM188B11H103KA01D	K22174823		1-	A	I1
C 1758	CHIP CAP.	0.01uF	50V	B	GRM188B11H103KA01D	K22174823		1-	A	I1
C 1759	CHIP TA.CAP.	10uF	16V		TEESVB21C106M8R	K78120025		1-	A	I1
C 1760	CHIP TA.CAP.	10uF	16V		TEESVB21C106M8R	K78120025		1-	A	I1
C 1763	CHIP CAP.	0.01uF	50V	B	GRM188B11H103KA01D	K22174823		1-	A	I4
C 1764	CHIP CAP.	0.01uF	50V	B	GRM188B11H103KA01D	K22174823		1-	A	H3
C 1765	CHIP CAP.	0.001uF	50V	B	GRM188B11H102KA01D	K22174821		1-	A	H3
C 1766	CHIP CAP.	0.001uF	50V	B	GRM188B11H102KA01D	K22174821		1-	A	I3
C 1767	CHIP CAP.	0.1uF	16V	B	GRM188B11C104KA01D	K22124805		1-	A	B4
C 1768	CHIP CAP.	0.1uF	25V	F	GRM188F11E104ZA01D	K22145001		1-	A	H1
C 1769	CHIP CAP.	0.1uF	25V	F	GRM188F11E104ZA01D	K22145001		1-	A	G1
C 1770	CHIP CAP.	1uF	16V	B	C1608JB1C105KT	K22124813		1-	A	H1
C 1772	CHIP CAP.	1uF	16V	B	C1608JB1C105KT	K22124813		1-	A	F5
C 1773	CHIP CAP.	0.01uF	50V	B	GRM188B11H103KA01D	K22174823		1-	A	F5
C 1775	CHIP CAP.	18pF	50V	CH	GRM1882C1H180JA01D	K22174217		1-	A	D4
C 1776	CHIP CAP.	0.001uF	50V	CH	GRM1882C1H102JA01D	K22174275		1-	A	D4
C 1777	CHIP CAP.	0.01uF	50V	B	GRM188B11H103KA01D	K22174823		1-	A	D4
C 1778	CHIP CAP.	0.001uF	50V	B	GRM188B11H102KA01D	K22174821		1-	A	D4
C 1779	CHIP CAP.	0.001uF	50V	B	GRM188B11H102KA01D	K22174821		1-	A	D3
C 1784	CHIP CAP.	0.01uF	50V	B	GRM188B11H103KA01D	K22174823		1-	A	C6
C 1786	CHIP CAP.	0.01uF	50V	B	GRM188B11H103KA01D	K22174823		1-	A	D6
C 1787	CHIP CAP.	0.0033uF	50V	B	GRM188B11H332KA01D	K22174815		1-	A	H3
C 1788	CHIP CAP.	0.01uF	50V	B	GRM188B11H103KA01D	K22174823		1-	A	C6
C 1793	CHIP TA.CAP.	10uF	16V		TEESVA1C106M8R	K78120077		1-	A	I5
C 1794	AL.ELECTRO.CAP.	1000uF	6.3V		ECA0JM102 1000UF	K40089038		1-	A	I4
C 1794	CHIP TA.CAP.	1000uF	4V		TAJD108M004Y	K78060058		4-	A	I4
C 1795	CHIP CAP.	0.22uF	16V	B	GRM188B11C224KA01D	K22124815		1-	A	H3
C 1901	CHIP CAP.	0.022uF	50V	B	GRM188B11H223KA01D	K22174839		1-	A	F5

REF	DESCRIPTION	VALUE	V/W	TOL.	MFR'S DESIG	VXSTD P/N	VERS.	LOT	SIDE	LAY ADR
C 1902	CHIP TA.CAP.	10uF	16V		TEESVA1C106M8R	K78120077		1-	A	F4
C 1903	CHIP CAP.	0.1uF	16V	B	GRM188B11C104KA01D	K22124805		1-	A	F4
C 1904	CHIP TA.CAP.	10uF	16V		TEESVA1C106M8R	K78120077		1-	A	F4
C 1905	CHIP CAP.	0.1uF	16V	B	GRM188B11C104KA01D	K22124805		1-	A	F4
C 1906	CHIP CAP.	5pF	50V	CH	GRM1882C1H5R0CZ01D	K22174206		1-	A	F4
C 1907	CHIP CAP.	0.001uF	50V	CH	GRM1882C1H102JA01D	K22174275		1-	A	F4
C 1908	CHIP CAP.	390pF	50V	CH	GRM1882C1H391JA01D	K22174255		1-	A	F4
C 1909	CHIP CAP.	10pF	50V	CH	GRM1882C1H100JA01D	K22174211		1-	A	F5
C 1910	CHIP CAP.	0.1uF	16V	B	GRM188B11C104KA01D	K22124805		1-	A	F4
C 1911	CHIP CAP.	0.0027uF	50V	CH	GRM1882C1H272JA01D	K22174280		1-	A	G4
C 1912	CHIP CAP.	0.0027uF	50V	CH	GRM1882C1H272JA01D	K22174280		1-	A	G4
C 1913	CHIP CAP.	0.01uF	50V	B	GRM188B11H103KA01D	K22174823		1-	A	F4
C 1914	CHIP TA.CAP.	100uF	16V		TEESVD1C107M12R	K78120059		1-	A	F4
C 1915	CHIP TA.CAP.	10uF	16V		TEESVA1C106M8R	K78120077		1-	A	G4
C 1916	CHIP TA.CAP.	100uF	16V		TEESVD1C107M12R	K78120059		1-	A	G4
C 1917	CHIP CAP.	470pF	50V	CH	GRM1882C1H471JA01D	K22174249		1-	A	F4
C 1918	CHIP TA.CAP.	1uF	35V		TEESVA1V105M8R	K78160032		1-	A	G4
C 1919	CHIP TA.CAP.	2.2uF	25V		TEESVA1E225M8R	K78140020		1-	A	F4
C 1920	AL.ELECTRO.CAP.	100uF	16V		EEE1CA101WP	K48120012		1-	A	F4
C 1921	CHIP CAP.	1uF	16V	B	C1608JB1C105KT	K22124813		1-	A	F3
C 1922	CHIP CAP.	0.015uF	50V	B	GRM188B11H153KA01D	K22174838		1-	A	G3
C 1923	CHIP CAP.	0.01uF	50V	B	GRM188B11H103KA01D	K22174823		1-	A	G3
C 1924	CHIP CAP.	0.022uF	50V	B	GRM188B11H223KA01D	K22174839		1-	A	G3
C 1925	CHIP CAP.	0.022uF	50V	B	GRM188B11H223KA01D	K22174839		1-	A	G3
C 1926	CHIP CAP.	0.022uF	50V	B	GRM188B11H223KA01D	K22174839		1-	A	G3
C 1927	CHIP CAP.	0.022uF	50V	B	GRM188B11H223KA01D	K22174839		1-	A	G3
C 1928	CHIP CAP.	0.015uF	50V	B	GRM188B11H153KA01D	K22174838		1-	A	G3
C 1929	CHIP CAP.	0.01uF	50V	B	GRM188B11H103KA01D	K22174823		1-	A	G3
C 1930	CHIP CAP.	0.1uF	25V	F	GRM188F11E104ZA01D	K22145001		1-	A	F3
C 1931	CHIP CAP.	0.1uF	25V	F	GRM188F11E104ZA01D	K22145001		1-	A	F4
C 1932	AL.ELECTRO.CAP.	47uF	25V		RC2-25V470MF1#	K40149023		1-7	A	J4
C 1932	AL.ELECTRO.CAP.	47uF	16V		EEE1CA470SP	K48120005	W/ CE LABEL	8-	A	J4
C 1932	AL.ELECTRO.CAP.	47uF	25V		RC2-25V470MF1#	K40149023	W/O CE LABEL	8-	A	J4
C 1932	AL.ELECTRO.CAP.	47uF	16V		EEE1CA470SP	K48120005	W/O CE LABEL	11-	A	J4
CF1001	CERAMIC FILTER				CFWLA455KE1Y-B0	H3900581		1-	A	G2
D 1001	SURGE ABSORBER				1608SGX	Q9000891		1-	A	A1
D 1002	DIODE				DAP202U T106	G2070160		1-	A	H1
D 1004	DIODE				DAN202U T106	G2070162		1-	A	B1
D 1005	DIODE				DAP202U T106	G2070160		1-	A	G1
D 1006	DIODE				BAS316	G2070716		1-	A	I6
D 1007	DIODE				BAS316	G2070716		1-	A	I6
D 1008	DIODE				BAS316	G2070716		1-	A	A1
D 1009	DIODE				BAS316	G2070716		1-	A	I1
D 1010	DIODE				1SR154-400 TE25	G2070684		1-	A	H1
D 1011	DIODE				BAS316	G2070716		1-	A	I6
D 1012	DIODE				BAS316	G2070716		1-	A	I1
D 1013	DIODE				BAS316	G2070716		1-	A	A1
D 1014	DIODE				RN142S TE61	G2070994		1-	A	G6
D 1015	DIODE				RN142S TE61	G2070994		1-	A	G5
D 1016	DIODE				RN142S TE61	G2070994		1-	A	G6
D 1017	DIODE				RN142S TE61	G2070994		1-	A	G6
D 1018	DIODE				RN142S TE61	G2070994		1-	A	A2
D 1019	DIODE				RN142S TE61	G2070994		1-	A	A3
D 1020	DIODE				RN142S TE61	G2070994		1-	A	A3
D 1021	DIODE				RN142S TE61	G2070994		1-	A	A4
D 1022	DIODE				BAS316	G2070716		1-	A	B1
D 1023	DIODE				RN142S TE61	G2070994		1-	A	F5
D 1024	DIODE				RN142S TE61	G2070994		1-	A	F6
D 1025	DIODE				RN142S TE61	G2070994		1-	A	F6
D 1026	DIODE				RN142S TE61	G2070994		1-	A	F6
D 1027	DIODE				RN142S TE61	G2070994		1-	A	B2
D 1028	DIODE				RN142S TE61	G2070994		1-	A	B3
D 1029	DIODE				RN142S TE61	G2070994		1-	A	B3
D 1030	DIODE				RN142S TE61	G2070994		1-	A	B4
D 1031	DIODE				RN142S TE61	G2070994		1-	A	A4
D 1032	DIODE				RN142S TE61	G2070994		1-	A	A5
D 1033	DIODE				RN142S TE61	G2070994		1-	A	A5
D 1034	DIODE				BAS316	G2070716		1-	A	C2
D 1035	DIODE				BAS316	G2070716		1-	A	D2
D 1036	DIODE				HZM7.5NB3-TL-E	G2070786		1-	A	H5
D 1037	DIODE				HSB88WS TR-E	G2070290		1-	A	E5
D 1038	DIODE				RN142S TE61	G2070994		1-	A	B4
D 1039	DIODE				RN142S TE61	G2070994		1-	A	B5

TRX Unit

Parts List

REF	DESCRIPTION	VALUE	V/W	TOL.	MFR'S DESIG	VXSTD P/N	VERS.	LOT	SIDE	LAY ADR
D 1040	DIODE				RN142S TE61	G2070994		1-	A	B5
D 1041	DIODE				HZM7.5NB3-TL-E	G2070786		1-	A	G5
D 1042	DIODE				RN142S TE61	G2070994		1-	A	F4
D 1043	DIODE				HZM7.5NB3-TL-E	G2070786		1-	A	G5
D 1044	DIODE				BAS316	G2070716		1-	A	H4
D 1046	DIODE				JDP2S04E(TAPE)	G2071180		1-	A	E4
D 1047	DIODE				BAS316	G2070716		1-	A	A6
D 1048	DIODE				HZM7.5NB3-TL-E	G2070786		1-	A	G5
D 1049	DIODE				BAS316	G2070716		1-	A	G4
D 1050	DIODE				DAN202U T106	G2070162		1-	A	G5
D 1051	DIODE				BAS316	G2070716		1-	A	D2
D 1052	DIODE				DAN202U T106	G2070162		1-	A	G5
D 1053	DIODE				BAS316	G2070716		1-	A	G4
D 1054	DIODE				RN142S TE61	G2070994		1-	A	B6
D 1055	DIODE				DAN202U T106	G2070162		1-	A	D2
D 1056	DIODE				RN142S TE61	G2070994		1-	A	B6
D 1057	DIODE				BAS316	G2070716		1-	A	B6
D 1058	DIODE				BAS316	G2070716		1-	A	D2
D 1059	DIODE				DAP236U T106	G2070592		1-	A	E3
D 1060	DIODE				1SS372(TE85R.F)	G2070632		1-	A	D3
D 1061	DIODE				HSB88ASTR-E	G2071262		1-	A	H2
D 1062	DIODE				HSB88ASTR-E	G2071262		1-	A	H2
D 1063	DIODE				HSM198S TR-E	G2070570		1-	A	E6
D 1064	DIODE				1SS226(TE85R.F)	G2070003		1-	A	F4
D 1065	DIODE				HSB88ASTR-E	G2071262		1-	A	H2
D 1066	DIODE				HSB88ASTR-E	G2071262		1-	A	H2
D 1067	DIODE				BAS316	G2070716		1-	A	D2
D 1068	DIODE				DAP236U T106	G2070592		1-	A	E3
D 1069	DIODE				BAS316	G2070716		1-	A	H3
D 1070	DIODE				JDP2S04E(TAPE)	G2071180		1-	A	F6
D 1071	DIODE				JDP2S04E(TAPE)	G2071180		1-	A	F6
D 1072	DIODE				JDP2S04E(TAPE)	G2071180		1-	A	F6
D 1073	DIODE				RN142S TE61	G2070994		1-	A	E3
D 1074	DIODE				RN142S TE61	G2070994		1-	A	E3
D 1075	DIODE				RN142S TE61	G2070994		1-	A	D3
D 1076	DIODE				BAS316	G2070716		1-	A	C4
D 1077	DIODE				DAP202U T106	G2070160		1-	A	F2
D 1078	DIODE				BAS316	G2070716		1-	A	G1
D 1079	DIODE				BAS316	G2070716		1-	A	D1
D 1080	DIODE				DAP202U T106	G2070160		1-	A	F2
D 1081	DIODE				DAP202U T106	G2070160		1-	A	G2
D 1082	DIODE				BAS316	G2070716		1-	A	D1
D 1083	DIODE				RN142S TE61	G2070994		1-	A	E3
D 1084	DIODE				RN142S TE61	G2070994		1-	A	E2
D 1085	DIODE				RN142S TE61	G2070994		1-	A	D2
D 1086	DIODE				BAS316	G2070716		1-	A	J4
D 1087	DIODE				RN142S TE61	G2070994		1-	A	D4
D 1089	DIODE				BAS316	G2070716		1-	A	G1
D 1090	DIODE				BAS316	G2070716		1-	A	E1
D 1091	DIODE				RN142S TE61	G2070994		1-	A	D4
D 1092	DIODE				BAS316	G2070716		1-	A	G1
D 1093	DIODE				DAP202U T106	G2070160		1-	A	G2
D 1095	DIODE				JDP2S04E(TAPE)	G2071180		1-	A	E2
D 1096	DIODE				BAS316	G2070716		1-	A	G1
D 1097	DIODE				BAS316	G2070716		1-	A	G1
D 1098	DIODE				BAS316	G2070716		1-	A	J4
D 1099	DIODE				BAS316	G2070716		1-	A	G1
D 1100	DIODE				BAS316	G2070716		1-	A	E5
D 1101	DIODE				BAS316	G2070716		1-	A	E5
D 1102	DIODE				BAS316	G2070716		1-	A	F5
D 1103	DIODE				BAS316	G2070716		1-	A	F5
D 1104	DIODE				RN142S TE61	G2070994		1-	A	F5
D 1105	DIODE				UDZS TE-17 6.8B	G2070888		1-	A	D5
D 1901	DIODE				BAS316	G2070716		1-	A	F4
FB1001	FERRITE BEADS				BLM18BD182SN1D	L1690602		1-	A	I4
FB1002	FERRITE BEADS				BLM18BD182SN1D	L1690602		1-	A	J4
FB1003	FERRITE BEADS				BLM18BD182SN1D	L1690602		1-15	A	I4
FB1004	FERRITE BEADS				BLM18BD182SN1D	L1690602		1-	A	J4
FB1005	FERRITE BEADS				BLM18BD182SN1D	L1690602		1-	A	J4
FB1006	FERRITE BEADS				BLM18BD182SN1D	L1690602		1-	A	J4
FB1007	FERRITE BEADS				BLM18BD182SN1D	L1690602		1-	A	J4
FB1008	FERRITE BEADS				BLM18BD182SN1D	L1690602		1-	A	J4
FB1009	FERRITE BEADS				BLM18BD182SN1D	L1690602		1-	A	J4

REF	DESCRIPTION	VALUE	V/W	TOL.	MFR'S DESIG	VXSTD P/N	VERS.	LOT	SIDE	LAY ADR
FB1010	FERRITE BEADS				BLM18BD182SN1D	L1690602		1-	A	J4
FB1011	FERRITE BEADS				BLM18BD182SN1D	L1690602		1-	A	J4
FB1014	FERRITE BEADS				BLM18BD182SN1D	L1690602		1-	A	J5
FB1015	FERRITE BEADS				BLM18BD182SN1D	L1690602		1-	A	J5
FB1016	FERRITE BEADS				BLM18BD182SN1D	L1690602		1-	A	H1
FB1017	FERRITE BEADS				BLM18BD182SN1D	L1690602		1-	A	I5
FB1017	CHIP RES.	0	1/16W	5%	RMC1/16 000JATP	J24185000		5-	A	I5
FB1018	FERRITE BEADS				BLM18BD182SN1D	L1690602		1-	A	I5
FB1018	CHIP RES.	220	1/16W	5%	RMC1/16 221JATP	J24185221		5-	A	I5
J 1001	CONNECTOR				TMP-J01X-V6	P1090210		1-	A	A1
J 1002	CONNECTOR				TMP-J01X-V6	P1090210		1-	A	J6
J 1003	CONNECTOR				LPR6520-3502F	P1091297		1-7		
J 1003	CONNECTOR				LPR6520-3502F	P1091297	W/O CE LABEL	8-10		
J 1007	CONNECTOR				30FLT-SM2-TB(LF)(SN)(M)	P1091142		1-	A	J4
J 1009	CONNECTOR				TCS4690-0141577	P1091143		1-	A	B1
J 1010	CONNECTOR				M50006020-IIBA R41-9553D	P1090925		1-	A	A1
J 1011	CONNECTOR				IMSA6065B-03-Z075-PT1	P0091454		1-	A	B4
J 1012	CONNECTOR				IMSA6065B-06-Z075-PT1	P0091455		1-	A	B2
J 1013	CONNECTOR				IMSA6065B-05-Z075-PT1	P0091416		1-	A	C3
J 1014	TERMINAL				P07	Q5000166		1-	A	A2
J 1015	TERMINAL				P07	Q5000166		1-	A	A4
J 1016	TERMINAL				P07	Q5000166		1-	A	A2
J 1017	TERMINAL				P07	Q5000166		1-	A	C2
J 1018	CONNECTOR				30FLT-SM2-TB(LF)(SN)(M)	P1091142		1-	A	J5
J 1019	CONNECTOR				IMSA6065B-06-Z075-PT1	P0091455		1-	A	G3
J 1020	CONNECTOR				SC25-03WS	P0090622		1-	A	G5
J 1021	TERMINAL				P07	Q5000166		1-	A	F3
J 1022	TERMINAL				P07	Q5000166		1-	A	F5
J 1023	CONNECTOR				IMSA6065B-06-Z075-PT1	P0091455		1-	A	J6
J 1024	CONNECTOR				IMSA6065B-05-Z075-PT1	P0091416		1-	A	G5
J 1025	CONNECTOR				IMSA6065B-05-Z075-PT1	P0091416		1-	A	H5
J 1026	CONNECTOR				SB20-02WS	P0090609		1-	A	I5
J 1027	CONNECTOR				YKB21-5144	P1091234		1-	A	E1
J 1028	CONNECTOR				SB20-05WS	P0090612		1-	A	I3
J 1029	CONNECTOR				SB20-04WS	P0090611		1-	A	I4
J 1030	CONNECTOR				TCS4650-0141577	P1090635		1-	A	C1
J 1031	CONNECTOR				TCS4640-01-4151	P1090634		1-	A	D1
J 1032	CONNECTOR				SB20-04WS	P0090611		1-	A	H3
J 1033	CONNECTOR				SB20-05WS	P0090612		1-	A	I2
J 1034	CONNECTOR				SC25-02WS	P0090621		1-	A	G1
J 1035	CONNECTOR				SB20-05WS	P0090612		1-	A	I3
J 1036	CONNECTOR				SB20-06WS	P0090613		1-	A	I2
J 1037	CONNECTOR				SB20-06WS	P0090613		1-	A	I2
J 1038	CONNECTOR				YKB21-5296N	P1091233		1-	A	F1
J 1039	CONNECTOR				HLJ2305-0130609	P1090823		1-	A	J1
J 1040	CONNECTOR				TMP-J01X-V6	P1090210		1-	A	F6
J 1041	CONNECTOR				TMP-J01X-V6	P1090210		1-	A	F2
J 1042	CONNECTOR				TMP-J01X-V6	P1090210		1-	A	H2
J 1043	CONNECTOR				TMP-J01X-V6	P1090210		1-	A	F4
J 1046	CONNECTOR				TMP-J01X-V6	P1090210		1-	A	B1
J 1047	CONNECTOR				TMP-J01X-V6	P1090210		1-	A	B4
J 1048	TERMINAL				P07	Q5000166		1-	A	H3
J 1049	TERMINAL				P07	Q5000166		1-	A	H5
J 1050	CONNECTOR				TMP-J01X-V6	P1090210		1-	A	H1
J 1051	CONNECTOR				TMP-J01X-V6	P1090210		1-	A	I6
J 1052	CONNECTOR				HSJ0917-0101408	P1090852		1-	A	F1
J 1053	CONNECTOR				LPR6520-8T30FM	P1091423	W/ CE LABEL	8-	A	H1
J 1053	CONNECTOR				LPR6520-8T30FM	P1091423	W/O CE LABEL	11-	A	H1
J 1054	CONNECTOR				LPR6520-8T30FM	P1091423	W/ CE LABEL	8-	A	I1
J 1054	CONNECTOR				LPR6520-8T30FM	P1091423	W/O CE LABEL	11-	A	I1
JP1001	WIRE ASSY				WHT 90 */*	T9317967		1-		
JP1002	WIRE ASSY				GRN 20 2/2	T50502000		1-7		
JP1002	WIRE ASSY				GRN 20 2/2	T50502000	W/O CE LABEL	8-10		
JP1003	WIRE AWG40-0.21PFA				GRN 40(2)/(2)	T9318338		1-7		
JP1003	WIRE AWG40-0.21PFA				GRN 40(2)/(2)	T9318338	W/O CE LABEL	8-10		
L 1002	M.RFC	1000uH			LLM3225-102J	L1691157		1-	A	H1
L 1003	CHIP COIL	0.68uH		2%	C2520C-R68G-RA	L1691305		1-	A	J6
L 1005	M.RFC	1000uH		5%	EL0606RA-102J-PF	L1790300		1-	A	A1
L 1006	M.RFC	100uH			LLM3225-101J	L1691145		1-	A	H1
L 1007	M.RFC	100uH			LLM3225-101J	L1691145		1-	A	H1
L 1008	CHIP COIL	0.1uH		2%	C2520C-R10G-RA	L1691294		1-	A	I6
L 1011	CHIP COIL	0.15uH		2%	C2520C-R15G-RA	L1691296		1-	A	I6
L 1012	CHIP COIL	0.15uH		2%	C2520C-R15G-RA	L1691296		1-	A	I6

TRX Unit

Parts List

REF	DESCRIPTION	VALUE	V/W	TOL.	MFR'S DESIG	VXSTD P/N	VERS.	LOT	SIDE	LAY ADR
L 1013	M.RFC	100uH			LLM3225-101J	L1691145		1-	A	C1
L 1014	M.RFC	10uH			LLM3225-100J	L1691133		1-	A	I6
L 1016	M.RFC	1mH			LAL03TA102K	L1790119		1-	A	B2
L 1017	CHIP COIL	10uH		5%	NLV-25T-100J-PF	L1691436		1-	A	G5
L 1018	CHIP COIL	0.82uH		5%	NLV-25T-R82J-PF	L1691423		1-	A	G6
L 1019	CHIP COIL	0.33uH		5%	NLV-25T-R33J-PF	L1691418		1-	A	G6
L 1020	CHIP COIL	0.047uH		5%	NLV-25T-047J-PF	L1691408		1-	A	G6
L 1021	CHIP COIL	1uH		2%	C2520C-1R0G-RA	L1691309		1-	A	A2
L 1022	CHIP COIL	0.22uH		2%	C2520C-R22G-RA	L1691298		1-	A	A3
L 1023	CHIP COIL	0.39uH		2%	C2520C-R39G-RA	L1691301		1-	A	A3
L 1024	CHIP COIL	0.68uH		2%	C2520C-R68G-RA	L1691305		1-	A	A4
L 1025	CHIP COIL	1.2uH		5%	NLV-25T-1R2J-PF	L1691425		1-	A	G5
L 1026	CHIP COIL	1uH		5%	NLV-25T-1R0J-PF	L1691424		1-	A	G6
L 1027	CHIP COIL	1uH		5%	NLV-25T-1R0J-PF	L1691424		1-	A	G6
L 1028	CHIP COIL	0.68uH		5%	NLV-25T-R68J-PF	L1691422		1-	A	G6
L 1029	CHIP COIL	0.56uH		2%	C2520C-R56G-RA	L1691303		1-	A	A3
L 1030	CHIP COIL	0.68uH		2%	C2520C-R68G-RA	L1691305		1-	A	A3
L 1031	CHIP COIL	0.82uH		2%	C2520C-R82G-RA	L1691307		1-	A	A4
L 1032	CHIP COIL	3.3uH		5%	NLV-25T-3R3J-PF	L1691430		1-	A	G5
L 1033	CHIP COIL	0.27uH		5%	NLV-25T-R27J-PF	L1691417		1-	A	G6
L 1034	CHIP COIL	0.1uH		5%	NLV-25T-R10J-PF	L1691412		1-	A	G6
L 1035	CHIP COIL	0.022uH		5%	NLV-25T-022J-PF	L1691404		1-	A	G6
L 1036	M.RFC	0.11uH		2%	C6342A-R11G-RA	L1691087		1-	A	A2
L 1037	M.RFC	0.18uH			LAN02TAR18K	L1790169		1-	A	B1
L 1038	M.RFC	0.067uH		2%	C6342A-67NG-RA	L1691085		1-	A	B3
L 1039	M.RFC	0.13uH		2%	C6342A-R13G-RA	L1691088		1-	A	B3
L 1040	CHIP COIL	0.22uH		2%	C2520C-R22G-RA	L1691298		1-	A	B4
L 1041	CHIP COIL	1.2uH		5%	NLV-25T-1R2J-PF	L1691425		1-	A	F5
L 1042	CHIP COIL	1uH		5%	NLV-25T-1R0J-PF	L1691424		1-	A	F6
L 1043	CHIP COIL	1uH		5%	NLV-25T-1R0J-PF	L1691424		1-	A	F6
L 1044	CHIP COIL	0.68uH		5%	NLV-25T-R68J-PF	L1691422		1-	A	F6
L 1045	CHIP COIL	0.56uH		2%	C2520C-R56G-RA	L1691303		1-	A	B3
L 1046	CHIP COIL	0.68uH		2%	C2520C-R68G-RA	L1691305		1-	A	B3
L 1047	CHIP COIL	0.82uH		2%	C2520C-R82G-RA	L1691307		1-	A	B4
L 1048	M.RFC	4.7uH			LAN02TA4R7J	L1790186		1-	A	B2
L 1049	M.RFC	0.22uH			LAN02TAR22K	L1790170		1-	A	B1
L 1050	M.RFC	0.11uH		2%	C6342A-R11G-RA	L1691087		1-	A	B2
L 1051	M.RFC	3.9uH			LAN02TA3R9J	L1790185		1-	A	B2
L 1052	M.RFC	0.18uH			LAN02TAR18K	L1790169		1-	A	B1
L 1053	M.RFC	3.9uH			LAN02TA3R9J	L1790185		1-	A	B2
L 1054	CHIP COIL	10uH		5%	NLV-25T-100J-PF	L1691436		1-	A	F5
L 1055	CHIP COIL	0.82uH		5%	NLV-25T-R82J-PF	L1691423		1-	A	F6
L 1056	CHIP COIL	0.33uH		5%	NLV-25T-R33J-PF	L1691418		1-	A	F6
L 1057	CHIP COIL	0.047uH		5%	NLV-25T-047J-PF	L1691408		1-	A	F6
L 1058	CHIP COIL	1uH		2%	C2520C-1R0G-RA	L1691309		1-	A	B2
L 1059	CHIP COIL	0.22uH		2%	C2520C-R22G-RA	L1691298		1-	A	B3
L 1060	CHIP COIL	0.39uH		2%	C2520C-R39G-RA	L1691301		1-	A	B3
L 1061	CHIP COIL	0.68uH		2%	C2520C-R68G-RA	L1691305		1-	A	B4
L 1062	M.RFC	4.7uH			LAN02TA4R7J	L1790186		1-	A	B2
L 1063	M.RFC	1.2uH		5%	EL0606RA-1R2J-PF	L1790265		1-	A	A4
L 1064	M.RFC	2.7uH		5%	EL0606RA-2R7J-PF	L1790269		1-	A	A5
L 1065	M.RFC	5.6uH		5%	EL0606RA-5R6J-PF	L1790273		1-	A	A5
L 1066	M.RFC	1.5uH		5%	EL0606RA-1R5J-PF	L1790266		1-	A	A4
L 1067	M.RFC	2.7uH		5%	EL0606RA-2R7J-PF	L1790269		1-	A	A5
L 1068	M.RFC	5.6uH		5%	EL0606RA-5R6J-PF	L1790273		1-	A	A5
L 1069	M.RFC	6.8uH			LAP02TA6R8K	L1790056		1-	A	B3
L 1070	M.RFC	0.39uH		10%	EL0606RA-R39K-PF	L1790259		1-	A	A4
L 1071	M.RFC	1uH		5%	EL0606RA-1R0J-PF	L1790264		1-	A	A5
L 1072	M.RFC	1.8uH		5%	EL0606RA-1R8J-PF	L1790267		1-	A	A5
L 1073	M.RFC	0.22uH		5%	C2012C-R22J	L1690796		1-	A	E5
L 1074	M.RFC	8.2uH			LAP02TA8R2K	L1790057		1-	A	B3
L 1075	M.RFC	1.5uH		5%	EL0606RA-1R5J-PF	L1790266		1-	A	A4
L 1076	M.RFC	2.7uH		5%	EL0606RA-2R7J-PF	L1790269		1-	A	A5
L 1077	M.RFC	5.6uH		5%	EL0606RA-5R6J-PF	L1790273		1-	A	A5
L 1078	M.RFC	6.8uH			LAP02TA6R8K	L1790056		1-	A	B3
L 1079	CHIP COIL	0.15uH		2%	C2520C-R15G-RA	L1691296		1-	A	E5
L 1080	M.RFC	1uH			LK1608 1R0K-T	L1690687		1-	A	E4
L 1081	M.RFC	1.2uH		5%	EL0606RA-1R2J-PF	L1790265		1-	A	B4
L 1082	M.RFC	2.7uH		5%	EL0606RA-2R7J-PF	L1790269		1-	A	B5
L 1083	M.RFC	5.6uH		5%	EL0606RA-5R6J-PF	L1790273		1-	A	B5
L 1084	M.RFC	1mH			LAL03TA102K	L1790119		1-	A	C4
L 1085	CHIP COIL	0.15uH		2%	C2520C-R15G-RA	L1691296		1-	A	E5
L 1086	M.RFC	1mH			LAL03TA102K	L1790119		1-	A	A2

REF	DESCRIPTION	VALUE	V/W	TOL.	MFR'S DESIG	VXSTD P/N	VERS.	LOT	SIDE	LAY ADR
L 1087	M.RFC	47uH			LLM3225-470J	L1691141		1-	A	B6
L 1088	CHIP COIL	2.2uH		2%	C2520C-2R2G-RA	L1691313		1-	A	E5
L 1089	M.RFC	470uH			LLM3225-471J	L1691153		1-	A	G1
L 1090	M.RFC	47uH			LLM3225-470J	L1691141		1-	A	A6
L 1091	M.RFC	1000uH		5%	EL0606RA-102J-PF	L1790300		1-	A	C6
L 1092	CHIP COIL	0.15uH		2%	C2520C-R15G-RA	L1691296		1-	A	D6
L 1093	CHIP COIL	0.15uH		2%	C2520C-R15G-RA	L1691296		1-	A	D6
L 1094	CHIP COIL	0.15uH		2%	C2520C-R15G-RA	L1691296		1-	A	D6
L 1095	M.RFC	1000uH		5%	EL0606RA-102J-PF	L1790300		1-	A	H2
L 1096	CHIP COIL	0.1uH		2%	C2520C-R10G-RA	L1691294		1-	A	E6
L 1097	CHIP COIL	0.1uH		2%	C2520C-R10G-RA	L1691294		1-	A	E6
L 1098	M.RFC	47uH			LLM3225-470J	L1691141		1-	A	D5
L 1100	CHIP COIL	2.2uH		10%	C2520C-2R2K-RK	L1690731		1-	A	F3
L 1101	CHIP COIL	4.7uH		2%	C2520C-4R7G-RA	L1691317		1-	A	F6
L 1102	M.RFC	82uH			LLM3225-820J	L1691144		1-	A	G2
L 1103	CHIP COIL	1mH			LQH43MN102K03L	L1690108		1-	A	F2
L 1104	M.RFC	470uH			LLM3225-471J	L1691153		1-	A	C1
L 1105	M.RFC	470uH			LLM3225-471J	L1691153		1-	A	C1
L 1106	CHIP COIL	1mH			LQH43MN102K03L	L1690108		1-	A	F1
L 1107	COIL 07RF	40.455MHz			M7-T1 R-12W084A	L0022921		1-	A	E2
L 1108	M.RFC	470uH			LLM3225-471J	L1691153		1-	A	C1
L 1109	M.RFC	470uH			LLM3225-471J	L1691153		1-	A	D1
L 1110	M.RFC	470uH			LLM3225-471J	L1691153		1-	A	D1
L 1111	M.RFC	470uH			LLM3225-471J	L1691153		1-	A	E1
L 1112	M.RFC	15uH			LLM3225-150J	L1691135		1-	A	D2
L 1113	M.RFC	470uH			LLM3225-471J	L1691153		1-	A	E1
L 1114	CHIP COIL	1mH			LQH43MN102K03L	L1690108		1-	A	G2
L 1115	CHIP COIL	1mH			LQH43MN102K03L	L1690108		1-	A	H1
L 1901	M.RFC	470uH			FLC32T-471J	L1690235		1-	A	F4
L 1902	M.RFC	56uH			FLC32T-560J	L1690224		1-	A	F3
L 1903	M.RFC	68uH			FLC32T-680J	L1690225		1-	A	F3
L 1904	M.RFC	56uH			FLC32T-560J	L1690224		1-	A	F3
L 1905	CHIP COIL	1mH			LQH43MN102K03L	L1690108		1-	A	F3
Q 1001	POLY SWITCH				MINISMDC110F/16	G9090182	W/ CE LABEL	1-	A	I1
Q 1001	POLY SWITCH				MINISMDC150F/16	G9090183	W/ CE LABEL	8-	A	I1
Q 1001	POLY SWITCH				MINISMDC075F/24	G9090180	W/O CE LABEL	1-	A	I1
Q 1001	POLY SWITCH				MINISMDC110F/16	G9090182	W/O CE LABEL	13-	A	I1
Q 1002	TRANSISTOR				DTC114EUA T106	G3070084		1-	A	I6
Q 1003	IC				LM2904PWR	G1094010		1-	A	G6
Q 1004	TRANSISTOR				DTA114EUA T106	G3070083		1-	A	A1
Q 1005	FET				3SK131-T2B V12	G4801317B		1-	A	H6
Q 1006	IC				BU2152FS(TAPE)	G1093942		1-	A	I5
Q 1007	TRANSISTOR				DTC114YUA T106	G3070298		1-	A	I5
Q 1008	TRANSISTOR				DTC114EUA T106	G3070084		1-	A	H6
Q 1008	TRANSISTOR				GA4L4K-T1-A/JM	G3070443		16-	A	H6
Q 1009	IC				LM2904PWR	G1094010		1-	A	H1
Q 1010	TRANSISTOR				DTC114YUA T106	G3070298		1-	A	I5
Q 1011	TRANSISTOR				2SC5415E-TD-E	G3354158E		1-	A	H6
Q 1012	TRANSISTOR				2SD2403GY-T1	G3424038Y		1-	A	H1
Q 1013	TRANSISTOR				DTA114EUA T106	G3070083		1-	A	A1
Q 1014	TRANSISTOR				DTC114EUA T106	G3070084		1-	A	I1
Q 1015	IC				SN74HCT04PWR	G1094484		1-	A	I4
Q 1016	TRANSISTOR				DTA114EUA T106	G3070083		1-	A	B1
Q 1017	IC				LM2904PWR	G1094010		1-	A	D1
Q 1018	IC				BU2152FS(TAPE)	G1093942		1-	A	C4
Q 1019	IC				BU2505FV-E2	G1093714		1-	A	H4
Q 1020	TRANSISTOR				DTA114EUA T106	G3070083		1-	A	C2
Q 1021	IC				NJM2068V-TE1	G1094112		1-	A	H5
Q 1022	IC				NJM2068V-TE1	G1094112		1-	A	G5
Q 1023	IC				NJM2737V(TAPE)	G1094292		1-	A	G3
Q 1024	TRANSISTOR				DTC143ZE TL	G3070102		1-	A	C6
Q 1025	FET				SST310-T1	G4070009		1-	A	E4
Q 1026	TRANSISTOR				2SC4081 T106 R	G3340818R		1-	A	G3
Q 1027	IC				NJM2737V(TAPE)	G1094292		1-	A	I5
Q 1028	TRANSISTOR				2SC3357-T2 RF	G3333577F		1-	A	B6
Q 1029	IC				NJM2068V-TE1	G1094112		1-	A	G5
Q 1030	TRANSISTOR				DTC143ZE TL	G3070102		1-	A	C4
Q 1031	FET				SST310-T1	G4070009		1-	A	E4
Q 1032	TRANSISTOR				DTC143ZE TL	G3070102		1-	A	C4
Q 1033	TRANSISTOR				2SC4081 T106 R	G3340818R		1-	A	D2
Q 1034	IC				NJM2068V-TE1	G1094112		1-	A	I2
Q 1035	TRANSISTOR				DTC143ZE TL	G3070102		1-	A	C4
Q 1036	TRANSISTOR				2SC4081 T106 R	G3340818R		1-	A	D2

TRX Unit

Parts List

REF	DESCRIPTION	VALUE	V/W	TOL.	MFR'S DESIG	VXSTD P/N	VERS.	LOT	SIDE	LAY ADR
Q 1037	TRANSISTOR				2SC3357-T2 RF	G3333577F		1-	A	A6
Q 1038	IC				LM2902PWR	G1094009		1-	A	G4
Q 1039	TRANSISTOR				2SC4081 T106 R	G3340818R		1-	A	E4
Q 1040	TRANSISTOR				DTC143ZE TL	G3070102		1-	A	C5
Q 1041	TRANSISTOR				DTC143ZE TL	G3070102		1-	A	C4
Q 1042	FET				BF1201WR_115	G3070425		1-	A	E4
Q 1043	TRANSISTOR				2SC4081 T106 R	G3340818R		1-	A	I5
Q 1043	TRANSISTOR				2SC4116GR(TE85L.F)	G3341168G		4-	A	I5
Q 1044	TRANSISTOR				2SA1576A T106 R	G3115768R		1-	A	D2
Q 1045	TRANSISTOR				2SC4081 T106 R	G3340818R		1-	A	G5
Q 1046	TRANSISTOR				DTC143ZE TL	G3070102		1-	A	C4
Q 1047	IC				M51132FP 600C	G1091930		1-	A	H4
Q 1048	TRANSISTOR				DTC143ZE TL	G3070102		1-	A	C4
Q 1049	TRANSISTOR				DTC144EUA T106	G3070041		1-	A	E3
Q 1050	IC				NJM2068V-TE1	G1094112		1-	A	G5
Q 1051	TRANSISTOR				2SA1576A T106 R	G3115768R		1-	A	D2
Q 1052	TRANSISTOR				DTC143ZE TL	G3070102		1-	A	C4
Q 1053	TRANSISTOR				DTC143ZE TL	G3070102		1-	A	B4
Q 1054	TRANSISTOR				2SC4081 T106 R	G3340818R		1-	A	D3
Q 1055	IC				SN74LVC2G66DCTR	G1094049		1-	A	D2
Q 1056	TRANSISTOR				DTC143ZE TL	G3070102		1-	A	C4
Q 1057	IC				CD74HCT4053PWR	G1094273		1-	A	H4
Q 1058	TRANSISTOR				DTC143ZE TL	G3070102		1-	A	C4
Q 1059	TRANSISTOR				UMD5N TR	G3070343		1-	A	B5
Q 1060	TRANSISTOR				DTC143ZE TL	G3070102		1-	A	C4
Q 1061	FET				3SK294(TE85L)	G4802948		1-	A	C6
Q 1062	FET				3SK294(TE85L)	G4802948		1-	A	C6
Q 1063	FET				3SK294(TE85L)	G4802948		1-	A	C6
Q 1064	FET				3SK294(TE85L)	G4802948		1-	A	C6
Q 1065	TRANSISTOR				UMD5N TR	G3070343		1-	A	B5
Q 1066	TRANSISTOR				DTC143ZE TL	G3070102		1-	A	C4
Q 1067	TRANSISTOR				DTC144EUA T106	G3070041		1-	A	F3
Q 1068	IC				LM2904PWR	G1094010		1-	A	E6
Q 1069	TRANSISTOR				2SC4081 T106 R	G3340818R		1-	A	D2
Q 1070	TRANSISTOR				DTC114EUA T106	G3070084		1-	A	G3
Q 1071	IC				CD74HCT4053PWR	G1094273		1-	A	I4
Q 1072	IC				M62364FP 600D	G1093033		1-	A	I4
Q 1073	TRANSISTOR				2SC2714Y(TE85R.F)	G3327147Y		1-	A	F4
Q 1074	TRANSISTOR				DTC143ZE TL	G3070102		1-	A	C4
Q 1075	IC				NJM2737V(TAPE)	G1094292		1-	A	H3
Q 1076	TRANSISTOR				DTC143ZE TL	G3070102		1-	A	C5
Q 1077	IC				UPC3231GV-E1-A	G1094685		1-	A	D3
Q 1078	TRANSISTOR				2SC4081 T106 R	G3340818R		1-	A	E6
Q 1079	TRANSISTOR				DTC143ZE TL	G3070102		1-	A	C4
Q 1080	TRANSISTOR				DTC143ZE TL	G3070102		1-	A	C5
Q 1081	TRANSISTOR				2SC3357-T2 RF	G3333577F		1-	A	D5
Q 1082	FET				2SK209GR TE85R	G3802097G		1-	A	H3
Q 1082	FET				2SK209GR(TE85L.F)	G3802098G		16-	A	H3
Q 1083	IC				NJM2737V(TAPE)	G1094292		1-	A	I3
Q 1084	TRANSISTOR				DTC143ZE TL	G3070102		1-	A	C4
Q 1085	FET				SST310-T1	G4070009		1-	A	F3
Q 1086	TRANSISTOR				DTC143ZE TL	G3070102		1-	A	C5
Q 1087	TRANSISTOR				2SC5415E-TD-E	G3354158E		1-	A	E6
Q 1088	TRANSISTOR				DTC114EUA T106	G3070084		1	A	G2
Q 1088	TRANSISTOR				GA4L4K-T1-A/JM	G3070443		2-	A	G2
Q 1089	IC				CD74HCT4053PWR	G1094273		1-	A	H3
Q 1090	FET				BF1201WR_115	G3070425		1-	A	D4
Q 1091	IC				NJM2737V(TAPE)	G1094292		1-	A	J2
Q 1092	IC				CD74HCT4053PWR	G1094273		1-	A	I3
Q 1093	IC				SN74LVC2G66DCTR	G1094049		1-	A	I3
Q 1094	IC				NJM2594V-TE1	G1093750		1-	A	F3
Q 1095	IC				TA75S01F(TE85R.F)	G1091593		1-	A	D4
Q 1096	TRANSISTOR				DTC114EUA T106	G3070084		1-	A	G2
Q 1097	FET				SST310-T1	G4070009		1-	A	E2
Q 1098	FET				SST310-T1	G4070009		1-	A	E2
Q 1099	FET				SST310-T1	G4070009		1-	A	E1
Q 1100	FET				SST310-T1	G4070009		1-	A	E2
Q 1101	IC				LA4425A-E	G1092241		1-	A	J2
Q 1102	TRANSISTOR				2SC4081 T106 R	G3340818R		1-	A	F2
Q 1103	IC				NJM2594V-TE1	G1093750		1-	A	G3
Q 1104	TRANSISTOR				DTC114EUA T106	G3070084		1-	A	F1
Q 1105	IC				NJM2768BRB1-TE1	G1094674		1-	A	I3
Q 1106	IC				LM2904PWR	G1094010		1-	A	D1

REF	DESCRIPTION	VALUE	V/W	TOL.	MFR'S DESIG	VXSTD P/N	VERS.	LOT	SIDE	LAY ADR
Q 1107	TRANSISTOR				2SA1576A T106 R	G3115768R		1-	A	G1
Q 1108	TRANSISTOR				2SC4081 T106 R	G3340818R		1-	A	G1
Q 1109	IC				NJM2737V(TAPE)	G1094292		1-	A	H3
Q 1110	TRANSISTOR				2SC4081 T106 R	G3340818R		1-	A	G1
Q 1111	IC				NJM2737V(TAPE)	G1094292		1-	A	G3
Q 1112	TRANSISTOR				UMD5N TR	G3070343		1-	A	G1
Q 1113	IC				NJM78L05UA-TE1	G1091325		1-	A	C5
Q 1114	FET				BF1201WR_115	G3070425		1-	A	D2
Q 1115	TRANSISTOR				2SC2714Y(TE85R.F)	G3327147Y		1-	A	F2
Q 1116	TRANSISTOR				2SC4081 T106 R	G3340818R		1-	A	H3
Q 1117	TRANSISTOR				2SC4081 T106 R	G3340818R		1-	A	G3
Q 1119	TRANSISTOR				DTC114EUA T106	G3070084		1-	A	G2
Q 1120	IC				LM2904PWR	G1094010		1-	A	I1
Q 1121	IC				NJM2737V(TAPE)	G1094292		1-	A	I3
Q 1122	TRANSISTOR				DTC114EUA T106	G3070084		1-	A	G5
Q 1123	TRANSISTOR				2SB624-T2B BV3	G3206247C		1-	A	F5
Q 1124	TRANSISTOR				2SD1664 T100 Q	G3416647Q		1-	A	D6
Q 1901	IC				NJM2068V-TE1	G1094112		1-	A	F4
Q 1902	TRANSISTOR				2SA1576A T106 R	G3115768R		1-	A	G4
Q 1903	TRANSISTOR				2SA1576A T106 R	G3115768R		1-	A	G4
Q 1904	TRANSISTOR				2SC4081 T106 R	G3340818R		1-	A	G4
Q 1905	TRANSISTOR				2SD596A-T1B DV3	G3070431		1-	A	F4
Q 1906	TRANSISTOR				2SB624A-T1B BV3	G3070430		1-	A	G4
R 1003	CHIP RES.	100	1/16W	5%	RMC1/16 101JATP	J24185101		1-	A	H1
R 1004	CHIP RES.	100	1/16W	5%	RMC1/16 101JATP	J24185101		1-	A	H1
R 1005	CHIP RES.	100	1/16W	5%	RMC1/16 101JATP	J24185101		1-	A	B1
R 1006	CHIP RES.	470	1/16W	5%	RMC1/16 471JATP	J24185471		1-	A	A1
R 1008	CHIP RES.	1k	1/16W	5%	RMC1/16 102JATP	J24185102		1-	A	B1
R 1009	CHIP RES.	1k	1/16W	5%	RMC1/16 102JATP	J24185102		1-	A	I6
R 1010	CHIP RES.	100	1/16W	5%	RMC1/16 101JATP	J24185101		1-	A	A1
R 1012	CHIP RES.	47	1/16W	5%	RMC1/16 470JATP	J24185470		1-	A	A1
R 1013	CHIP RES.	4.7k	1/16W	5%	RMC1/16 472JATP	J24185472		1-	A	G6
R 1015	CHIP RES.	10k	1/16W	5%	RMC1/16 103JATP	J24185103		1-	A	I6
R 1016	CHIP RES.	100	1/16W	5%	RMC1/16 101JATP	J24185101		1-	A	A1
R 1017	CHIP RES.	100	1/16W	5%	RMC1/16 101JATP	J24185101		1-	A	A1
R 1019	CHIP RES.	47	1/16W	5%	RMC1/16 470JATP	J24185470		1-	A	G6
R 1020	CHIP RES.	10k	1/16W	5%	RMC1/16 103JATP	J24185103		1-	A	H1
R 1021	CHIP RES.	27	1/16W	5%	RMC1/16 270JATP	J24185270		1-	A	I6
R 1022	CHIP RES.	100	1/16W	5%	RMC1/16 101JATP	J24185101		1-	A	A1
R 1023	CHIP RES.	220	1/16W	5%	RMC1/16 221JATP	J24185221		1-	A	C1
R 1024	CHIP RES.	0	1/16W	5%	RMC1/16 000JATP	J24185000		1-	A	H1
R 1025	CHIP RES.	1k	1/16W	5%	RMC1/16 102JATP	J24185102		1-	A	B1
R 1026	CHIP RES.	27	1/16W	5%	RMC1/16 270JATP	J24185270		1-	A	I6
R 1027	CHIP RES.	39	1/16W	5%	RMC1/16 390JATP	J24185390		1-	A	I6
R 1028	CHIP RES.	100	1/16W	5%	RMC1/16 101JATP	J24185101		1-	A	A1
R 1029	CHIP RES.	4.7k	1/16W	5%	RMC1/16 472JATP	J24185472		1-	A	G6
R 1030	CHIP RES.	56	1/16W	5%	RMC1/16 560JATP	J24185560		1-	A	I6
R 1031	CHIP RES.	1k	1/16W	5%	RMC1/16 102JATP	J24185102		1-	A	H6
R 1032	CHIP RES.	33	1/16W	5%	RMC1/16 330JATP	J24185330		1-	A	H6
R 1033	CHIP RES.	10k	1/16W	5%	RMC1/16 103JATP	J24185103		1-	A	H6
R 1035	CHIP RES.	22	1/16W	5%	RMC1/16 220JATP	J24185220		1-	A	H6
R 1036	CHIP RES.	2.7k	1/16W	5%	RMC1/16 272JATP	J24185272		14-	A	H6
R 1037	CHIP RES.	100	1/16W	5%	RMC1/16 101JATP	J24185101		1-	A	I6
R 1038	CHIP RES.	1k	1/16W	5%	RMC1/16 102JATP	J24185102		1-	A	C1
R 1040	CHIP RES.	68	1/16W	5%	RMC1/16 680JATP	J24185680		1-	A	A2
R 1041	CHIP RES.	150	1/16W	5%	RMC1/16 151JATP	J24185151		1-	A	A2
R 1042	CHIP RES.	100	1/16W	5%	RMC1/16 101JATP	J24185101		1-	A	H2
R 1043	CHIP RES.	150	1/16W	5%	RMC1/16 151JATP	J24185151		1-	A	H6
R 1044	CHIP RES.	100	1/16W	5%	RMC1/16 101JATP	J24185101		1-	A	H6
R 1045	CHIP RES.	10k	1/16W	5%	RMC1/16 103JATP	J24185103		1-	A	H6
R 1046	CHIP RES.	1k	1/16W	5%	RMC1/16 102JATP	J24185102		1-	A	B1
R 1047	CHIP RES.	220	1/16W	5%	RMC1/16 221JATP	J24185221		1-	A	H6
R 1048	CHIP RES.	47k	1/16W	5%	RMC1/16 473JATP	J24185473		1-	A	H6
R 1049	CHIP RES.	22k	1/16W	5%	RMC1/16 223JATP	J24185223		1-	A	G6
R 1050	CHIP RES.	470	1/16W	5%	RMC1/16 471JATP	J24185471		1-	A	I5
R 1051	CHIP RES.	0	1/16W	5%	RMC1/16 000JATP	J24185000		1-	A	I6
R 1052	CHIP RES.	470	1/16W	5%	RMC1/16 471JATP	J24185471		1-	A	I5
R 1053	CHIP RES.	8.2	1/16W	5%	RMC1/16 8R2JATP	J24185829		1-	A	H6
R 1054	CHIP RES.	47	1/2W	5%	RMC1/2 470JCTP	J24275470		1-	A	H6
R 1055	CHIP RES.	470	1/16W	5%	RMC1/16 471JATP	J24185471		1-	A	I5
R 1056	CHIP RES.	100	1/16W	5%	RMC1/16 101JATP	J24185101		1-	A	I1
R 1057	CHIP RES.	10k	1/16W	1%	RMC1/16 103FTP	J24183103		1-	A	I5
R 1058	CHIP RES.	1k	1/16W	5%	RMC1/16 102JATP	J24185102		1-	A	H1

TRX Unit

Parts List

REF	DESCRIPTION	VALUE	V/W	TOL.	MFR'S DESIG	VXSTD P/N	VERS.	LOT	SIDE	LAY ADR
R 1059	CHIP RES.	20k	1/16W	1%	RMC1/16 203FTP	J24183203		1-	A	I5
R 1060	CHIP RES.	100	1/16W	5%	RMC1/16 101JATP	J24185101		1-	A	A1
R 1062	CHIP RES.	39k	1/16W	5%	RMC1/16 393JATP	J24185393		1-	A	I5
R 1063	CHIP RES.	330	1/10W	5%	RMC1/10T 331J	J24205331		1-	A	G6
R 1064	CHIP RES.	82k	1/16W	5%	RMC1/16 823JATP	J24185823		1-	A	I5
R 1065	CHIP RES.	47k	1/16W	5%	RMC1/16 473JATP	J24185473		1-	A	C4
R 1066	CHIP RES.	680	1/16W	5%	RMC1/16 681JATP	J24185681		1-	A	H6
R 1067	CHIP RES.	220	1/4W	5%	RMC1/4 221JATP	J24245221		1-	A	H6
R 1068	CHIP RES.	4.7k	1/16W	5%	RMC1/16 472JATP	J24185472		1-	A	H2
R 1069	CHIP RES.	220	1/16W	5%	RMC1/16 221JATP	J24185221		1-	A	G6
R 1070	CHIP RES.	47k	1/16W	5%	RMC1/16 473JATP	J24185473		1-	A	C4
R 1071	CHIP RES.	330	1/16W	5%	RMC1/16 331JATP	J24185331		1-	A	H6
R 1072	CHIP RES.	18	1/16W	5%	RMC1/16 180JATP	J24185180		1-	A	G6
R 1073	CHIP RES.	1k	1/16W	5%	RMC1/16 102JATP	J24185102		1-	A	H2
R 1074	CHIP RES.	1k	1/16W	5%	RMC1/16 102JATP	J24185102		1-	A	H1
R 1075	CHIP RES.	100k	1/16W	5%	RMC1/16 104JATP	J24185104		1-	A	H1
R 1076	CHIP RES.	47k	1/16W	5%	RMC1/16 473JATP	J24185473		1-	A	C4
R 1077	CHIP RES.	100	1/16W	5%	RMC1/16 101JATP	J24185101		1-	A	H6
R 1078	CHIP RES.	47k	1/16W	5%	RMC1/16 473JATP	J24185473		1-	A	C5
R 1079	CHIP RES.	33	1/16W	5%	RMC1/16 330JATP	J24185330		1-	A	B2
R 1080	CHIP RES.	0	1/16W	5%	RMC1/16 000JATP	J24185000		1-	A	J5
R 1081	CHIP RES.	0	1/16W	5%	RMC1/16 000JATP	J24185000		1-	A	J5
R 1082	CHIP RES.	1k	1/16W	5%	RMC1/16 102JATP	J24185102		1-	A	H1
R 1083	CHIP RES.	470	1/16W	5%	RMC1/16 471JATP	J24185471		1-	A	H1
R 1084	CHIP RES.	10k	1/16W	5%	RMC1/16 103JATP	J24185103		1-	A	I1
R 1085	CHIP RES.	470	1/16W	5%	RMC1/16 471JATP	J24185471		1-	A	I4
R 1086	CHIP RES.	100	1/16W	5%	RMC1/16 101JATP	J24185101		1-	A	B1
R 1087	CHIP RES.	1k	1/16W	5%	RMC1/16 102JATP	J24185102		1-	A	I1
R 1088	CHIP RES.	330	1/10W	5%	RMC1/10T 331J	J24205331		1-	A	B2
R 1089	CHIP RES.	330	1/16W	5%	RMC1/16 331JATP	J24185331		1-	A	G6
R 1090	CHIP RES.	330	1/16W	5%	RMC1/16 331JATP	J24185331		1-	A	G6
R 1091	CHIP RES.	330	1/10W	5%	RMC1/10T 331J	J24205331		1-	A	A2
R 1092	CHIP RES.	330	1/10W	5%	RMC1/10T 331J	J24205331		1-	A	A3
R 1093	CHIP RES.	330	1/10W	5%	RMC1/10T 331J	J24205331		1-	A	A3
R 1094	CHIP RES.	330	1/10W	5%	RMC1/10T 331J	J24205331		1-	A	A4
R 1095	CHIP RES.	330	1/16W	5%	RMC1/16 331JATP	J24185331		1-	A	G5
R 1096	CHIP RES.	330	1/16W	5%	RMC1/16 331JATP	J24185331		1-	A	G6
R 1097	CHIP RES.	470	1/16W	5%	RMC1/16 471JATP	J24185471		1-	A	I4
R 1098	CHIP RES.	68k	1/16W	5%	RMC1/16 683JATP	J24185683		1-	A	I1
R 1099	CHIP RES.	470	1/16W	5%	RMC1/16 471JATP	J24185471		1-	A	I4
R 1100	CHIP RES.	0	1/16W	5%	RMC1/16 000JATP	J24185000		1-	A	B2
R 1101	CHIP RES.	33	1/16W	5%	RMC1/16 330JATP	J24185330		1-	A	G5
R 1102	CHIP RES.	33	1/16W	5%	RMC1/16 330JATP	J24185330		1-	A	G6
R 1103	CHIP RES.	33	1/16W	5%	RMC1/16 330JATP	J24185330		1-	A	G6
R 1104	CHIP RES.	33	1/16W	5%	RMC1/16 330JATP	J24185330		1-	A	G6
R 1105	CHIP RES.	0	1/16W	5%	RMC1/16 000JATP	J24185000		1-	A	I5
R 1106	CHIP RES.	15k	1/16W	5%	RMC1/16 153JATP	J24185153		1-	A	I2
R 1107	CHIP RES.	33	1/16W	5%	RMC1/16 330JATP	J24185330		1-	A	B3
R 1108	CHIP RES.	33	1/16W	5%	RMC1/16 330JATP	J24185330		1-	A	B3
R 1109	CHIP RES.	33	1/16W	5%	RMC1/16 330JATP	J24185330		1-	A	B4
R 1110	CHIP RES.	33	1/16W	5%	RMC1/16 330JATP	J24185330		1-	A	B4
R 1111	CHIP RES.	0	1/16W	5%	RMC1/16 000JATP	J24185000		1-	A	I1
R 1112	CHIP RES.	330	1/16W	5%	RMC1/16 331JATP	J24185331		1-	A	F6
R 1113	CHIP RES.	330	1/16W	5%	RMC1/16 331JATP	J24185331		1-	A	F6
R 1114	CHIP RES.	330	1/16W	5%	RMC1/16 331JATP	J24185331		1-	A	F5
R 1115	CHIP RES.	330	1/16W	5%	RMC1/16 331JATP	J24185331		1-	A	F6
R 1117	CHIP RES.	330	1/10W	5%	RMC1/10T 331J	J24205331		1-	A	B2
R 1118	CHIP RES.	330	1/10W	5%	RMC1/10T 331J	J24205331		1-	A	B3
R 1119	CHIP RES.	330	1/10W	5%	RMC1/10T 331J	J24205331		1-	A	B3
R 1120	CHIP RES.	330	1/10W	5%	RMC1/10T 331J	J24205331		1-	A	B4
R 1121	CHIP RES.	470	1/16W	5%	RMC1/16 471JATP	J24185471		1-	A	J5
R 1122	CHIP RES.	470	1/16W	5%	RMC1/16 471JATP	J24185471		1-	A	J5
R 1123	CHIP RES.	220k	1/16W	5%	RMC1/16 224JATP	J24185224		1-	A	D2
R 1124	CHIP RES.	330k	1/16W	5%	RMC1/16 334JATP	J24185334		1-	A	D2
R 1125	CHIP RES.	10	1/16W	5%	RMC1/16 100JATP	J24185100		1-	A	H4
R 1126	CHIP RES.	0	1/16W	5%	RMC1/16 000JATP	J24185000		1-	A	D2
R 1127	CHIP RES.	0	1/16W	5%	RMC1/16 000JATP	J24185000		1-	A	C1
R 1128	CHIP RES.	4.7k	1/16W	5%	RMC1/16 472JATP	J24185472		1-	A	H4
R 1129	CHIP RES.	4.7k	1/16W	5%	RMC1/16 472JATP	J24185472		1-	A	H4
R 1130	CHIP RES.	680k	1/16W	5%	RMC1/16 684JATP	J24185684		1-	A	D2
R 1131	CHIP RES.	330	1/10W	5%	RMC1/10T 331J	J24205331		1-	A	F5
R 1132	CHIP RES.	470	1/16W	5%	RMC1/16 471JATP	J24185471		1-	A	H4
R 1133	CHIP RES.	470	1/16W	5%	RMC1/16 471JATP	J24185471		1-	A	H4

REF	DESCRIPTION	VALUE	V/W	TOL.	MFR'S DESIG	VXSTD P/N	VERS.	LOT	SIDE	LAY ADR
R 1134	CHIP RES.	470	1/16W	5%	RMC1/16 471JATP	J24185471		1-	A	H4
R 1135	CHIP RES.	470	1/16W	5%	RMC1/16 471JATP	J24185471		1-	A	C4
R 1136	CHIP RES.	47	1/16W	5%	RMC1/16 470JATP	J24185470		1-	A	D1
R 1137	CHIP RES.	330	1/10W	5%	RMC1/10T 331J	J24205331		1-	A	A4
R 1138	CHIP RES.	330	1/10W	5%	RMC1/10T 331J	J24205331		1-	A	A5
R 1139	CHIP RES.	330	1/10W	5%	RMC1/10T 331J	J24205331		1-	A	A5
R 1140	CHIP RES.	100	1/16W	5%	RMC1/16 101JATP	J24185101		1-	A	C2
R 1141	CHIP RES.	22k	1/16W	5%	RMC1/16 223JATP	J24185223		1-	A	D2
R 1142	CHIP RES.	470	1/16W	5%	RMC1/16 471JATP	J24185471		1-	A	C5
R 1144	CHIP RES.	22k	1/16W	1%	RMC1/16 223FTP	J24183223		1-	A	D1
R 1145	CHIP RES.	27	1/16W	5%	RMC1/16 270JATP	J24185270		1-	A	C3
R 1146	CHIP RES.	470	1/16W	5%	RMC1/16 471JATP	J24185471		1-	A	C4
R 1147	CHIP RES.	27	1/16W	5%	RMC1/16 270JATP	J24185270		1-	A	C3
R 1148	CHIP RES.	220k	1/16W	5%	RMC1/16 224JATP	J24185224		1-	A	D2
R 1149	CHIP RES.	33	1/16W	5%	RMC1/16 330JATP	J24185330		1-	A	C3
R 1150	CHIP RES.	22k	1/16W	1%	RMC1/16 223FTP	J24183223		1-	A	H5
R 1151	CHIP RES.	22k	1/16W	1%	RMC1/16 223FTP	J24183223		1-	A	G5
R 1152	CHIP RES.	12k	1/16W	1%	RMC1/16 123FTP	J24183123		1-	A	D1
R 1153	CHIP RES.	47k	1/16W	1%	RMC1/16 473FTP	J24183473		1-	A	G5
R 1154	CHIP RES.	47k	1/16W	1%	RMC1/16 473FTP	J24183473		1-	A	G5
R 1155	CHIP RES.	10k	1/16W	5%	RMC1/16 103JATP	J24185103		1-	A	G3
R 1156	CHIP RES.	33	1/16W	5%	RMC1/16 330JATP	J24185330		1-	A	B5
R 1157	CHIP RES.	33	1/16W	5%	RMC1/16 330JATP	J24185330		1-	A	B5
R 1158	CHIP RES.	33	1/16W	5%	RMC1/16 330JATP	J24185330		1-	A	B5
R 1159	CHIP RES.	8.2	1/16W	5%	RMC1/16 8R2JATP	J24185829		1-	A	E5
R 1160	CHIP RES.	47	1/16W	5%	RMC1/16 470JATP	J24185470		1-	A	G3
R 1161	CHIP RES.	47	1/16W	5%	RMC1/16 470JATP	J24185470		1-	A	D1
R 1162	CHIP RES.	2.2k	1/16W	5%	RMC1/16 222JATP	J24185222		1-	A	G3
R 1163	CHIP RES.	150	1/16W	5%	RMC1/16 151JATP	J24185151		1-	A	E5
R 1164	CHIP RES.	330	1/10W	5%	RMC1/10T 331J	J24205331		1-	A	B4
R 1165	CHIP RES.	330	1/10W	5%	RMC1/10T 331J	J24205331		1-	A	B5
R 1166	CHIP RES.	330	1/10W	5%	RMC1/10T 331J	J24205331		1-	A	B5
R 1167	CHIP RES.	8.2	1/16W	5%	RMC1/16 8R2JATP	J24185829		1-	A	E5
R 1168	CHIP RES.	4.7k	1/16W	1%	RMC1/16 472FTP	J24183472		1-	A	H5
R 1169	CHIP RES.	4.7k	1/16W	1%	RMC1/16 472FTP	J24183472		1-	A	H5
R 1170	CHIP RES.	100k	1/16W	5%	RMC1/16 104JATP	J24185104		1-	A	H5
R 1171	CHIP RES.	1k	1/16W	5%	RMC1/16 102JATP	J24185102		1-	A	E5
R 1172	CHIP RES.	4.7k	1/16W	1%	RMC1/16 472FTP	J24183472		1-	A	H5
R 1173	CHIP RES.	10k	1/16W	5%	RMC1/16 103JATP	J24185103		1-	A	H5
R 1174	CHIP RES.	4.7k	1/16W	1%	RMC1/16 472FTP	J24183472		1-	A	G3
R 1175	CHIP RES.	4.7k	1/16W	1%	RMC1/16 472FTP	J24183472		1-	A	H5
R 1176	CHIP RES.	68k	1/16W	5%	RMC1/16 683JATP	J24185683		1-	A	H5
R 1177	CHIP RES.	330	1/10W	5%	RMC1/10T 331J	J24205331		1-	A	B4
R 1178	CHIP RES.	68	1/16W	5%	RMC1/16 680JATP	J24185680		1-	A	C4
R 1179	CHIP RES.	150	1/16W	5%	RMC1/16 151JATP	J24185151		1-	A	E4
R 1180	CHIP RES.	100k	1/16W	5%	RMC1/16 104JATP	J24185104		1-	A	H5
R 1181	CHIP RES.	68k	1/16W	5%	RMC1/16 683JATP	J24185683		1-	A	G5
R 1182	CHIP RES.	330	1/10W	5%	RMC1/10T 331J	J24205331		1-	A	A2
R 1183	CHIP RES.	33	1/16W	5%	RMC1/16 330JATP	J24185330		1-	A	B2
R 1184	CHIP RES.	4.7k	1/16W	1%	RMC1/16 472FTP	J24183472		1-	A	G3
R 1185	CHIP RES.	33k	1/16W	5%	RMC1/16 333JATP	J24185333		1-	A	H5
R 1186	CHIP RES.	3.3M	1/16W	5%	RMC1/16 335JATP	J24185335		1-	A	G3
R 1187	CHIP RES.	150k	1/16W	5%	RMC1/16 154JATP	J24185154		1-	A	H5
R 1188	CHIP RES.	150k	1/16W	5%	RMC1/16 154JATP	J24185154		1-	A	G5
R 1189	CHIP RES.	10k	1/16W	5%	RMC1/16 103JATP	J24185103		1-	A	I5
R 1190	CHIP RES.	1k	1/16W	5%	RMC1/16 102JATP	J24185102		1-	A	A6
R 1191	CHIP RES.	33	1/16W	5%	RMC1/16 330JATP	J24185330		1-	A	F5
R 1192	CHIP RES.	4.7k	1/16W	5%	RMC1/16 472JATP	J24185472		1-	A	G5
R 1193	CHIP RES.	4.7k	1/16W	5%	RMC1/16 472JATP	J24185472		1-	A	H4
R 1194	CHIP RES.	220k	1/16W	5%	RMC1/16 224JATP	J24185224		1-	A	I5
R 1195	CHIP RES.	4.7k	1/16W	5%	RMC1/16 472JATP	J24185472		1-	A	C6
R 1196	CHIP RES.	470k	1/16W	5%	RMC1/16 474JATP	J24185474		1-	A	G3
R 1197	CHIP RES.	100	1/16W	5%	RMC1/16 101JATP	J24185101		1-	A	A6
R 1198	CHIP RES.	47	1/10W	5%	RMC1/10T 470J	J24205470		1-	A	B6
R 1199	CHIP RES.	39k	1/16W	5%	RMC1/16 393JATP	J24185393		1-	A	G5
R 1200	CHIP RES.	47	1/16W	5%	RMC1/16 470JATP	J24185470		1-	A	H5
R 1201	CHIP RES.	100	1/16W	5%	RMC1/16 101JATP	J24185101		1-	A	E5
R 1202	CHIP RES.	100k	1/16W	5%	RMC1/16 104JATP	J24185104		1-	A	G5
R 1203	CHIP RES.	0	1/16W	5%	RMC1/16 000JATP	J24185000		1-	A	H2
R 1204	CHIP RES.	47k	1/16W	5%	RMC1/16 473JATP	J24185473		1-	A	H5
R 1205	CHIP RES.	10k	1/16W	5%	RMC1/16 103JATP	J24185103		1-	A	H5
R 1206	CHIP RES.	4.7k	1/16W	5%	RMC1/16 472JATP	J24185472		1-	A	G3
R 1207	CHIP RES.	100k	1/16W	5%	RMC1/16 104JATP	J24185104		1-	A	G5

TRX Unit

Parts List

REF	DESCRIPTION	VALUE	V/W	TOL.	MFR'S DESIG	VXSTD P/N	VERS.	LOT	SIDE	LAY ADR
R 1208	CHIP RES.	33k	1/16W	5%	RMC1/16 333JATP	J24185333		1-	A	I5
R 1208	CHIP RES.	47k	1/16W	5%	RMC1/16 473JATP	J24185473		4-	A	I5
R 1209	CHIP RES.	33	1/16W	5%	RMC1/16 330JATP	J24185330		1-	A	E4
R 1210	CHIP RES.	100k	1/16W	5%	RMC1/16 104JATP	J24185104		1-	A	I5
R 1211	CHIP RES.	10k	1/16W	5%	RMC1/16 103JATP	J24185103		1-	A	G1
R 1212	CHIP RES.	470	1/16W	5%	RMC1/16 471JATP	J24185471		1-	A	G5
R 1213	CHIP RES.	33	1/16W	5%	RMC1/16 330JATP	J24185330		1-	A	B6
R 1214	CHIP RES.	330	1/16W	5%	RMC1/16 331JATP	J24185331		1-	A	B6
R 1215	CHIP RES.	47k	1/16W	5%	RMC1/16 473JATP	J24185473		1-	A	G4
R 1216	CHIP RES.	10k	1/16W	5%	RMC1/16 103JATP	J24185103		1-	A	G4
R 1217	CHIP RES.	1k	1/16W	5%	RMC1/16 102JATP	J24185102		1-	A	B6
R 1218	CHIP RES.	470k	1/16W	5%	RMC1/16 474JATP	J24185474		1-	A	H5
R 1219	CHIP RES.	4.7k	1/16W	1%	RMC1/16 472FTP	J24183472		1-	A	G3
R 1220	CHIP RES.	150k	1/16W	5%	RMC1/16 154JATP	J24185154		1-	A	G5
R 1221	CHIP RES.	47k	1/16W	5%	RMC1/16 473JATP	J24185473		1-	A	C6
R 1222	CHIP RES.	68k	1/16W	5%	RMC1/16 683JATP	J24185683		1-	A	H2
R 1223	CHIP RES.	100	1/16W	5%	RMC1/16 101JATP	J24185101		1-	A	E4
R 1224	CHIP RES.	10	1/16W	5%	RMC1/16 100JATP	J24185100		1-	A	B6
R 1225	CHIP RES.	10k	1/16W	5%	RMC1/16 103JATP	J24185103		1-	A	D2
R 1226	CHIP RES.	47	1/16W	5%	RMC1/16 470JATP	J24185470		1-	A	I2
R 1227	CHIP RES.	330	1/16W	5%	RMC1/16 331JATP	J24185331		1-	A	B6
R 1228	CHIP RES.	10k	1/16W	5%	RMC1/16 103JATP	J24185103		1-	A	D2
R 1229	CHIP RES.	18	1/16W	5%	RMC1/16 180JATP	J24185180		1-	A	B6
R 1230	CHIP RES.	10	1/16W	5%	RMC1/16 100JATP	J24185100		1-	A	B6
R 1231	CHIP RES.	1k	1/16W	5%	RMC1/16 102JATP	J24185102		1-	A	A6
R 1232	CHIP RES.	100	1/16W	5%	RMC1/16 101JATP	J24185101		1-	A	I5
R 1232	CHIP RES.	3.3k	1/16W	5%	RMC1/16 332JATP	J24185332		5-	A	I5
R 1233	CHIP RES.	3.9k	1/16W	5%	RMC1/16 392JATP	J24185392		1-	A	E4
R 1234	CHIP RES.	47	1/16W	5%	RMC1/16 470JATP	J24185470		1-	A	E4
R 1235	CHIP RES.	10k	1/16W	5%	RMC1/16 103JATP	J24185103		1-	A	E4
R 1236	CHIP RES.	10k	1/16W	5%	RMC1/16 103JATP	J24185103		1-	A	G4
R 1237	CHIP RES.	47	1/10W	5%	RMC1/10T 470J	J24205470		1-	A	A6
R 1238	CHIP RES.	330	1/16W	5%	RMC1/16 331JATP	J24185331		1-	A	B6
R 1239	CHIP RES.	10k	1/16W	5%	RMC1/16 103JATP	J24185103		1-	A	E4
R 1240	CHIP RES.	22k	1/16W	5%	RMC1/16 223JATP	J24185223		1-	A	E4
R 1241	CHIP RES.	2.2k	1/16W	5%	RMC1/16 222JATP	J24185222		1-	A	E4
R 1242	CHIP RES.	2.2k	1/16W	5%	RMC1/16 222JATP	J24185222		1-	A	G4
R 1243	CHIP RES.	150k	1/16W	5%	RMC1/16 154JATP	J24185154		1-	A	G3
R 1244	CHIP RES.	10k	1/16W	5%	RMC1/16 103JATP	J24185103		1-	A	H2
R 1245	CHIP RES.	47	1/16W	5%	RMC1/16 470JATP	J24185470		1-	A	H2
R 1246	CHIP RES.	470k	1/16W	5%	RMC1/16 474JATP	J24185474		1-	A	H4
R 1247	CHIP RES.	47	1/16W	5%	RMC1/16 470JATP	J24185470		1-	A	E4
R 1248	CHIP RES.	47k	1/16W	5%	RMC1/16 473JATP	J24185473		1-	A	G5
R 1249	CHIP RES.	2.2k	1/16W	5%	RMC1/16 222JATP	J24185222		1-	A	G4
R 1250	CHIP RES.	2.2k	1/16W	5%	RMC1/16 222JATP	J24185222		1-	A	G4
R 1251	CHIP RES.	6.8k	1/16W	5%	RMC1/16 682JATP	J24185682		1-	A	G4
R 1252	CHIP RES.	47	1/16W	5%	RMC1/16 470JATP	J24185470		1-	A	E4
R 1253	CHIP RES.	15k	1/16W	5%	RMC1/16 153JATP	J24185153		1-	A	D2
R 1254	CHIP RES.	33	1/16W	5%	RMC1/16 330JATP	J24185330		1-	A	A6
R 1255	CHIP RES.	330	1/16W	5%	RMC1/16 331JATP	J24185331		1-	A	A6
R 1256	CHIP RES.	3.3k	1/16W	5%	RMC1/16 332JATP	J24185332		1-	A	I5
R 1256	CHIP RES.	10k	1/16W	5%	RMC1/16 103JATP	J24185103		4-	A	I5
R 1257	CHIP RES.	100k	1/16W	5%	RMC1/16 104JATP	J24185104		1-	A	D2
R 1258	CHIP RES.	1k	1/16W	5%	RMC1/16 102JATP	J24185102		1-	A	A6
R 1259	CHIP RES.	22k	1/16W	5%	RMC1/16 223JATP	J24185223		1-	A	D2
R 1260	CHIP RES.	0	1/16W	5%	RMC1/16 000JATP	J24185000		1-	A	G4
R 1261	CHIP RES.	100	1/16W	5%	RMC1/16 101JATP	J24185101		1-	A	B6
R 1262	CHIP RES.	470k	1/16W	5%	RMC1/16 474JATP	J24185474		1-	A	G4
R 1263	CHIP RES.	2.2k	1/16W	5%	RMC1/16 222JATP	J24185222		1-	A	G4
R 1264	CHIP RES.	10k	1/16W	5%	RMC1/16 103JATP	J24185103		1-	A	G5
R 1265	CHIP RES.	10k	1/16W	5%	RMC1/16 103JATP	J24185103		1-	A	I5
R 1265	CHIP RES.	33k	1/16W	5%	RMC1/16 333JATP	J24185333		4-	A	I5
R 1266	CHIP RES.	220	1/16W	5%	RMC1/16 221JATP	J24185221		1-	A	I5
R 1266	CHIP RES.	680	1/16W	5%	RMC1/16 681JATP	J24185681		4-	A	I5
R 1267	CHIP RES.	10	1/16W	5%	RMC1/16 100JATP	J24185100		1-	A	A6
R 1268	CHIP RES.	330k	1/16W	5%	RMC1/16 334JATP	J24185334		1-	A	G4
R 1269	CHIP RES.	47k	1/16W	5%	RMC1/16 473JATP	J24185473		1-	A	G5
R 1270	CHIP RES.	47	1/16W	5%	RMC1/16 470JATP	J24185470		1-	A	H4
R 1271	CHIP RES.	10	1/16W	5%	RMC1/16 100JATP	J24185100		1-	A	A6
R 1272	CHIP RES.	100k	1/16W	5%	RMC1/16 104JATP	J24185104		1-	A	F4
R 1273	CHIP RES.	100	1/16W	5%	RMC1/16 101JATP	J24185101		1-	A	E4
R 1274	CHIP RES.	470	1/16W	5%	RMC1/16 471JATP	J24185471		1-	A	G5
R 1275	CHIP RES.	22k	1/16W	5%	RMC1/16 223JATP	J24185223		1-	A	D2

Parts List

REF	DESCRIPTION	VALUE	V/W	TOL.	MFR'S DESIG	VXSTD P/N	VERS.	LOT	SIDE	LAY ADR
R 1276	CHIP RES.	100k	1/16W	5%	RMC1/16 104JATP	J24185104		1-	A	I5
R 1277	CHIP RES.	33k	1/16W	5%	RMC1/16 333JATP	J24185333		1-	A	I5
R 1277	CHIP RES.	22k	1/16W	5%	RMC1/16 223JATP	J24185223		4-	A	I5
R 1278	CHIP RES.	47	1/16W	5%	RMC1/16 470JATP	J24185470		1-	A	D2
R 1279	CHIP RES.	39k	1/16W	5%	RMC1/16 393JATP	J24185393		1-	A	I2
R 1280	CHIP RES.	2.2k	1/16W	5%	RMC1/16 222JATP	J24185222		1-	A	I2
R 1281	CHIP RES.	100k	1/16W	5%	RMC1/16 104JATP	J24185104		1-	A	E4
R 1282	CHIP RES.	4.7k	1/16W	5%	RMC1/16 472JATP	J24185472		1-	A	G5
R 1283	CHIP RES.	330	1/10W	5%	RMC1/10T 331J	J24205331		1-	A	B6
R 1284	CHIP RES.	10k	1/16W	5%	RMC1/16 103JATP	J24185103		1-	A	G4
R 1285	CHIP RES.	470	1/16W	5%	RMC1/16 471JATP	J24185471		1-	A	G5
R 1286	CHIP RES.	47k	1/16W	5%	RMC1/16 473JATP	J24185473		1-	A	I5
R 1286	CHIP RES.	22k	1/16W	5%	RMC1/16 223JATP	J24185223		4-	A	I5
R 1287	CHIP RES.	33k	1/16W	5%	RMC1/16 333JATP	J24185333		1-	A	G4
R 1288	CHIP RES.	68	1/16W	5%	RMC1/16 680JATP	J24185680		1-	A	C6
R 1289	CHIP RES.	100k	1/16W	5%	RMC1/16 104JATP	J24185104		1-	A	G5
R 1290	CHIP RES.	10k	1/16W	5%	RMC1/16 103JATP	J24185103		1-	A	G4
R 1291	CHIP RES.	22k	1/16W	5%	RMC1/16 223JATP	J24185223		1-	A	D2
R 1292	CHIP RES.	2.2k	1/16W	5%	RMC1/16 222JATP	J24185222		1-	A	I5
R 1293	CHIP RES.	5.6k	1/16W	5%	RMC1/16 562JATP	J24185562		1-	A	I2
R 1294	CHIP RES.	1.5k	1/16W	5%	RMC1/16 152JATP	J24185152		1-	A	E4
R 1295	CHIP RES.	10k	1/16W	5%	RMC1/16 103JATP	J24185103		1-	A	G5
R 1296	CHIP RES.	10k	1/16W	5%	RMC1/16 103JATP	J24185103		1-	A	H4
R 1297	CHIP RES.	220	1/16W	5%	RMC1/16 221JATP	J24185221		1-	A	C6
R 1298	CHIP RES.	18	1/16W	5%	RMC1/16 180JATP	J24185180		1-	A	B6
R 1299	CHIP RES.	470k	1/16W	5%	RMC1/16 474JATP	J24185474		1-	A	F5
R 1300	CHIP RES.	2.2k	1/16W	5%	RMC1/16 222JATP	J24185222		1-	A	F5
R 1301	CHIP RES.	68k	1/16W	5%	RMC1/16 683JATP	J24185683		1-	A	G4
R 1303	CHIP RES.	47k	1/16W	1%	RMC1/16 473FTP	J24183473		1-	A	G5
R 1304	CHIP RES.	10k	1/16W	5%	RMC1/16 103JATP	J24185103		1-	A	D2
R 1306	CHIP RES.	10k	1/16W	5%	RMC1/16 103JATP	J24185103		1-	A	H4
R 1307	CHIP RES.	0	1/16W	5%	RMC1/16 000JATP	J24185000		1-	A	H2
R 1308	CHIP RES.	10k	1/16W	5%	RMC1/16 103JATP	J24185103		1-	A	E3
R 1310	CHIP RES.	10k	1/16W	5%	RMC1/16 103JATP	J24185103		1-	A	G4
R 1311	CHIP RES.	560	1/16W	5%	RMC1/16 561JATP	J24185561		1-	A	E3
R 1312	CHIP RES.	0	1/16W	5%	RMC1/16 000JATP	J24185000		1-	A	D6
R 1313	CHIP RES.	47	1/16W	5%	RMC1/16 470JATP	J24185470		1-	A	I4
R 1314	CHIP RES.	0	1/16W	5%	RMC1/16 000JATP	J24185000		1-	A	C6
R 1315	CHIP RES.	330	1/10W	5%	RMC1/10T 331J	J24205331		1-	A	C6
R 1316	CHIP RES.	100	1/16W	5%	RMC1/16 101JATP	J24185101		1-	A	D6
R 1317	CHIP RES.	47k	1/16W	5%	RMC1/16 473JATP	J24185473		1-	A	C4
R 1318	CHIP RES.	3.3k	1/16W	5%	RMC1/16 332JATP	J24185332		1-	A	D2
R 1319	CHIP RES.	100k	1/16W	5%	RMC1/16 104JATP	J24185104		1-	A	G4
R 1320	CHIP RES.	10k	1/16W	5%	RMC1/16 103JATP	J24185103		1-	A	I4
R 1321	CHIP RES.	10k	1/16W	5%	RMC1/16 103JATP	J24185103		1-	A	G4
R 1324	CHIP RES.	33k	1/16W	5%	RMC1/16 333JATP	J24185333		1-	A	H4
R 1325	CHIP RES.	180	1/16W	5%	RMC1/16 181JATP	J24185181		1-	A	E3
R 1326	CHIP RES.	3.9k	1/16W	5%	RMC1/16 392JATP	J24185392		1-	A	G5
R 1327	CHIP RES.	47k	1/16W	1%	RMC1/16 473FTP	J24183473		1-	A	G4
R 1328	CHIP RES.	100k	1/16W	1%	RMC1/16 104FTP	J24183104		1-	A	G4
R 1329	CHIP RES.	6.8k	1/16W	5%	RMC1/16 682JATP	J24185682		1-	A	H4
R 1330	CHIP RES.	33k	1/16W	5%	RMC1/16 333JATP	J24185333		1-	A	H5
R 1331	CHIP RES.	1.5k	1/16W	5%	RMC1/16 152JATP	J24185152		1-	A	E3
R 1332	CHIP RES.	68k	1/16W	5%	RMC1/16 683JATP	J24185683		1-	A	H4
R 1333	CHIP RES.	150k	1/16W	5%	RMC1/16 154JATP	J24185154		1-	A	D3
R 1334	CHIP RES.	3.3k	1/16W	5%	RMC1/16 332JATP	J24185332		1-	A	G4
R 1335	CHIP RES.	68k	1/16W	5%	RMC1/16 683JATP	J24185683		1-	A	D3
R 1336	CHIP RES.	1k	1/16W	1%	RMC1/16 102FTP	J24183102		1-	A	I4
R 1337	CHIP RES.	100k	1/16W	1%	RMC1/16 104FTP	J24183104		1-	A	G5
R 1338	CHIP RES.	120	1/10W	5%	RMC1/10T 121J	J24205121		1-	A	E3
R 1339	CHIP RES.	47	1/10W	5%	RMC1/10T 470J	J24205470		1-	A	E3
R 1341	CHIP RES.	4.7k	1/16W	5%	RMC1/16 472JATP	J24185472		1-	A	G4
R 1342	CHIP RES.	47	1/16W	5%	RMC1/16 470JATP	J24185470		1-	A	C6
R 1343	CHIP RES.	47	1/16W	5%	RMC1/16 470JATP	J24185470		1-	A	C6
R 1344	CHIP RES.	47k	1/16W	5%	RMC1/16 473JATP	J24185473		1-	A	C4
R 1347	CHIP RES.	1k	1/16W	5%	RMC1/16 102JATP	J24185102		1-	A	F4
R 1348	CHIP RES.	47	1/16W	5%	RMC1/16 470JATP	J24185470		1-	A	H4
R 1349	CHIP RES.	0	1/16W	5%	RMC1/16 000JATP	J24185000		1-	A	H2
R 1350	CHIP RES.	1k	1/16W	1%	RMC1/16 102FTP	J24183102		1-	A	I4
R 1351	CHIP RES.	4.7k	1/16W	5%	RMC1/16 472JATP	J24185472		1-	A	G5
R 1352	CHIP RES.	100k	1/16W	5%	RMC1/16 104JATP	J24185104		1-	A	H4
R 1353	CHIP RES.	47k	1/16W	5%	RMC1/16 473JATP	J24185473		1-	A	D2
R 1354	CHIP RES.	47	1/16W	5%	RMC1/16 470JATP	J24185470		1-	A	F4

TRX Unit

Parts List

REF	DESCRIPTION	VALUE	V/W	TOL.	MFR'S DESIG	VXSTD P/N	VERS.	LOT	SIDE	LAY ADR
R 1355	CHIP RES.	100k	1/16W	5%	RMC1/16 104JATP	J24185104		1-	A	E1
R 1356	CHIP RES.	100k	1/16W	5%	RMC1/16 104JATP	J24185104		1-	A	E1
R 1357	CHIP RES.	47k	1/16W	5%	RMC1/16 473JATP	J24185473		1-	A	C4
R 1359	CHIP RES.	150k	1/16W	5%	RMC1/16 154JATP	J24185154		1-	A	D2
R 1360	CHIP RES.	68k	1/16W	5%	RMC1/16 683JATP	J24185683		1-	A	D3
R 1361	CHIP RES.	470	1/16W	5%	RMC1/16 471JATP	J24185471		1-	A	I4
R 1362	CHIP RES.	47	1/16W	5%	RMC1/16 470JATP	J24185470		1-	A	I4
R 1363	CHIP RES.	470	1/16W	5%	RMC1/16 471JATP	J24185471		1-	A	I4
R 1365	CHIP RES.	470	1/16W	5%	RMC1/16 471JATP	J24185471		1-	A	I4
R 1366	CHIP RES.	100	1/16W	5%	RMC1/16 101JATP	J24185101		1-	A	C6
R 1367	CHIP RES.	100	1/16W	5%	RMC1/16 101JATP	J24185101		1-	A	C6
R 1368	CHIP RES.	33k	1/16W	5%	RMC1/16 333JATP	J24185333		1-	A	H4
R 1369	CHIP RES.	1k	1/16W	5%	RMC1/16 102JATP	J24185102		1-	A	E6
R 1370	CHIP RES.	33k	1/16W	5%	RMC1/16 333JATP	J24185333		1-	A	D6
R 1372	CHIP RES.	100k	1/16W	5%	RMC1/16 104JATP	J24185104		1-	A	C6
R 1373	CHIP RES.	10k	1/16W	5%	RMC1/16 103JATP	J24185103		1-	A	E1
R 1374	CHIP RES.	100	1/16W	5%	RMC1/16 101JATP	J24185101		1-	A	F4
R 1375	CHIP RES.	10k	1/16W	5%	RMC1/16 103JATP	J24185103		1-	A	H3
R 1376	CHIP RES.	10k	1/16W	5%	RMC1/16 103JATP	J24185103		1-	A	E1
R 1377	CHIP RES.	47k	1/16W	5%	RMC1/16 473JATP	J24185473		1-	A	C4
R 1378	CHIP RES.	10	1/4W	5%	RMC1/4 100JATP	J24245100		1-	A	C6
R 1379	CHIP RES.	0	1/10W	5%	RMC1/10T 000J	J24205000		1-	A	D6
R 1380	CHIP RES.	100k	1/16W	5%	RMC1/16 104JATP	J24185104		1-	A	C6
R 1382	CHIP RES.	3.3k	1/16W	5%	RMC1/16 332JATP	J24185332		1-	A	F4
R 1383	CHIP RES.	100k	1/16W	5%	RMC1/16 104JATP	J24185104		1-	A	E1
R 1384	CHIP RES.	100k	1/16W	5%	RMC1/16 104JATP	J24185104		1-	A	E1
R 1385	CHIP RES.	100k	1/16W	5%	RMC1/16 104JATP	J24185104		1-	A	H3
R 1385	CHIP RES.	100k	1/16W	1%	RMC1/16 104FTP	J24183104		4-	A	H3
R 1386	CHIP RES.	33k	1/16W	5%	RMC1/16 333JATP	J24185333		1-	A	C6
R 1387	CHIP RES.	0	1/16W	5%	RMC1/16 000JATP	J24185000		1-	A	F4
R 1388	CHIP RES.	10k	1/16W	5%	RMC1/16 103JATP	J24185103		1-	A	F4
R 1389	CHIP RES.	4.7k	1/16W	5%	RMC1/16 472JATP	J24185472		1-	A	E6
R 1390	CHIP RES.	10k	1/16W	5%	RMC1/16 103JATP	J24185103		1-	A	E6
R 1391	CHIP RES.	2.2k	1/16W	5%	RMC1/16 222JATP	J24185222		1-	A	G3
R 1392	CHIP RES.	47k	1/16W	5%	RMC1/16 473JATP	J24185473		1-	A	C4
R 1393	CHIP RES.	1.5k	1/16W	5%	RMC1/16 152JATP	J24185152		1-	A	F3
R 1394	CHIP RES.	4.7k	1/16W	5%	RMC1/16 472JATP	J24185472		1-	A	I4
R 1395	CHIP RES.	10k	1/16W	5%	RMC1/16 103JATP	J24185103		1-	A	F4
R 1396	CHIP RES.	33k	1/16W	5%	RMC1/16 333JATP	J24185333		1-	A	H3
R 1396	CHIP RES.	33k	1/16W	1%	RMC1/16 333FTP	J24183333		4-	A	H3
R 1397	CHIP RES.	47k	1/16W	5%	RMC1/16 473JATP	J24185473		1-	A	C5
R 1398	CHIP RES.	4.7k	1/16W	5%	RMC1/16 472JATP	J24185472		1-	A	G3
R 1399	CHIP RES.	68	1/10W	5%	RMC1/10T 680J	J24205680		1-	A	D5
R 1400	CHIP RES.	4.7	1/16W	5%	RMC1/16 4R7JATP	J24185479		1-	A	D3
R 1401	CHIP RES.	1.5k	1/16W	5%	RMC1/16 152JATP	J24185152		1-	A	F3
R 1402	CHIP RES.	1k	1/16W	5%	RMC1/16 102JATP	J24185102		1-	A	D3
R 1403	CHIP RES.	68k	1/16W	5%	RMC1/16 683JATP	J24185683		1-	A	G3
R 1404	CHIP RES.	100	1/16W	5%	RMC1/16 101JATP	J24185101		1-	A	F3
R 1405	CHIP RES.	1.5k	1/16W	5%	RMC1/16 152JATP	J24185152		1-	A	I3
R 1406	CHIP RES.	100k	1/16W	5%	RMC1/16 104JATP	J24185104		1-	A	I3
R 1407	CHIP RES.	100	1/16W	5%	RMC1/16 101JATP	J24185101		1-	A	D2
R 1408	CHIP RES.	47	1/16W	5%	RMC1/16 470JATP	J24185470		1-	A	I2
R 1409	CHIP RES.	330	1/16W	5%	RMC1/16 331JATP	J24185331		1-	A	F3
R 1410	CHIP RES.	100k	1/16W	5%	RMC1/16 104JATP	J24185104		1-	A	H3
R 1411	CHIP RES.	33k	1/16W	5%	RMC1/16 333JATP	J24185333		1-	A	J2
R 1412	CHIP RES.	33k	1/16W	5%	RMC1/16 333JATP	J24185333		1-	A	J2
R 1413	CHIP RES.	33k	1/16W	5%	RMC1/16 333JATP	J24185333		1-	A	J2
R 1414	CHIP RES.	33k	1/16W	5%	RMC1/16 333JATP	J24185333		1-	A	J2
R 1415	CHIP RES.	33k	1/16W	5%	RMC1/16 333JATP	J24185333		1-	A	I2
R 1416	CHIP RES.	33k	1/16W	5%	RMC1/16 333JATP	J24185333		1-	A	I2
R 1417	CHIP RES.	33k	1/16W	5%	RMC1/16 333JATP	J24185333		1-	A	I2
R 1418	CHIP RES.	33k	1/16W	5%	RMC1/16 333JATP	J24185333		1-	A	I3
R 1419	CHIP RES.	33k	1/16W	5%	RMC1/16 333JATP	J24185333		1-	A	I3
R 1420	CHIP RES.	33k	1/16W	5%	RMC1/16 333JATP	J24185333		1-	A	I3
R 1421	CHIP RES.	47k	1/16W	5%	RMC1/16 473JATP	J24185473		1-	A	C4
R 1422	CHIP RES.	10	1/16W	5%	RMC1/16 100JATP	J24185100		1-	A	E6
R 1423	CHIP RES.	100k	1/16W	5%	RMC1/16 104JATP	J24185104		1-	A	D4
R 1424	CHIP RES.	3.3k	1/16W	5%	RMC1/16 332JATP	J24185332		1-	A	D3
R 1425	CHIP RES.	100k	1/16W	5%	RMC1/16 104JATP	J24185104		1-	A	I4
R 1426	CHIP RES.	4.7k	1/16W	5%	RMC1/16 472JATP	J24185472		1-	A	G2
R 1427	CHIP RES.	47k	1/16W	5%	RMC1/16 473JATP	J24185473		1-	A	C5
R 1428	CHIP RES.	33	1/16W	5%	RMC1/16 330JATP	J24185330		1-	A	D5
R 1429	CHIP RES.	470	1/16W	5%	RMC1/16 471JATP	J24185471		1-	A	D5

REF	DESCRIPTION	VALUE	V/W	TOL.	MFR'S DESIG	VXSTD P/N	VERS.	LOT	SIDE	LAY ADR
R 1430	CHIP RES.	100k	1/16W	5%	RMC1/16 104JATP	J24185104		1-	A	G3
R 1431	CHIP RES.	100k	1/16W	5%	RMC1/16 104JATP	J24185104		1-	A	I4
R 1432	CHIP RES.	100k	1/16W	5%	RMC1/16 104JATP	J24185104		1-	A	D2
R 1433	CHIP RES.	1k	1/16W	5%	RMC1/16 102JATP	J24185102		1-	A	D5
R 1434	CHIP RES.	1k	1/16W	5%	RMC1/16 102JATP	J24185102		1-	A	I4
R 1435	CHIP RES.	100k	1/16W	5%	RMC1/16 104JATP	J24185104		1-	A	G2
R 1436	CHIP RES.	4.7k	1/16W	5%	RMC1/16 472JATP	J24185472		1-4	A	I4
R 1437	CHIP RES.	680	1/16W	5%	RMC1/16 681JATP	J24185681		1-	A	D4
R 1438	CHIP RES.	1k	1/16W	5%	RMC1/16 102JATP	J24185102		1-	A	I4
R 1439	CHIP RES.	100k	1/16W	5%	RMC1/16 104JATP	J24185104		1-	A	H3
R 1440	CHIP RES.	3.3k	1/16W	5%	RMC1/16 332JATP	J24185332		1-	A	F2
R 1441	CHIP RES.	10	1/16W	5%	RMC1/16 100JATP	J24185100		1-	A	H4
R 1442	CHIP RES.	33k	1/16W	5%	RMC1/16 333JATP	J24185333		1-	A	J2
R 1443	CHIP RES.	10	1/16W	5%	RMC1/16 100JATP	J24185100		1-	A	D5
R 1444	CHIP RES.	10	1/16W	5%	RMC1/16 100JATP	J24185100		1-	A	D5
R 1445	CHIP RES.	47k	1/16W	5%	RMC1/16 473JATP	J24185473		1-	A	C4
R 1446	CHIP RES.	100k	1/16W	5%	RMC1/16 104JATP	J24185104		1-	A	I3
R 1447	CHIP RES.	220k	1/16W	5%	RMC1/16 224JATP	J24185224	AUSTRALIA	1-	A	I3
R 1447	CHIP RES.	220k	1/16W	5%	RMC1/16 224JATP	J24185224	EUROPE	1-	A	I3
R 1447	CHIP RES.	220k	1/16W	5%	RMC1/16 224JATP	J24185224	EXPORT	1-	A	I3
R 1447	CHIP RES.	220k	1/16W	5%	RMC1/16 224JATP	J24185224	FRANCE	1-	A	I3
R 1447	CHIP RES.	220k	1/16W	5%	RMC1/16 224JATP	J24185224	UNITED KINGDOM	1-	A	I3
R 1447	CHIP RES.	220k	1/16W	5%	RMC1/16 224JATP	J24185224	USA	1-	A	I3
R 1448	CHIP RES.	220k	1/16W	5%	RMC1/16 224JATP	J24185224	AUSTRALIA	1-	A	I3
R 1448	CHIP RES.	220k	1/16W	5%	RMC1/16 224JATP	J24185224	EUROPE	1-	A	I3
R 1448	CHIP RES.	220k	1/16W	5%	RMC1/16 224JATP	J24185224	EXPORT	1-	A	I3
R 1448	CHIP RES.	220k	1/16W	5%	RMC1/16 224JATP	J24185224	FRANCE	1-	A	I3
R 1448	CHIP RES.	220k	1/16W	5%	RMC1/16 224JATP	J24185224	UNITED KINGDOM	1-	A	I3
R 1448	CHIP RES.	220k	1/16W	5%	RMC1/16 224JATP	J24185224	USA	1-	A	I3
R 1449	CHIP RES.	22k	1/16W	5%	RMC1/16 223JATP	J24185223		1-	A	D2
R 1451	CHIP RES.	1k	1/16W	5%	RMC1/16 102JATP	J24185102		1-	A	C1
R 1452	CHIP RES.	100k	1/16W	5%	RMC1/16 104JATP	J24185104		1-	A	C1
R 1453	CHIP RES.	0	1/16W	5%	RMC1/16 000JATP	J24185000		1-	A	D5
R 1454	CHIP RES.	0	1/16W	5%	RMC1/16 000JATP	J24185000		1-	A	D5
R 1455	CHIP RES.	47k	1/16W	5%	RMC1/16 473JATP	J24185473		1-	A	C5
R 1456	CHIP RES.	100	1/16W	5%	RMC1/16 101JATP	J24185101		1-	A	F3
R 1457	CHIP RES.	100k	1/16W	5%	RMC1/16 104JATP	J24185104		1-	A	J2
R 1458	CHIP RES.	2.2k	1/16W	5%	RMC1/16 222JATP	J24185222		1-	A	E6
R 1459	CHIP RES.	100	1/16W	5%	RMC1/16 101JATP	J24185101		1-	A	D4
R 1461	CHIP RES.	1k	1/16W	5%	RMC1/16 102JATP	J24185102		1-	A	F2
R 1462	CHIP RES.	470	1/16W	5%	RMC1/16 471JATP	J24185471		1-	A	F3
R 1463	CHIP RES.	4.7k	1/16W	5%	RMC1/16 472JATP	J24185472		1-	A	I2
R 1464	CHIP RES.	15k	1/16W	5%	RMC1/16 153JATP	J24185153		1-	A	J2
R 1464	CHIP RES.	18k	1/16W	5%	RMC1/16 183JATP	J24185183		4-	A	J2
R 1465	CHIP RES.	4.7k	1/16W	5%	RMC1/16 472JATP	J24185472		1-	A	I3
R 1466	CHIP RES.	2.2k	1/16W	5%	RMC1/16 222JATP	J24185222		1-	A	F3
R 1467	CHIP RES.	4.7k	1/16W	5%	RMC1/16 472JATP	J24185472		1-	A	D2
R 1468	CHIP RES.	1.8k	1/16W	5%	RMC1/16 182JATP	J24185182		1-	A	F2
R 1469	CHIP RES.	470	1/16W	5%	RMC1/16 471JATP	J24185471		1-	A	D4
R 1470	CHIP RES.	820	1/16W	5%	RMC1/16 821JATP	J24185821		1-	A	H2
R 1471	CHIP RES.	47	1/16W	5%	RMC1/16 470JATP	J24185470		1-	A	F3
R 1472	CHIP RES.	1.2k	1/16W	5%	RMC1/16 122JATP	J24185122		1-	A	H2
R 1473	CHIP RES.	0	1/16W	5%	RMC1/16 000JATP	J24185000		1-	A	D4
R 1475	CHIP RES.	1k	1/16W	5%	RMC1/16 102JATP	J24185102		1-	A	C4
R 1476	CHIP RES.	1k	1/16W	5%	RMC1/16 102JATP	J24185102		1-	A	C1
R 1477	CHIP RES.	2.2k	1/16W	5%	RMC1/16 222JATP	J24185222		1-	A	F3
R 1478	CHIP RES.	470	1/16W	5%	RMC1/16 471JATP	J24185471		1-	A	F3
R 1479	CHIP RES.	330	1/10W	5%	RMC1/10T 331J	J24205331		1-	A	D3
R 1480	CHIP RES.	330	1/10W	5%	RMC1/10T 331J	J24205331		1-	A	E3
R 1481	CHIP RES.	33k	1/16W	5%	RMC1/16 333JATP	J24185333		1-	A	F6
R 1482	CHIP RES.	820	1/16W	5%	RMC1/16 821JATP	J24185821		1-	A	H2
R 1483	CHIP RES.	3.3k	1/16W	5%	RMC1/16 332JATP	J24185332		1-	A	J2
R 1484	CHIP RES.	4.7	1/10W	5%	RMC1/10T 4R7J	J24205479		1-	A	E6
R 1485	CHIP RES.	270	1/16W	5%	RMC1/16 271JATP	J24185271		1-	A	E2
R 1486	CHIP RES.	270	1/16W	5%	RMC1/16 271JATP	J24185271		1-	A	E2
R 1487	CHIP RES.	270	1/16W	5%	RMC1/16 271JATP	J24185271		1-	A	E1
R 1488	CHIP RES.	270	1/16W	5%	RMC1/16 271JATP	J24185271		1-	A	E2
R 1489	CHIP RES.	33	1/16W	5%	RMC1/16 330JATP	J24185330		1-	A	E2
R 1490	CHIP RES.	10k	1/16W	5%	RMC1/16 103JATP	J24185103		1-	A	I2
R 1491	CHIP RES.	47	1/16W	5%	RMC1/16 470JATP	J24185470		1-	A	F2
R 1492	CHIP RES.	10	1/16W	5%	RMC1/16 100JATP	J24185100		1-	A	E3
R 1493	CHIP RES.	390	1/16W	5%	RMC1/16 391JATP	J24185391		1-	A	F3
R 1494	CHIP RES.	3.3k	1/16W	5%	RMC1/16 332JATP	J24185332		1-	A	I3

TRX Unit

Parts List

REF	DESCRIPTION	VALUE	V/W	TOL.	MFR'S DESIG	VXSTD P/N	VERS.	LOT	SIDE	LAY ADR
R 1495	CHIP RES.	1k	1/16W	5%	RMC1/16 102JATP	J24185102		1-	A	E1
R 1496	CHIP RES.	18	1/16W	5%	RMC1/16 180JATP	J24185180		1-	A	E2
R 1497	CHIP RES.	18	1/16W	5%	RMC1/16 180JATP	J24185180		1-	A	E1
R 1498	CHIP RES.	18	1/16W	5%	RMC1/16 180JATP	J24185180		1-	A	E2
R 1499	CHIP RES.	4.7k	1/16W	5%	RMC1/16 472JATP	J24185472		1-	A	F2
R 1500	CHIP RES.	330	1/16W	5%	RMC1/16 331JATP	J24185331		1-	A	F6
R 1501	CHIP RES.	220	1/16W	5%	RMC1/16 221JATP	J24185221		1-	A	F3
R 1502	CHIP RES.	100k	1/16W	5%	RMC1/16 104JATP	J24185104		1-	A	C1
R 1503	CHIP RES.	680	1/16W	5%	RMC1/16 681JATP	J24185681		1-	A	E2
R 1504	CHIP RES.	680	1/16W	5%	RMC1/16 681JATP	J24185681		1-	A	E2
R 1505	CHIP RES.	680	1/16W	5%	RMC1/16 681JATP	J24185681		1-	A	E1
R 1506	CHIP RES.	680	1/16W	5%	RMC1/16 681JATP	J24185681		1-	A	E1
R 1507	CHIP RES.	10k	1/16W	5%	RMC1/16 103JATP	J24185103		1-	A	H3
R 1508	CHIP RES.	18	1/16W	5%	RMC1/16 180JATP	J24185180		1-	A	F6
R 1509	CHIP RES.	18	1/16W	5%	RMC1/16 180JATP	J24185180		1-	A	E2
R 1510	CHIP RES.	150k	1/16W	5%	RMC1/16 154JATP	J24185154		1-	A	D4
R 1511	CHIP RES.	33k	1/16W	5%	RMC1/16 333JATP	J24185333		1-	A	F3
R 1512	CHIP RES.	0	1/10W	5%	RMC1/10T 000J	J24205000		1-	A	J2
R 1513	CHIP RES.	1k	1/16W	5%	RMC1/16 102JATP	J24185102		1-	A	F2
R 1514	CHIP RES.	10k	1/16W	5%	RMC1/16 103JATP	J24185103		1-	A	F2
R 1515	CHIP RES.	1	1W	5%	RMC1 1R0JTE	J24305010		1-	A	I2
R 1516	CHIP RES.	47	1/16W	5%	RMC1/16 470JATP	J24185470		1-	A	F3
R 1517	CHIP RES.	330	1/16W	5%	RMC1/16 331JATP	J24185331		1-	A	F6
R 1518	CHIP RES.	0	1/10W	5%	RMC1/10T 000J	J24205000		1-	A	J2
R 1519	CHIP RES.	100k	1/16W	5%	RMC1/16 104JATP	J24185104		1-	A	I3
R 1520	CHIP RES.	4.7	1/16W	5%	RMC1/16 4R7JATP	J24185479		1-	A	I3
R 1521	CHIP RES.	33	1/16W	5%	RMC1/16 330JATP	J24185330		1-	A	D3
R 1522	CHIP RES.	470	1/16W	5%	RMC1/16 471JATP	J24185471		1-	A	F3
R 1523	CHIP RES.	3.3k	1/16W	5%	RMC1/16 332JATP	J24185332		1-	A	C1
R 1524	CHIP RES.	10k	1/16W	5%	RMC1/16 103JATP	J24185103		1-	A	H3
R 1525	CHIP RES.	470	1/16W	5%	RMC1/16 471JATP	J24185471		1-	A	F1
R 1526	CHIP RES.	100k	1/16W	5%	RMC1/16 104JATP	J24185104		1-	A	F1
R 1527	CHIP RES.	120	1/10W	5%	RMC1/10T 121J	J24205121		1-	A	E3
R 1528	CHIP RES.	4.7k	1/16W	5%	RMC1/16 472JATP	J24185472		1-	A	G3
R 1529	CHIP RES.	10	1/16W	5%	RMC1/16 100JATP	J24185100		1-	A	E3
R 1530	CHIP RES.	33	1/16W	5%	RMC1/16 330JATP	J24185330		1-	A	E3
R 1531	CHIP RES.	75k	1/16W	1%	RMC1/16 753FTP	J24183753		1-	A	H3
R 1532	CHIP RES.	68	1/16W	5%	RMC1/16 680JATP	J24185680		1-	A	E3
R 1533	CHIP RES.	1.8k	1/16W	5%	RMC1/16 182JATP	J24185182		1-	A	G3
R 1534	CHIP RES.	10k	1/16W	5%	RMC1/16 103JATP	J24185103		1-	A	G1
R 1535	CHIP RES.	330	1/10W	5%	RMC1/10T 331J	J24205331		1-	A	E3
R 1536	CHIP RES.	3.3k	1/16W	5%	RMC1/16 332JATP	J24185332		1-	A	G1
R 1537	CHIP RES.	33k	1/16W	1%	RMC1/16 333FTP	J24183333		1-	A	H3
R 1538	CHIP RES.	330	1/10W	5%	RMC1/10T 331J	J24205331		1-	A	E3
R 1539	CHIP RES.	470	1/16W	5%	RMC1/16 471JATP	J24185471		1-	A	G1
R 1540	CHIP RES.	4.7k	1/16W	5%	RMC1/16 472JATP	J24185472		1-	A	D1
R 1541	CHIP RES.	4.7k	1/16W	5%	RMC1/16 472JATP	J24185472		1-	A	F1
R 1542	CHIP RES.	100	1/16W	5%	RMC1/16 101JATP	J24185101		1-	A	F1
R 1543	CHIP RES.	47	1/16W	5%	RMC1/16 470JATP	J24185470		1-	A	D1
R 1544	CHIP RES.	0	1/16W	5%	RMC1/16 000JATP	J24185000		1-	A	G2
R 1545	CHIP RES.	100	1/4W	5%	RMC1/4 101JATP	J24245101		1-	A	G1
R 1546	CHIP RES.	3.3k	1/16W	1%	RMC1/16 332FTP	J24183332		1-	A	H3
R 1547	CHIP RES.	6.8k	1/16W	1%	RMC1/16 682FTP	J24183682		1-	A	H3
R 1548	CHIP RES.	1k	1/16W	5%	RMC1/16 102JATP	J24185102		1-	A	E2
R 1549	CHIP RES.	10k	1/16W	5%	RMC1/16 103JATP	J24185103		1-	A	H3
R 1550	CHIP RES.	0	1/16W	5%	RMC1/16 000JATP	J24185000		1-	A	E2
R 1551	CHIP RES.	4.7k	1/16W	5%	RMC1/16 472JATP	J24185472		1-	A	D1
R 1552	CHIP RES.	4.7k	1/16W	5%	RMC1/16 472JATP	J24185472		1-	A	G2
R 1553	CHIP RES.	100	1/16W	5%	RMC1/16 101JATP	J24185101		1-	A	E2
R 1554	CHIP RES.	33k	1/16W	5%	RMC1/16 333JATP	J24185333		1-	A	H3
R 1555	CHIP RES.	100	1/16W	5%	RMC1/16 101JATP	J24185101		1-	A	D4
R 1556	CHIP RES.	6.8k	1/16W	1%	RMC1/16 682FTP	J24183682		1-	A	H3
R 1557	CHIP RES.	4.7k	1/16W	5%	RMC1/16 472JATP	J24185472		1-	A	F2
R 1558	CHIP RES.	47	1/16W	5%	RMC1/16 470JATP	J24185470		1-	A	J4
R 1559	CHIP RES.	47	1/16W	5%	RMC1/16 470JATP	J24185470		1-	A	G3
R 1560	CHIP RES.	330	1/10W	5%	RMC1/10T 331J	J24205331		1-	A	D2
R 1561	CHIP RES.	1k	1/16W	5%	RMC1/16 102JATP	J24185102		1-	A	E4
R 1562	CHIP RES.	10k	1/16W	5%	RMC1/16 103JATP	J24185103		1-	A	G1
R 1563	CHIP RES.	100	1/16W	5%	RMC1/16 101JATP	J24185101		1-	A	F2
R 1564	CHIP RES.	1k	1/16W	5%	RMC1/16 102JATP	J24185102		1-	A	D4
R 1565	CHIP RES.	100k	1/16W	5%	RMC1/16 104JATP	J24185104		1-	A	E1
R 1566	CHIP RES.	100	1/16W	5%	RMC1/16 101JATP	J24185101		1-	A	F1
R 1567	CHIP RES.	10	1/16W	5%	RMC1/16 100JATP	J24185100		1-	A	F2

REF	DESCRIPTION	VALUE	V/W	TOL.	MFR'S DESIG	VXSTD P/N	VERS.	LOT	SIDE	LAY ADR
R 1568	CHIP RES.	6.8k	1/16W	1%	RMC1/16 682FTP	J24183682		1-	A	I3
R 1569	CHIP RES.	4.7k	1/16W	5%	RMC1/16 472JATP	J24185472		1-	A	D2
R 1570	CHIP RES.	330	1/16W	5%	RMC1/16 331JATP	J24185331		1-	A	J4
R 1571	CHIP RES.	100	1/16W	5%	RMC1/16 101JATP	J24185101		1-	A	D2
R 1572	CHIP RES.	3.3k	1/16W	5%	RMC1/16 332JATP	J24185332		1-	A	F2
R 1573	CHIP RES.	10k	1/16W	5%	RMC1/16 103JATP	J24185103		1-	A	H3
R 1574	CHIP RES.	3.9k	1/16W	1%	RMC1/16 392FTP	J24183392		1-	A	G3
R 1575	CHIP RES.	100	1/16W	5%	RMC1/16 101JATP	J24185101		1-	A	G2
R 1576	CHIP RES.	10k	1/16W	5%	RMC1/16 103JATP	J24185103		1-	A	G3
R 1577	CHIP RES.	100k	1/16W	5%	RMC1/16 104JATP	J24185104		1-	A	H3
R 1578	CHIP RES.	33k	1/16W	5%	RMC1/16 333JATP	J24185333		1-	A	H3
R 1579	CHIP RES.	47	1/16W	5%	RMC1/16 470JATP	J24185470		1-	A	G1
R 1581	CHIP RES.	33k	1/16W	5%	RMC1/16 333JATP	J24185333		1-	A	F2
R 1582	CHIP RES.	4.7k	1/16W	5%	RMC1/16 472JATP	J24185472		1-	A	G1
R 1583	CHIP RES.	100k	1/16W	5%	RMC1/16 104JATP	J24185104		1-	A	F2
R 1584	CHIP RES.	3.9k	1/16W	1%	RMC1/16 392FTP	J24183392		1-	A	G3
R 1585	CHIP RES.	47k	1/16W	5%	RMC1/16 473JATP	J24185473		1-	A	G3
R 1586	CHIP RES.	10	1/16W	5%	RMC1/16 100JATP	J24185100		1-	A	H3
R 1587	CHIP RES.	3.3k	1/16W	1%	RMC1/16 332FTP	J24183332		1-	A	H3
R 1588	CHIP RES.	330	1/16W	5%	RMC1/16 331JATP	J24185331		1-	A	I4
R 1590	CHIP RES.	10k	1/16W	5%	RMC1/16 103JATP	J24185103		1-	A	F2
R 1591	CHIP RES.	100	1/16W	5%	RMC1/16 101JATP	J24185101		1-	A	G3
R 1592	CHIP RES.	4.7k	1/16W	5%	RMC1/16 472JATP	J24185472		1-	A	G2
R 1593	CHIP RES.	1k	1/16W	5%	RMC1/16 102JATP	J24185102		1-	A	D2
R 1595	CHIP RES.	100k	1/16W	5%	RMC1/16 104JATP	J24185104		1-	A	H3
R 1596	CHIP RES.	33k	1/16W	5%	RMC1/16 333JATP	J24185333		1-	A	H3
R 1597	CHIP RES.	3.9k	1/16W	1%	RMC1/16 392FTP	J24183392		1-	A	G3
R 1598	CHIP RES.	4.7k	1/16W	5%	RMC1/16 472JATP	J24185472		1-	A	G2
R 1599	CHIP RES.	4.7k	1/16W	5%	RMC1/16 472JATP	J24185472		1-	A	E2
R 1600	CHIP RES.	68k	1/16W	5%	RMC1/16 683JATP	J24185683		1-	A	D2
R 1601	CHIP RES.	4.7k	1/16W	5%	RMC1/16 472JATP	J24185472		1-	A	C4
R 1603	CHIP RES.	220	1/16W	5%	RMC1/16 221JATP	J24185221		1-	A	F2
R 1604	CHIP RES.	2.2k	1/16W	5%	RMC1/16 222JATP	J24185222		1-	A	G3
R 1605	CHIP RES.	5.6k	1/16W	5%	RMC1/16 562JATP	J24185562		1-	A	H3
R 1606	CHIP RES.	33k	1/16W	5%	RMC1/16 333JATP	J24185333		1-	A	G3
R 1607	CHIP RES.	2.2k	1/16W	5%	RMC1/16 222JATP	J24185222		1-	A	D4
R 1611	CHIP RES.	100	1/16W	5%	RMC1/16 101JATP	J24185101		1-	A	E2
R 1613	CHIP RES.	33k	1/16W	5%	RMC1/16 333JATP	J24185333		1-	A	G3
R 1614	CHIP RES.	220	1/16W	5%	RMC1/16 221JATP	J24185221		1-	A	G1
R 1615	CHIP RES.	0	1/16W	5%	RMC1/16 000JATP	J24185000		1-	A	F2
R 1616	CHIP RES.	1k	1/16W	5%	RMC1/16 102JATP	J24185102		1-	A	G1
R 1617	CHIP RES.	10k	1/16W	5%	RMC1/16 103JATP	J24185103		1-	A	G3
R 1618	CHIP RES.	220	1/16W	5%	RMC1/16 221JATP	J24185221		1-	A	H2
R 1619	CHIP RES.	0	1/16W	5%	RMC1/16 000JATP	J24185000		1-	A	E2
R 1621	CHIP RES.	330	1/10W	5%	RMC1/10T 331J	J24205331		1-	A	D3
R 1622	CHIP RES.	330	1/4W	5%	RMC1/4 331JATP	J24245331		1-	A	G1
R 1624	CHIP RES.	1k	1/16W	5%	RMC1/16 102JATP	J24185102		1-	A	H3
R 1625	CHIP RES.	470	1/16W	5%	RMC1/16 471JATP	J24185471		1-	A	G2
R 1626	CHIP RES.	100	1/16W	5%	RMC1/16 101JATP	J24185101		1-	A	D2
R 1627	CHIP RES.	22k	1/16W	5%	RMC1/16 223JATP	J24185223		1-	A	D2
R 1628	CHIP RES.	1k	1/16W	5%	RMC1/16 102JATP	J24185102		1-	A	I3
R 1629	CHIP RES.	2.2k	1/16W	5%	RMC1/16 222JATP	J24185222		1-	A	D2
R 1630	CHIP RES.	1k	1/16W	5%	RMC1/16 102JATP	J24185102		1-	A	J2
R 1631	CHIP RES.	1k	1/16W	5%	RMC1/16 102JATP	J24185102		1-	A	I2
R 1632	CHIP RES.	1k	1/16W	5%	RMC1/16 102JATP	J24185102		1-	A	J2
R 1633	CHIP RES.	47	1/16W	5%	RMC1/16 470JATP	J24185470		1-	A	I1
R 1634	CHIP RES.	47	1/16W	5%	RMC1/16 470JATP	J24185470		1-	A	I2
R 1635	CHIP RES.	10k	1/16W	5%	RMC1/16 103JATP	J24185103	AUSTRALIA	1-	A	F1
R 1635	CHIP RES.	10k	1/16W	5%	RMC1/16 103JATP	J24185103	EUROPE	1-	A	F1
R 1635	CHIP RES.	10k	1/16W	5%	RMC1/16 103JATP	J24185103	EXPORT	1-	A	F1
R 1635	CHIP RES.	10k	1/16W	5%	RMC1/16 103JATP	J24185103	FRANCE	1-	A	F1
R 1635	CHIP RES.	6.8k	1/16W	5%	RMC1/16 682JATP	J24185682	JAPAN	1-	A	F1
R 1635	CHIP RES.	10k	1/16W	5%	RMC1/16 103JATP	J24185103	UNITED KINGDOM	1-	A	F1
R 1635	CHIP RES.	10k	1/16W	5%	RMC1/16 103JATP	J24185103	USA	1-	A	F1
R 1636	CHIP RES.	10k	1/16W	5%	RMC1/16 103JATP	J24185103	AUSTRALIA	1-	A	F1
R 1636	CHIP RES.	10k	1/16W	5%	RMC1/16 103JATP	J24185103	EUROPE	1-	A	F1
R 1636	CHIP RES.	10k	1/16W	5%	RMC1/16 103JATP	J24185103	EXPORT	1-	A	F1
R 1636	CHIP RES.	10k	1/16W	5%	RMC1/16 103JATP	J24185103	FRANCE	1-	A	F1
R 1636	CHIP RES.	6.8k	1/16W	5%	RMC1/16 682JATP	J24185682	JAPAN	1-	A	F1
R 1636	CHIP RES.	10k	1/16W	5%	RMC1/16 103JATP	J24185103	UNITED KINGDOM	1-	A	F1
R 1636	CHIP RES.	10k	1/16W	5%	RMC1/16 103JATP	J24185103	USA	1-	A	F1
R 1639	CHIP RES.	47	1/16W	5%	RMC1/16 470JATP	J24185470		1-	A	J3
R 1640	CHIP RES.	100k	1/16W	5%	RMC1/16 104JATP	J24185104		1-	A	D1

TRX Unit

Parts List

REF	DESCRIPTION	VALUE	V/W	TOL.	MFR'S DESIG	VXSTD P/N	VERS.	LOT	SIDE	LAY ADR
R 1641	CHIP RES.	10k	1/16W	5%	RMC1/16 103JATP	J24185103		1-	A	I3
R 1642	CHIP RES.	10k	1/16W	5%	RMC1/16 103JATP	J24185103		1-	A	I3
R 1643	CHIP RES.	4.7k	1/16W	5%	RMC1/16 472JATP	J24185472		1-	A	I3
R 1644	CHIP RES.	10k	1/16W	1%	RMC1/16 103FTP	J24183103		1-	A	H3
R 1645	CHIP RES.	10k	1/16W	1%	RMC1/16 103FTP	J24183103		1-	A	H3
R 1646	CHIP RES.	4.7k	1/16W	1%	RMC1/16 472FTP	J24183472		1-	A	I3
R 1647	CHIP RES.	12k	1/16W	1%	RMC1/16 123FTP	J24183123		1-	A	H3
R 1648	CHIP RES.	1k	1/16W	5%	RMC1/16 102JATP	J24185102		1-	A	H3
R 1649	CHIP RES.	47	1/16W	5%	RMC1/16 470JATP	J24185470		1-	A	H1
R 1650	CHIP RES.	68	1/16W	5%	RMC1/16 680JATP	J24185680		1-	A	F5
R 1651	CHIP RES.	1k	1/16W	5%	RMC1/16 102JATP	J24185102		1-	A	F5
R 1652	CHIP RES.	2.2k	1/10W	5%	RMC1/10T 222J	J24205222		1-	A	F5
R 1653	CHIP RES.	10k	1/16W	5%	RMC1/16 103JATP	J24185103		1-	A	G5
R 1654	CHIP RES.	47k	1/16W	5%	RMC1/16 473JATP	J24185473		1-	A	F5
R 1655	CHIP RES.	1k	1/16W	5%	RMC1/16 102JATP	J24185102		1-	A	D6
R 1656	CHIP RES.	10k	1/16W	5%	RMC1/16 103JATP	J24185103		1-	A	H2
R 1658	CHIP RES.	1k	1/16W	5%	RMC1/16 102JATP	J24185102		1-	A	C6
R 1659	CHIP RES.	4.7k	1/16W	5%	RMC1/16 472JATP	J24185472		1-	A	E1
R 1662	CHIP RES.	1k	1/16W	5%	RMC1/16 102JATP	J24185102		1-	A	F6
R 1663	CHIP RES.	470	1/16W	5%	RMC1/16 471JATP	J24185471		1-	A	E6
R 1664	CHIP RES.	100	1/10W	5%	RMC1/10T 101J	J24205101		1-	A	E6
R 1665	CHIP RES.	100	1/10W	5%	RMC1/10T 101J	J24205101		1-	A	E6
R 1667	CHIP RES.	4.7k	1/16W	5%	RMC1/16 472JATP	J24185472		1-	A	I4
R 1668	CHIP RES.	1k	1/10W	5%	RMC1/10T 102J	J24205102		1-	A	A6
R 1669	CHIP RES.	470	1/16W	5%	RMC1/16 471JATP	J24185471		1-	A	H3
R 1670	CHIP RES.	3.3	1W	5%	RMC1 3R3JTE	J24305339		4-	A	F1
R 1674	CHIP RES.	0	1/16W	5%	RMC1/16 000JATP	J24185000		14-		
R 1901	CHIP RES.	100	1/16W	5%	RMC1/16 101JATP	J24185101		1-	A	F4
R 1902	CHIP RES.	100	1/16W	5%	RMC1/16 101JATP	J24185101		1-	A	F4
R 1903	CHIP RES.	1k	1/16W	5%	RMC1/16 102JATP	J24185102		1-	A	F5
R 1904	CHIP RES.	22k	1/16W	1%	RMC1/16 223FTP	J24183223		1-	A	F4
R 1905	CHIP RES.	4.7k	1/16W	5%	RMC1/16 472JATP	J24185472		1-	A	F5
R 1906	CHIP RES.	470	1/16W	1%	RMC1/16 471FTP	J24183471		1-	A	F4
R 1907	CHIP RES.	120	1/16W	1%	RMC1/16 121FTP	J24183121		1-	A	F4
R 1908	CHIP RES.	470	1/16W	5%	RMC1/16 471JATP	J24185471		1-	A	F4
R 1909	CHIP RES.	470	1/16W	5%	RMC1/16 471JATP	J24185471		1-	A	G4
R 1910	CHIP RES.	10k	1/16W	5%	RMC1/16 103JATP	J24185103		1-	A	F4
R 1911	CHIP RES.	10k	1/16W	5%	RMC1/16 103JATP	J24185103		1-	A	G4
R 1912	CHIP RES.	3.3k	1/16W	5%	RMC1/16 332JATP	J24185332		1-	A	G4
R 1913	CHIP RES.	6.8k	1/16W	5%	RMC1/16 682JATP	J24185682		1-	A	F4
R 1914	CHIP RES.	3.3k	1/16W	5%	RMC1/16 332JATP	J24185332		1-	A	G4
R 1915	CHIP RES.	100	1/16W	5%	RMC1/16 101JATP	J24185101		1-	A	F4
R 1916	CHIP RES.	330	1/16W	5%	RMC1/16 331JATP	J24185331		1-	A	G4
R 1917	CHIP RES.	10k	1/16W	5%	RMC1/16 103JATP	J24185103		1-	A	G4
R 1918	CHIP RES.	220	1/16W	5%	RMC1/16 221JATP	J24185221		1-	A	F4
R 1919	CHIP RES.	470	1/16W	5%	RMC1/16 471JATP	J24185471		1-	A	F4
R 1920	CHIP RES.	100	1/16W	5%	RMC1/16 101JATP	J24185101		1-	A	G4
R 1921	CHIP RES.	68	1/16W	5%	RMC1/16 680JATP	J24185680		1-	A	F4
R 1922	CHIP RES.	2.2	1/16W	5%	RMC1/16 2R2JATP	J24185229		1-	A	F4
R 1923	CHIP RES.	2.2	1/16W	5%	RMC1/16 2R2JATP	J24185229		1-	A	F4
R 1924	CHIP RES.	10	1/4W	5%	RMC1/4 100JATP	J24245100		1-	A	F3
R 1925	CHIP RES.	10	1/4W	5%	RMC1/4 100JATP	J24245100		1-	A	F3
R 1926	CHIP RES.	120	1/4W	5%	RMC1/4 121JATP	J24245121		1-	A	G3
R 1927	CHIP RES.	47	1/16W	5%	RMC1/16 470JATP	J24185470		1-	A	F3
RL1001	RELAY		DC12V		FTR-B3GA012Z-B10 DC12V	M1190201		1-	A	A1
RL1002	RELAY		DC12V		FTR-B3GA012Z-B10 DC12V	M1190201		1-	A	I6
RL1003	RELAY		DC12V		FTR-B3GA012Z-B10 DC12V	M1190201		1-	A	H1
RL1004	RELAY		DC12V		FTR-B3GA012Z-B10 DC12V	M1190201		1-	A	A1
RL1005	RELAY		DC12V		FTR-B3GA012Z-B10 DC12V	M1190201		1-	A	B1
RL1006	RELAY		DC12V		FTR-B3GA012Z-B10 DC12V	M1190201		1-	A	C2
RL1007	RELAY		DC12V		FTR-B3GA012Z-B10 DC12V	M1190201		1-	A	A6
RL1008	RELAY		DC12V		FTR-B3GA012Z-B10 DC12V	M1190201		1-	A	B6
RL1009	RELAY		DC12V		FTR-B3GA012Z-B10 DC12V	M1190201		1-	A	I4
RL1010	RELAY		DC12V		G5V-1 DC12V	M1190120		1-7	A	G1
RL1010	RELAY		DC12V		G6J-2P-Y DC12V	M1190190	W/ CE LABEL	8-	A	G1
RL1010	RELAY		DC12V		G5V-1 DC12V	M1190120	W/O CE LABEL	8-	A	G1
RL1010	RELAY		DC12V		G6J-2P-Y DC12V	M1190190	W/O CE LABEL	11-	A	G1
RL1011	RELAY		DC12V		FTR-B3GA012Z-B10 DC12V	M1190201		1-	A	G1
S 1001	SLIDE SWITCH				SSSS222700	N6090057		1-	A	G1
T 1001	BALUN TRANSFORMERS				#458PT-1565	L0190273		1-	A	H6
T 1002	BALUN TRANSFORMERS				#458PT-1565	L0190273		1-	A	H6
T 1003	BALUN TRANSFORMERS				070812735D	L0023046		1-	A	I6
T 1004	COIL 07RF	160MHZ			160M R12-K905X	L0022053		1-	A	G6

TRX Unit

Parts List

REF	DESCRIPTION	VALUE	V/W	TOL.	MFR'S DESIG	VXSTD P/N	VERS.	LOT	SIDE	LAY ADR
T 1005	BALUN TRANSFOMERS				#458PT-1565	L0190273		1-	A	F5
T 1006	BALUN TRANSFOMERS				#458PT-1565	L0190273		1-	A	E5
T 1007	COIL 07RF	73.62MHz			73.62M S-135-214	L0021960		1-	A	F4
T 1008	COIL WIDE-TRANS.				050812564 92H5	L0022619		1-	A	B6
T 1009	COIL WIDE-TRANS.				050812564 92H5	L0022619		1-	A	A6
T 1010	COIL 07RF	73.62MHz			73.62M S-135-214	L0021960		1-	A	E4
T 1011	COIL 07RF	73.62MHz			73.62M S-135-214	L0021960		1-	A	E4
T 1012	COIL 07RF	160MHz			160M R12-K906X	L0022056		1-	A	B6
T 1013	BALUN TRANSFOMERS				070812735D	L0023046		1-	A	C6
T 1014	BALUN TRANSFOMERS				070812736D	L0023047		1-	A	E6
T 1015	BALUN TRANSFOMERS				070812735D	L0023046		1-	A	D6
T 1016	BALUN TRANSFOMERS				080812771A	L0023078		1-	A	H2
T 1017	COIL 07RF	73.62MHz			73.62M S-135-214	L0021960		1-	A	F4
T 1018	BALUN TRANSFOMERS				070812737B	L0023048		1-	A	D6
T 1019	COIL 07RF	40.455MHz			#223229	L0022919		1-	A	D3
T 1020	BALUN TRANSFOMERS				070812735D	L0023046		1-	A	C6
T 1021	BALUN TRANSFOMERS				080812771A	L0023078		1-	A	H2
T 1022	COIL 07RF	40.455MHz			M7-T1 R-12W083A	L0022920		1-	A	C5
T 1023	COIL RF				R12*7935A	L0020421		1-	A	G2
T 1024	COIL 07RF	73.62MHz			73.62M S-135-214	L0021960		1-	A	F3
T 1025	COIL WIDE-TRANS.				050812564 92H5	L0022619		1-	A	D5
T 1026	COIL 07RF	40.455MHz			#223229	L0022919		1-	A	D4
T 1027	COIL 07RF	40.455MHz			M7-T1 R-12W083A	L0022920		1-	A	D5
T 1028	COIL 07RF	455kHz			#223227	L0022917		1-	A	E2
T 1029	COIL 07RF	40.455MHz			M7-T1 R-12W081A	L0022918		1-	A	D3
T 1030	COIL 07RF	40.455MHz			#223229	L0022919		1-	A	E3
T 1031	BALUN TRANSFOMERS				070812735D	L0023046		1-	A	D4
T 1032	BALUN TRANSFOMERS				070812735D	L0023046		1-	A	E2
T 1033	BALUN TRANSFOMERS				070812736D	L0023047		1-	A	D4
T 1034	COIL 07RF	40.455MHz			M7-T1 R-12W083A	L0022920		1-	A	E3
T 1035	COIL 07RF	40.455MHz			#223229	L0022919		1-	A	E3
T 1036	COIL 07RF	40.455MHz			M7-T1 R-12W081A	L0022918		1-	A	D3
T 1037	COIL 07RF	47MHz			47.0M	L0021546		1-	A	F2
T 1038	COIL 07RF	40.455MHz			M7-T1 R-12W081A	L0022918		1-	A	D4
T 1039	COIL 07RF	455kHz			#223227	L0022917		1-	A	H3
T 1040	COIL 07RF	47.1MHz			47.1M R12-M411A	L0021225		1-	A	E2
T 1041	BALUN TRANSFOMERS				070812737B	L0023048		1-	A	D4
T 1042	BALUN TRANSFOMERS				070812737B	L0023048		1-	A	C5
T 1043	BALUN TRANSFOMERS				#458PT-1586	L0190276		1-	A	E6
TP1002	CHECK TERMINAL				RCT00000C	Q5000103		1-	A	H6
TP1005	CHECK TERMINAL				RCT00000C	Q5000103		1-	A	G6
TP1021	CHECK TERMINAL				RCT00000C	Q5000103		1-	A	C6
TP1023	CHECK TERMINAL				RCT00000C	Q5000103		1-	A	D2
TP1027	CHECK TERMINAL				RCT00000C	Q5000103		1-	A	H5
TP1028	CHECK TERMINAL				RCT00000C	Q5000103		1-	A	H5
TP1030	CHECK TERMINAL				RCT00000C	Q5000103		1-	A	E4
TP1037	CHECK TERMINAL				RCT00000C	Q5000103		1-	A	D6
TP1039	CHECK TERMINAL				RCT00000C	Q5000103		1-	A	G5
TP1040	CHECK TERMINAL				RCT00000C	Q5000103		1-	A	E3
TP1043	CHECK TERMINAL				RCT00000C	Q5000103		1-	A	D4
TP1044	CHECK TERMINAL				RCT00000C	Q5000103		1-	A	F2
TP1045	CHECK TERMINAL				RCT00000C	Q5000103		1-	A	G3
TP1048	CHECK TERMINAL				RCT00000C	Q5000103		1-	A	H2
TP1061	CHECK TERMINAL				RCT00000C	Q5000103		1-	A	J5
XF1001	XTAL FILTER				MFT40R2 40.455MHz 15kHz	H1102386		1-	A	C5
XF1002	XTAL FILTER				MFT40R2 40.455MHz 15kHz	H1102386		1-	A	F3
XF1003	XTAL FILTER				MFT40L 40.455MHz 6kHz	H1102387		1-	A	E3
XF1004	XTAL FILTER				MFT40F 40.455MHz 3kHz	H1102388		1-	A	D3
XF1005	MECHANICAL FILTER				XF-119S	H2900004		1-	A	F2
	SHIELD CASE				(20X51)	RA0830700		1-		
	SHIELD CASE COVER				(20X51)	RA0830800		1-		
	SHIELD CASE					RA0659300		1-		
	SHIELD CASE COVER				(37x30.5)	RA1152400		1-		
	SHIELD CASE				(45x43.5)	RA1152000		1-		
	SHIELD CASE COVER				(45x43.5)	RA1152100		1-		
	SHIELD CASE				(28x15)	RA1152200		1-		
	SHIELD CASE COVER				(28x15)	RA1152300		1-		
	COVER				(P1090823)	RA1258000	W/ CE LABEL	8-		
	COVER				(8PIN)	RA1258100	W/ CE LABEL	8-		
	COVER				(N6090057)	RA1267800	W/ CE LABEL	8-		
	COVER				(3.5D-3)	RA1258200	W/ CE LABEL	8-		
	COVER				(P1091132)	RA1266800	W/ CE LABEL	8-		

TRX Unit

Note:

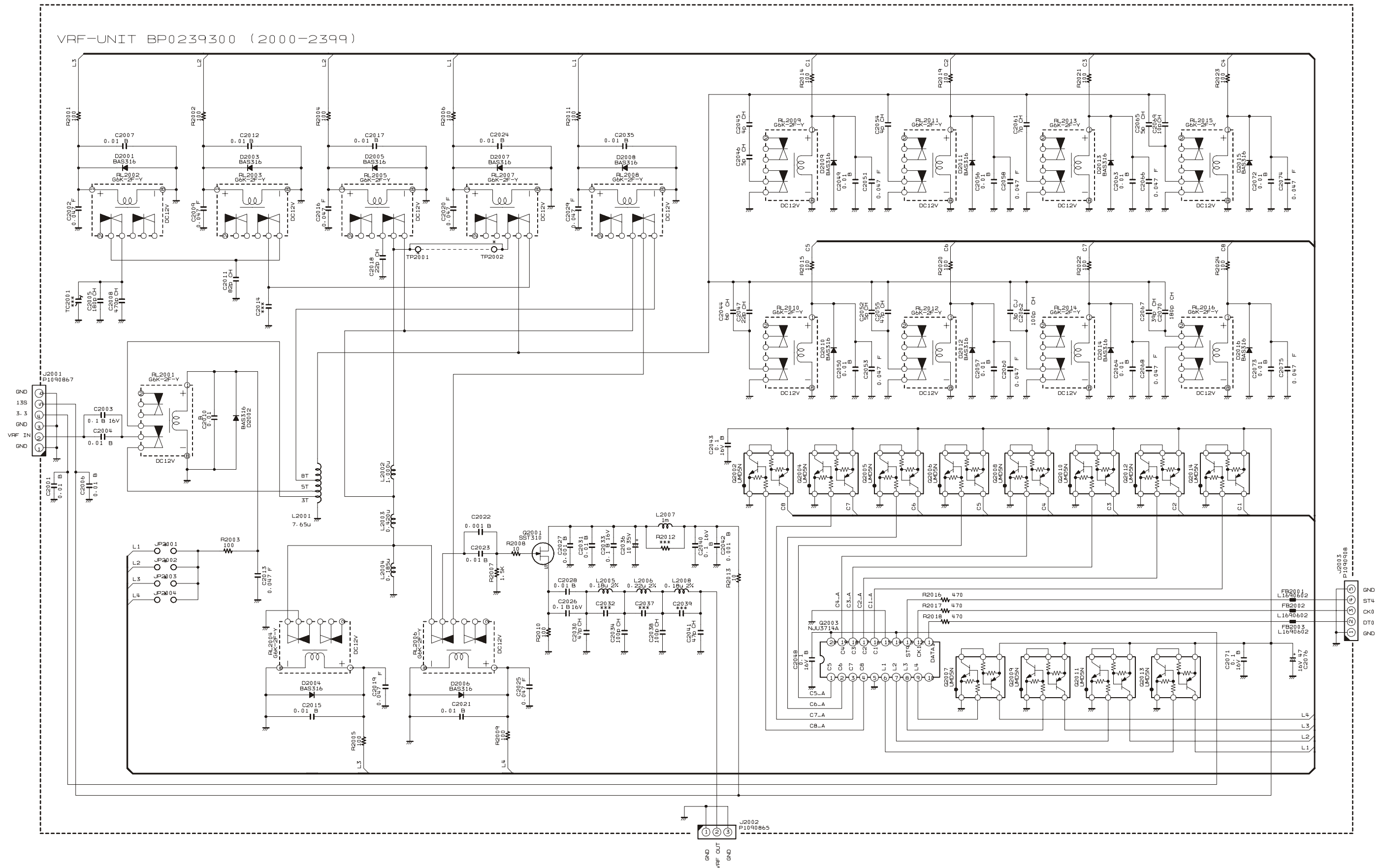

VRF Unit (VFO-B)

Parts Layout

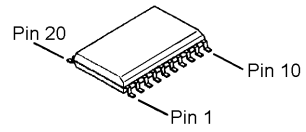

NJU3714A
(Q2003)

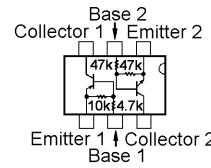

UMD5N
(Q2002, 2004, 2005,
2006, 2007, 2008,
2009, 2010, 2011,
2012, 2013, 2014)

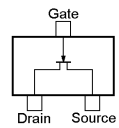

SST310 (Z0)
(Q2001)

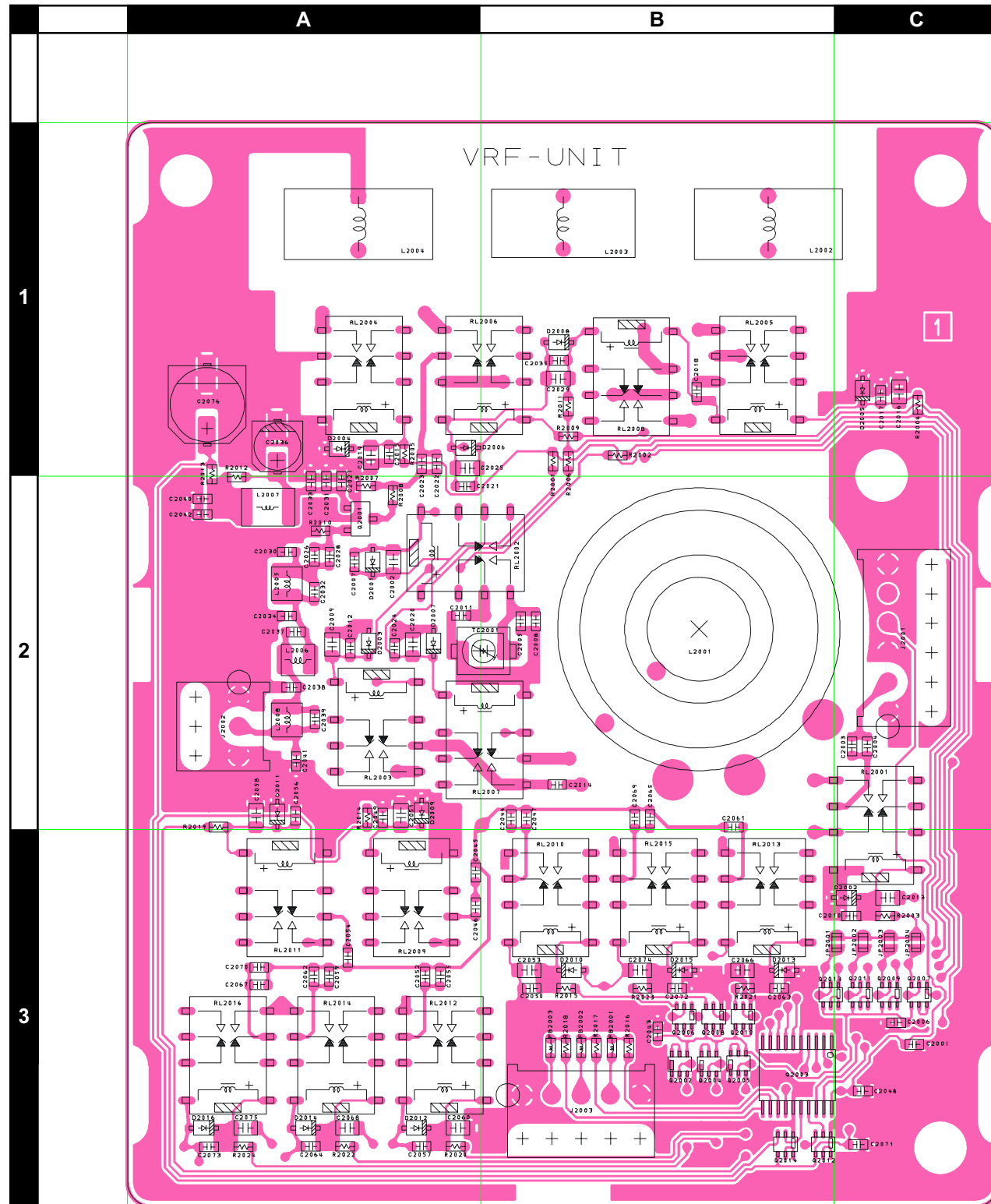

Side A

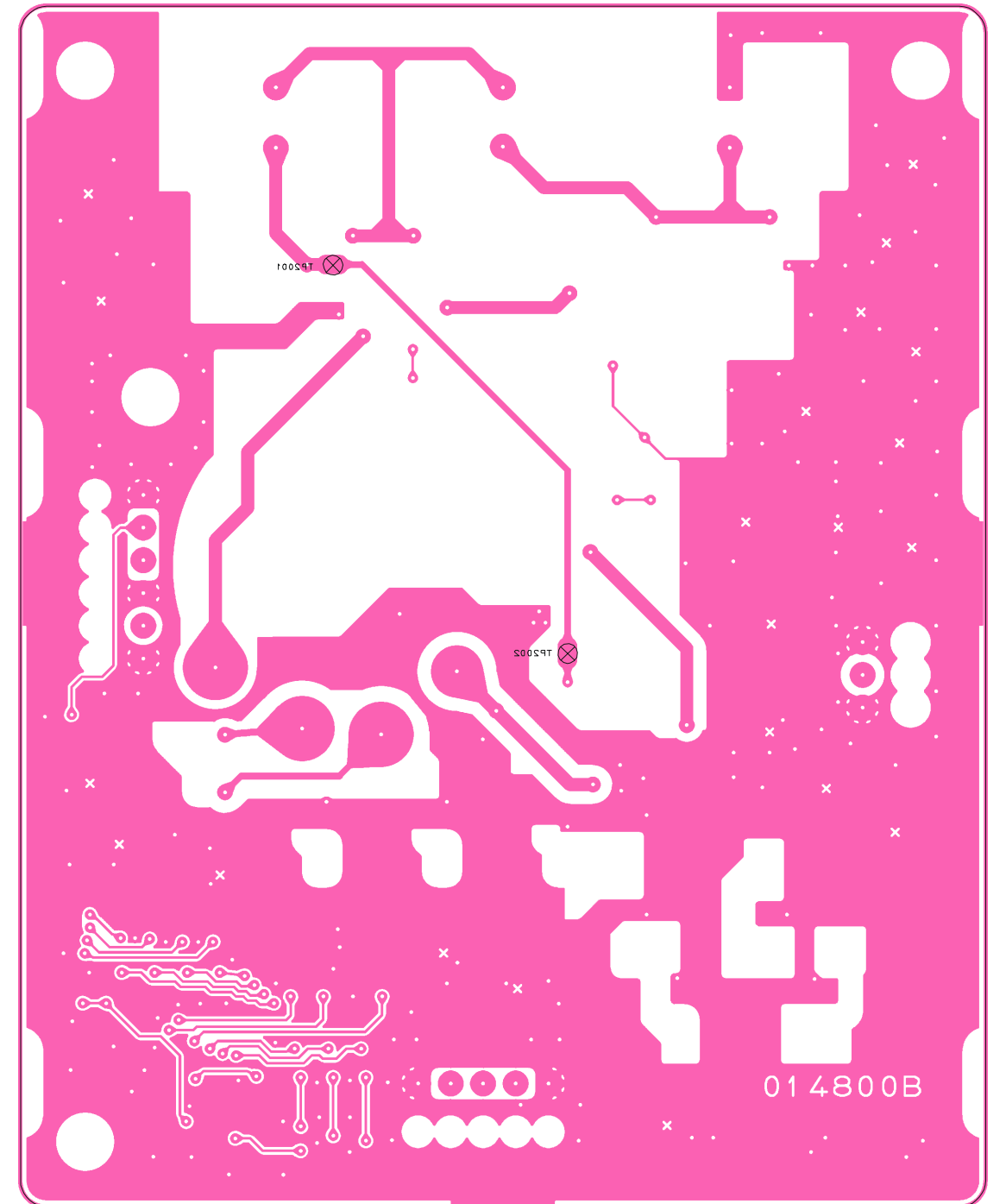

Side B

VRF Unit (VFO-B)

Parts List

REF	DESCRIPTION	VALUE	V/W	TOL.	MFR'S DESIG	VXSTD P/N	VERS.	LOT	SIDE	LAY ADR
PCB with Components						CS2072501				
	Printed Circuit Board					FR014800B		1-	A	D4
C 2001	CHIP CAP.	0.01uF	50V	B	GRM188B11H103KA01D	K22174823		1-	A	D4
C 2002	CHIP CAP.	0.047uF	50V	F	GRM40F473Z50PT	K22171008		1-	A	B2
C 2003	CHIP CAP.	0.1uF	16V	B	GRM188B11C104KA01D	K22124805		1-	A	D3
C 2004	CHIP CAP.	0.01uF	50V	B	GRM188B11H103KA01D	K22174823		1-	A	D3
C 2005	CHIP CAP.	180pF	50V	CH	GRM1882C1H181JA01D	K22174241		1-	A	B3
C 2006	CHIP CAP.	0.01uF	50V	B	GRM188B11H103KA01D	K22174823		1-	A	D4
C 2007	CHIP CAP.	0.01uF	50V	B	GRM188B11H103KA01D	K22174823		1-	A	A2
C 2008	CHIP CAP.	470pF	50V	CH	GRM1882C1H471JA01D	K22174249		1-	A	B3
C 2009	CHIP CAP.	0.047uF	50V	F	GRM40F473Z50PT	K22171008		1-	A	A3
C 2010	CHIP CAP.	0.01uF	50V	B	GRM188B11H103KA01D	K22174823		1-	A	D4
C 2011	CHIP CAP.	82pF	50V	CH	GRM1882C1H820JA01D	K22174233		1-	A	B3
C 2012	CHIP CAP.	0.01uF	50V	B	GRM188B11H103KA01D	K22174823		1-	A	A3
C 2013	CHIP CAP.	0.047uF	50V	F	GRM40F473Z50PT	K22171008		1-	A	D4
C 2015	CHIP CAP.	0.01uF	50V	B	GRM188B11H103KA01D	K22174823		1-	A	B2
C 2016	CHIP CAP.	0.047uF	50V	F	GRM40F473Z50PT	K22171008		1-	A	D2
C 2017	CHIP CAP.	0.01uF	50V	B	GRM188B11H103KA01D	K22174823		1-	A	D2
C 2018	CHIP CAP.	22pF	50V	CH	GRM1882C1H220JA01D	K22174219		1-	A	C2
C 2019	CHIP CAP.	0.047uF	50V	F	GRM40F473Z50PT	K22171008		1-	A	B2
C 2020	CHIP CAP.	0.047uF	50V	F	GRM40F473Z50PT	K22171008		1-	A	B3
C 2021	CHIP CAP.	0.01uF	50V	B	GRM188B11H103KA01D	K22174823		1-	A	B2
C 2022	CHIP CAP.	0.001uF	50V	B	GRM188B11H102KA01D	K22174821		1-	A	B2
C 2023	CHIP CAP.	0.01uF	50V	B	GRM188B11H103KA01D	K22174823		1-	A	B2
C 2024	CHIP CAP.	0.01uF	50V	B	GRM188B11H103KA01D	K22174823		1-	A	B3
C 2025	CHIP CAP.	0.047uF	50V	F	GRM40F473Z50PT	K22171008		1-	A	B2
C 2026	CHIP CAP.	0.1uF	16V	B	GRM188B11C104KA01D	K22124805		1-	A	A2
C 2027	CHIP CAP.	0.001uF	50V	B	GRM188B11H102KA01D	K22174821		1-	A	A2
C 2028	CHIP CAP.	0.01uF	50V	B	GRM188B11H103KA01D	K22174823		1-	A	A2
C 2029	CHIP CAP.	0.047uF	50V	F	GRM40F473Z50PT	K22171008		1-	A	B2
C 2030	CHIP CAP.	47pF	50V	CH	GRM1882C1H470JA01D	K22174227		1-	A	A2
C 2031	CHIP CAP.	0.01uF	50V	B	GRM188B11H103KA01D	K22174823		1-	A	A2
C 2033	CHIP CAP.	0.1uF	16V	B	GRM188B11C104KA01D	K22124805		1-	A	A2
C 2034	CHIP CAP.	100pF	50V	CH	GRM1882C1H101JA01D	K22174235		1-	A	A3
C 2035	CHIP CAP.	0.01uF	50V	B	GRM188B11H103KA01D	K22174823		1-	A	B2
C 2036	AL.ELECTRO.CAP.	10uF	35V		EEE1VA100WR	K48160006		1-	A	A2
C 2038	CHIP CAP.	100pF	50V	CH	GRM1882C1H101JA01D	K22174235		1-	A	A3
C 2040	CHIP CAP.	0.1uF	16V	B	GRM188B11C104KA01D	K22124805		1-	A	A2
C 2041	CHIP CAP.	47pF	50V	CH	GRM1882C1H470JA01D	K22174227		1-	A	A3
C 2042	CHIP CAP.	0.001uF	50V	B	GRM188B11H102KA01D	K22174821		1-	A	A2
C 2043	CHIP CAP.	0.1uF	16V	B	GRM188B11C104KA01D	K22124805		1-	A	C4
C 2044	CHIP CAP.	6pF	50V	CH	GRM1882C1H6R0DZ01D	K22174207		1-	A	B3
C 2045	CHIP CAP.	4pF	50V	CH	GRM1882C1H4R0CZ01D	K22174205		1-	A	B4
C 2046	CHIP CAP.	5pF	50V	CH	GRM1882C1H5R0CZ01D	K22174206		1-	A	B4
C 2047	CHIP CAP.	22pF	50V	CH	GRM1882C1H220JA01D	K22174219		1-	A	B3
C 2048	CHIP CAP.	0.1uF	16V	B	GRM188B11C104KA01D	K22124805		1-	A	D5
C 2049	CHIP CAP.	0.01uF	50V	B	GRM188B11H103KA01D	K22174823		1-	A	B3
C 2050	CHIP CAP.	0.01uF	50V	B	GRM188B11H103KA01D	K22174823		1-	A	B4
C 2051	CHIP CAP.	0.047uF	50V	F	GRM40F473Z50PT	K22171008		1-	A	B3
C 2052	CHIP CAP.	5pF	50V	CH	GRM1882C1H5R0CZ01D	K22174206		1-	A	B4
C 2053	CHIP CAP.	0.047uF	50V	F	GRM40F473Z50PT	K22171008		1-	A	B4
C 2054	CHIP CAP.	4pF	50V	CH	GRM1882C1H4R0CZ01D	K22174205		1-	A	A4
C 2055	CHIP CAP.	47pF	50V	CH	GRM1882C1H470JA01D	K22174227		1-	A	B4
C 2056	CHIP CAP.	0.01uF	50V	B	GRM188B11H103KA01D	K22174823		1-	A	A3
C 2057	CHIP CAP.	0.01uF	50V	B	GRM188B11H103KA01D	K22174823		1-	A	B5
C 2058	CHIP CAP.	0.047uF	50V	F	GRM40F473Z50PT	K22171008		1-	A	A3
C 2059	CHIP CAP.	3pF	50V	CJ	GRM1883C1H3R0CZ01D	K22174204		1-	A	A4
C 2060	CHIP CAP.	0.047uF	50V	F	GRM40F473Z50PT	K22171008		1-	A	B5
C 2061	CHIP CAP.	7pF	50V	CH	GRM1882C1H7R0DZ01D	K22174208		1-	A	C3
C 2062	CHIP CAP.	100pF	50V	CH	GRM1882C1H101JA01D	K22174235		1-	A	A4
C 2063	CHIP CAP.	0.01uF	50V	B	GRM188B11H103KA01D	K22174823		1-	A	C4
C 2064	CHIP CAP.	0.01uF	50V	B	GRM188B11H103KA01D	K22174823		1-	A	A5
C 2065	CHIP CAP.	5pF	50V	CH	GRM1882C1H5R0CZ01D	K22174206		1-	A	C3
C 2066	CHIP CAP.	0.047uF	50V	F	GRM40F473Z50PT	K22171008		1-	A	C4
C 2067	CHIP CAP.	39pF	50V	CH	GRM1882C1H390JA01D	K22174225		1-	A	A4
C 2068	CHIP CAP.	0.047uF	50V	F	GRM40F473Z50PT	K22171008		1-	A	A5
C 2069	CHIP CAP.	10pF	50V	CH	GRM1882C1H100JA01D	K22174211		1-	A	C3
C 2070	CHIP CAP.	180pF	50V	CH	GRM1882C1H181JA01D	K22174241		1-	A	A4
C 2071	CHIP CAP.	0.1uF	16V	B	GRM188B11C104KA01D	K22124805		1-	A	D5
C 2072	CHIP CAP.	0.01uF	50V	B	GRM188B11H103KA01D	K22174823		1-	A	C4
C 2073	CHIP CAP.	0.01uF	50V	B	GRM188B11H103KA01D	K22174823		1-	A	A5
C 2074	CHIP CAP.	0.047uF	50V	F	GRM40F473Z50PT	K22171008		1-	A	C4
C 2075	CHIP CAP.	0.047uF	50V	F	GRM40F473Z50PT	K22171008		1-	A	A5

VRF Unit (VFO-B)

Parts List

REF	DESCRIPTION	VALUE	V/W	TOL.	MFR'S DESIG	VXSTD P/N	VERS.	LOT	SIDE	LAY ADR
C 2076	AL.ELECTRO.CAP.	47uF	16V		EEE1CA470SP	K48120005		1-	A	A2
D 2001	DIODE				BAS316	G2070716		1-	A	B2
D 2002	DIODE				BAS316	G2070716		1-	A	D4
D 2003	DIODE				BAS316	G2070716		1-	A	B3
D 2004	DIODE				BAS316	G2070716		1-	A	A2
D 2005	DIODE				BAS316	G2070716		1-	A	D2
D 2006	DIODE				BAS316	G2070716		1-	A	B2
D 2007	DIODE				BAS316	G2070716		1-	A	B3
D 2008	DIODE				BAS316	G2070716		1-	A	B1
D 2009	DIODE				BAS316	G2070716		1-	A	B3
D 2010	DIODE				BAS316	G2070716		1-	A	B4
D 2011	DIODE				BAS316	G2070716		1-	A	A3
D 2012	DIODE				BAS316	G2070716		1-	A	B5
D 2013	DIODE				BAS316	G2070716		1-	A	C4
D 2014	DIODE				BAS316	G2070716		1-	A	A5
D 2015	DIODE				BAS316	G2070716		1-	A	C4
D 2016	DIODE				BAS316	G2070716		1-	A	A5
FB2001	FERRITE BEADS				BLM18BD182SN1D	L1690602		1-	A	C4
FB2002	FERRITE BEADS				BLM18BD182SN1D	L1690602		1-	A	B4
FB2003	FERRITE BEADS				BLM18BD182SN1D	L1690602		1-	A	B4
J 2001	CONNECTOR				IMSA-9133S-06D	P1090867		1-	A	D3
J 2002	CONNECTOR				IMSA-9133S-03D	P1090865		1-	A	A3
J 2003	CONNECTOR				IMSA-9133S-05D	P1090908		1-	A	B5
L 2001	TOROIDAL COIL	7.65uH			7.65U T80-2	L0022848A		1-	A	C3
L 2002	TOROIDAL COIL	1uH			1.000U T37-6 AMIDON	L0021571		1-	A	C1
L 2003	TOROIDAL COIL	0.42uH			0.420U T37-6 AMIDON	L0021575B		1-	A	B1
L 2004	TOROIDAL COIL	0.185uH			0.185U T37-10	L0022981		1-	A	A1
L 2005	CHIP COIL	0.18uH		2%	C2520C-R18G-RA	L1691297		1-	A	A2
L 2006	CHIP COIL	0.22uH		2%	C2520C-R22G-RA	L1691298		1-	A	A3
L 2007	CHIP COIL	1mH			LQH43MN102K03L	L1690108		1-	A	A2
L 2008	CHIP COIL	0.18uH		2%	C2520C-R18G-RA	L1691297		1-	A	A3
Q 2001	FET				SST310-T1	G4070009		1-	A	A2
Q 2002	TRANSISTOR				UMD5N TR	G3070343		1-	A	C4
Q 2003	IC				NJU3714A(TAPE)	G1094291		1-	A	C5
Q 2004	TRANSISTOR				UMD5N TR	G3070343		1-	A	C4
Q 2005	TRANSISTOR				UMD5N TR	G3070343		1-	A	C4
Q 2006	TRANSISTOR				UMD5N TR	G3070343		1-	A	C4
Q 2007	TRANSISTOR				UMD5N TR	G3070343		1-	A	D4
Q 2008	TRANSISTOR				UMD5N TR	G3070343		1-	A	C4
Q 2009	TRANSISTOR				UMD5N TR	G3070343		1-	A	D4
Q 2010	TRANSISTOR				UMD5N TR	G3070343		1-	A	C4
Q 2011	TRANSISTOR				UMD5N TR	G3070343		1-	A	D4
Q 2012	TRANSISTOR				UMD5N TR	G3070343		1-	A	C5
Q 2013	TRANSISTOR				UMD5N TR	G3070343		1-	A	C4
Q 2014	TRANSISTOR				UMD5N TR	G3070343		1-	A	C5
R 2001	CHIP RES.	100	1/16W	5%	RMC1/16 101JATP	J24185101		1-	A	B2
R 2002	CHIP RES.	100	1/16W	5%	RMC1/16 101JATP	J24185101		1-	A	C2
R 2003	CHIP RES.	100	1/16W	5%	RMC1/16 101JATP	J24185101		1-	A	D4
R 2004	CHIP RES.	100	1/16W	5%	RMC1/16 101JATP	J24185101		1-	A	D2
R 2005	CHIP RES.	100	1/16W	5%	RMC1/16 101JATP	J24185101		1-	A	B2
R 2006	CHIP RES.	100	1/16W	5%	RMC1/16 101JATP	J24185101		1-	A	B2
R 2007	CHIP RES.	1.5k	1/16W	5%	RMC1/16 152JATP	J24185152		1-	A	B2
R 2008	CHIP RES.	10	1/16W	5%	RMC1/16 100JATP	J24185100		1-	A	B2
R 2009	CHIP RES.	100	1/16W	5%	RMC1/16 101JATP	J24185101		1-	A	B2
R 2010	CHIP RES.	100	1/16W	5%	RMC1/16 101JATP	J24185101		1-	A	A2
R 2011	CHIP RES.	100	1/16W	5%	RMC1/16 101JATP	J24185101		1-	A	B2
R 2013	CHIP RES.	10	1/16W	5%	RMC1/16 100JATP	J24185100		1-	A	A2
R 2014	CHIP RES.	100	1/16W	5%	RMC1/16 101JATP	J24185101		1-	A	B3
R 2015	CHIP RES.	100	1/16W	5%	RMC1/16 101JATP	J24185101		1-	A	B4
R 2016	CHIP RES.	470	1/16W	5%	RMC1/16 471JATP	J24185471		1-	A	C4
R 2017	CHIP RES.	470	1/16W	5%	RMC1/16 471JATP	J24185471		1-	A	B4
R 2018	CHIP RES.	470	1/16W	5%	RMC1/16 471JATP	J24185471		1-	A	B4
R 2019	CHIP RES.	100	1/16W	5%	RMC1/16 101JATP	J24185101		1-	A	A3
R 2020	CHIP RES.	100	1/16W	5%	RMC1/16 101JATP	J24185101		1-	A	B5
R 2021	CHIP RES.	100	1/16W	5%	RMC1/16 101JATP	J24185101		1-	A	C4
R 2022	CHIP RES.	100	1/16W	5%	RMC1/16 101JATP	J24185101		1-	A	A5
R 2023	CHIP RES.	100	1/16W	5%	RMC1/16 101JATP	J24185101		1-	A	C4
R 2024	CHIP RES.	100	1/16W	5%	RMC1/16 101JATP	J24185101		1-	A	A5
RL2001	RELAY		DC12V		G6K-2F-Y-TR DC12V	M1190183		1-	A	D3
RL2002	RELAY		DC12V		G6K-2F-Y-TR DC12V	M1190183		1-	A	B2
RL2003	RELAY		DC12V		G6K-2F-Y-TR DC12V	M1190183		1-	A	B3
RL2004	RELAY		DC12V		G6K-2F-Y-TR DC12V	M1190183		1-	A	B2
RL2005	RELAY		DC12V		G6K-2F-Y-TR DC12V	M1190183		1-	A	C2

VRF Unit (VFO-B)

Parts List

REF	DESCRIPTION	VALUE	V/W	TOL.	MFR'S DESIG	VXSTD P/N	VERS.	LOT	SIDE	LAY ADR
RL2006	RELAY		DC12V		G6K-2F-Y-TR DC12V	M1190183		1-	A	B2
RL2007	RELAY		DC12V		G6K-2F-Y-TR DC12V	M1190183		1-	A	B3
RL2008	RELAY		DC12V		G6K-2F-Y-TR DC12V	M1190183		1-	A	C2
RL2009	RELAY		DC12V		G6K-2F-Y-TR DC12V	M1190183		1-	A	B4
RL2010	RELAY		DC12V		G6K-2F-Y-TR DC12V	M1190183		1-	A	B4
RL2011	RELAY		DC12V		G6K-2F-Y-TR DC12V	M1190183		1-	A	A4
RL2012	RELAY		DC12V		G6K-2F-Y-TR DC12V	M1190183		1-	A	B4
RL2013	RELAY		DC12V		G6K-2F-Y-TR DC12V	M1190183		1-	A	C4
RL2014	RELAY		DC12V		G6K-2F-Y-TR DC12V	M1190183		1-	A	A4
RL2015	RELAY		DC12V		G6K-2F-Y-TR DC12V	M1190183		1-	A	C4
RL2016	RELAY		DC12V		G6K-2F-Y-TR DC12V	M1190183		1-	A	A4
	SHIELD CASE COVER				(74X92)	RA083090A		1-		

VRF Unit (VFO-B)

Note:

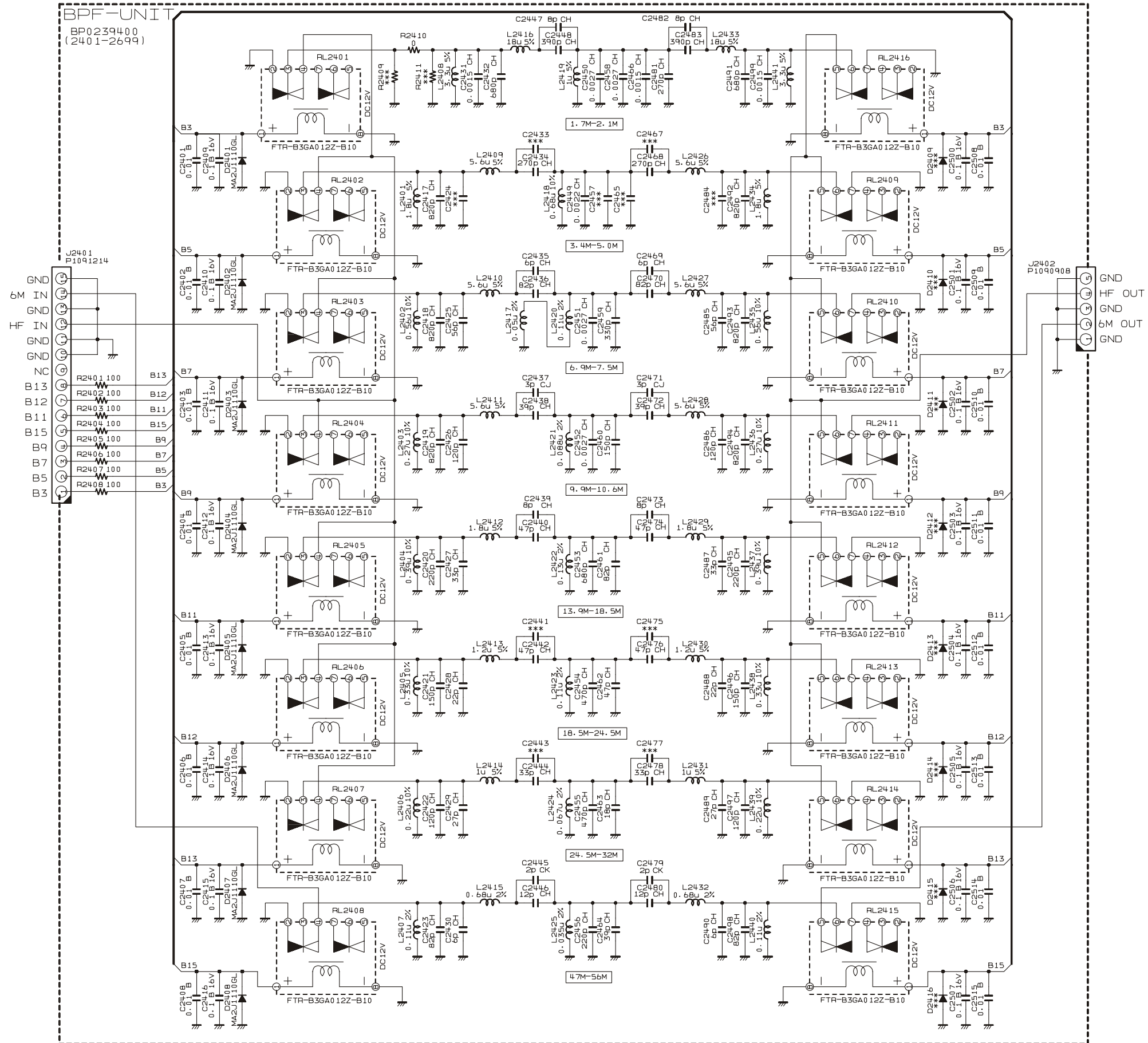

BPF Unit

Note

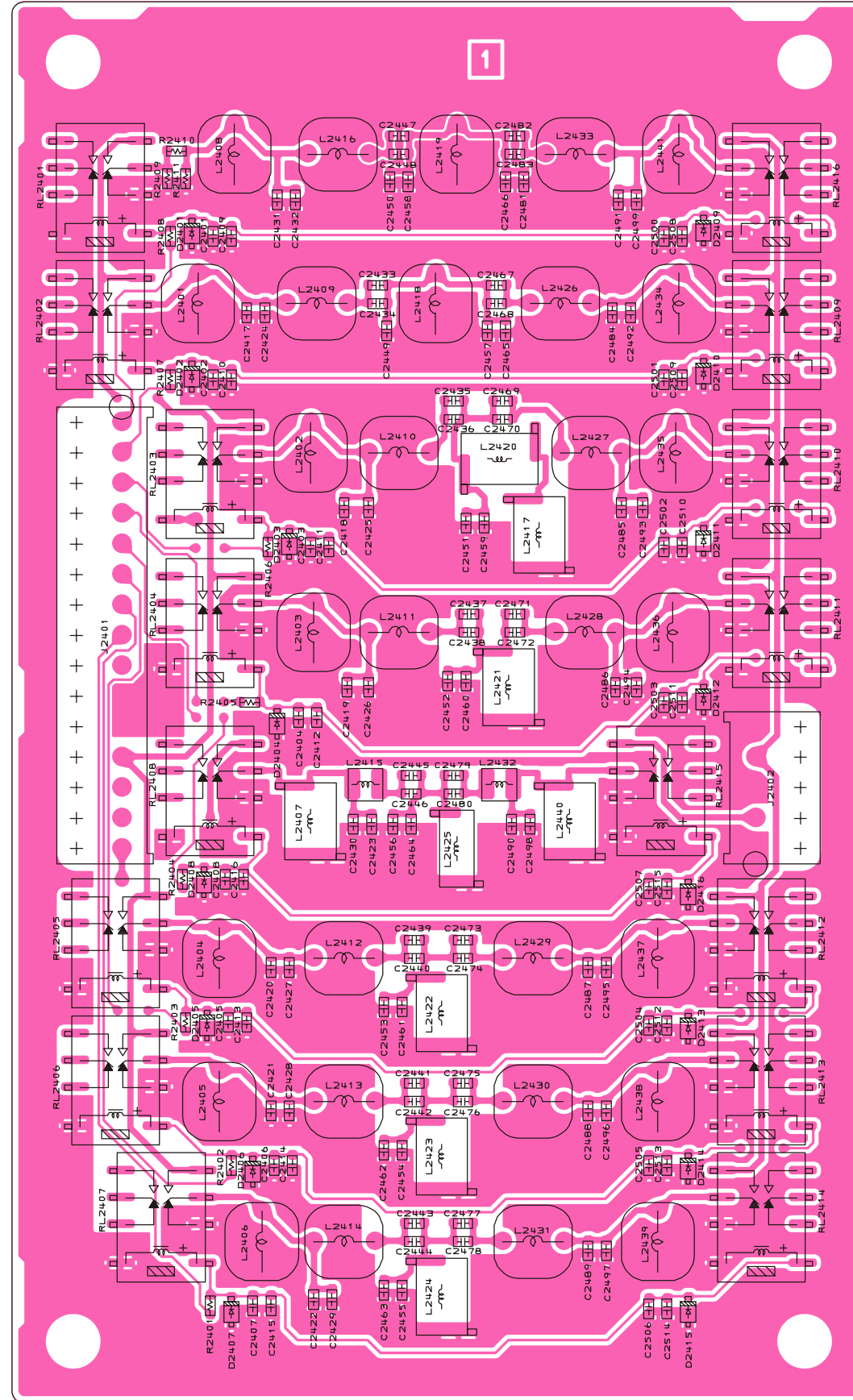

BPF Unit

Parts Layout (Side B)

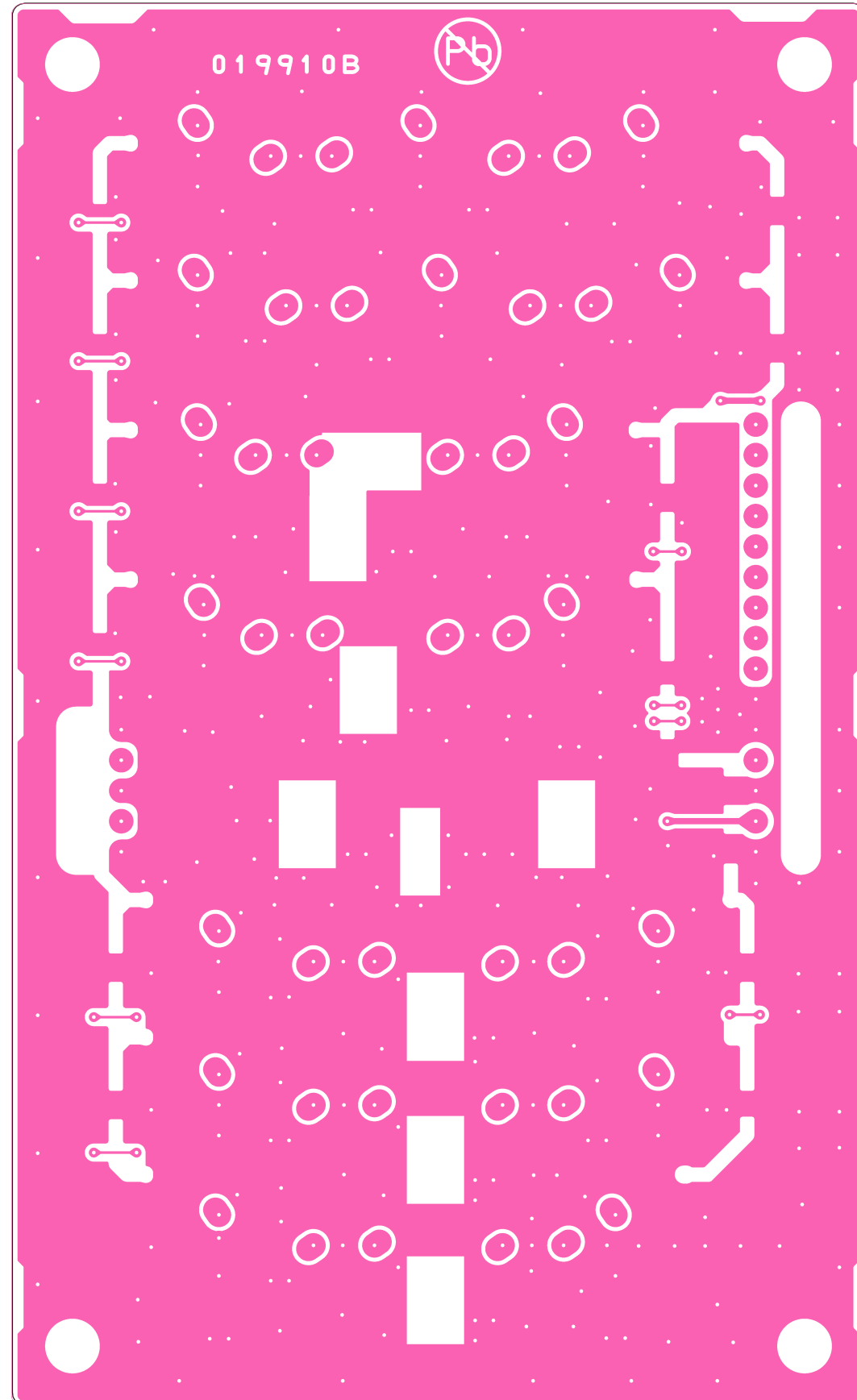

BPF Unit

Parts List

REF	DESCRIPTION	VALUE	V/W	TOL.	MFR'S DESIG	VXSTD P/N	VERS.	LOT	SIDE	LAY ADR
	PCB with Components					CS2077501				
	Printed Circuit Board					FR019910B		1-		
C 2401	CHIP CAP.	0.01uF	50V	B	GRM188B11H103KA01D	K22174823		1-	A	A1
C 2402	CHIP CAP.	0.01uF	50V	B	GRM188B11H103KA01D	K22174823		1-	A	A2
C 2403	CHIP CAP.	0.01uF	50V	B	GRM188B11H103KA01D	K22174823		1-	A	B3
C 2404	CHIP CAP.	0.01uF	50V	B	GRM188B11H103KA01D	K22174823		1-	A	B3
C 2405	CHIP CAP.	0.01uF	50V	B	GRM188B11H103KA01D	K22174823		1-	A	A5
C 2406	CHIP CAP.	0.01uF	50V	B	GRM188B11H103KA01D	K22174823		1-	A	B5
C 2407	CHIP CAP.	0.01uF	50V	B	GRM188B11H103KA01D	K22174823		1-	A	A6
C 2408	CHIP CAP.	0.01uF	50V	B	GRM188B11H103KA01D	K22174823		1-	A	A4
C 2409	CHIP CAP.	0.1uF	16V	B	GRM188B11C104KA01D	K22124805		1-	A	A1
C 2410	CHIP CAP.	0.1uF	16V	B	GRM188B11C104KA01D	K22124805		1-	A	A2
C 2411	CHIP CAP.	0.1uF	16V	B	GRM188B11C104KA01D	K22124805		1-	A	B3
C 2412	CHIP CAP.	0.1uF	16V	B	GRM188B11C104KA01D	K22124805		1-	A	B3
C 2413	CHIP CAP.	0.1uF	16V	B	GRM188B11C104KA01D	K22124805		1-	A	A5
C 2414	CHIP CAP.	0.1uF	16V	B	GRM188B11C104KA01D	K22124805		1-	A	B5
C 2415	CHIP CAP.	0.1uF	16V	B	GRM188B11C104KA01D	K22124805		1-	A	B6
C 2416	CHIP CAP.	0.1uF	16V	B	GRM188B11C104KA01D	K22124805		1-	A	A4
C 2417	CHIP CAP.	820pF	50V	CH	GRM1882C1H821JA01D	K22174283		1-	A	A2
C 2418	CHIP CAP.	820pF	50V	CH	GRM1882C1H821JA01D	K22174283		1-	A	B3
C 2419	CHIP CAP.	820pF	50V	CH	GRM1882C1H821JA01D	K22174283		1-	A	B3
C 2420	CHIP CAP.	220pF	50V	CH	GRM1882C1H221JA01D	K22174243		1-	A	B4
C 2421	CHIP CAP.	150pF	50V	CH	GRM1882C1H151JA01D	K22174239		1-	A	B5
C 2422	CHIP CAP.	120pF	50V	CH	GRM1882C1H121JA01D	K22174237		1-	A	B6
C 2423	CHIP CAP.	82pF	50V	CH	GRM1882C1H820JA01D	K22174233		1-	A	B4
C 2425	CHIP CAP.	56pF	50V	CH	GRM1882C1H560JA01D	K22174229		1-	A	B3
C 2426	CHIP CAP.	120pF	50V	CH	GRM1882C1H121JA01D	K22174237		1-	A	B3
C 2427	CHIP CAP.	33pF	50V	CH	GRM1882C1H330JA01D	K22174223		1-	A	B4
C 2428	CHIP CAP.	22pF	50V	CH	GRM1882C1H220JA01D	K22174219		1-	A	B5
C 2429	CHIP CAP.	27pF	50V	CH	GRM1882C1H270JA01D	K22174221		1-	A	B6
C 2430	CHIP CAP.	6pF	50V	CH	GRM1882C1H6R0DZ01D	K22174207		1-	A	B4
C 2431	CHIP CAP.	0.0015uF	50V	CH	GRM1882C1H152JA01D	K22174277		1-	A	B1
C 2432	CHIP CAP.	680pF	50V	CH	GRM1882C1H681JA01D	K22174274		1-	A	B1
C 2434	CHIP CAP.	270pF	50V	CH	GRM1882C1H271JA01D	K22174251		1-	A	B2
C 2435	CHIP CAP.	6pF	50V	CH	GRM1882C1H6R0DZ01D	K22174207		1-	A	B2
C 2436	CHIP CAP.	82pF	50V	CH	GRM1882C1H820JA01D	K22174233		1-	A	B2
C 2437	CHIP CAP.	3pF	50V	CJ	GRM1883C1H3R0CZ01D	K22174204		1-	A	B3
C 2438	CHIP CAP.	39pF	50V	CH	GRM1882C1H390JA01D	K22174225		1-	A	B3
C 2439	CHIP CAP.	8pF	50V	CH	GRM1882C1H8R0DZ01D	K22174209		1-	A	B4
C 2440	CHIP CAP.	47pF	50V	CH	GRM1882C1H470JA01D	K22174227		1-	A	B4
C 2442	CHIP CAP.	47pF	50V	CH	GRM1882C1H470JA01D	K22174227		1-	A	B5
C 2444	CHIP CAP.	33pF	50V	CH	GRM1882C1H330JA01D	K22174223		1-	A	B6
C 2445	CHIP CAP.	2pF	50V	CK	GRM1884C1H2R0CZ01D	K22174203		1-	A	B4
C 2446	CHIP CAP.	12pF	50V	CH	GRM1882C1H120JA01D	K22174213		1-	A	B4
C 2447	CHIP CAP.	8pF	50V	CH	GRM1882C1H8R0DZ01D	K22174209		1-	A	B1
C 2448	CHIP CAP.	390pF	50V	CH	GRM1882C1H391JA01D	K22174255		1-	A	B1
C 2449	CHIP CAP.	0.0022uF	50V	CH	GRM1882C1H222JA01D	K22174279		1-	A	B2
C 2450	CHIP CAP.	0.0027uF	50V	CH	GRM1882C1H272JA01D	K22174280		1-	A	B1
C 2451	CHIP CAP.	0.0027uF	50V	CH	GRM1882C1H272JA01D	K22174280		1-	A	B3
C 2452	CHIP CAP.	0.0027uF	50V	CH	GRM1882C1H272JA01D	K22174280		1-	A	B3
C 2453	CHIP CAP.	680pF	50V	CH	GRM1882C1H681JA01D	K22174274		1-	A	B5
C 2454	CHIP CAP.	470pF	50V	CH	GRM1882C1H471JA01D	K22174249		1-	A	B5
C 2455	CHIP CAP.	470pF	50V	CH	GRM1882C1H471JA01D	K22174249		1-	A	B6
C 2456	CHIP CAP.	220pF	50V	CH	GRM1882C1H221JA01D	K22174243		1-	A	B4
C 2458	CHIP CAP.	0.0027uF	50V	CH	GRM1882C1H272JA01D	K22174280		1-	A	B1
C 2459	CHIP CAP.	330pF	50V	CH	GRM1882C1H331JA01D	K22174253		1-	A	B3
C 2460	CHIP CAP.	150pF	50V	CH	GRM1882C1H151JA01D	K22174239		1-	A	B3
C 2461	CHIP CAP.	82pF	50V	CH	GRM1882C1H820JA01D	K22174233		1-	A	B5
C 2462	CHIP CAP.	47pF	50V	CH	GRM1882C1H470JA01D	K22174227		1-	A	B5
C 2463	CHIP CAP.	18pF	50V	CH	GRM1882C1H180JA01D	K22174217		1-	A	B6
C 2464	CHIP CAP.	39pF	50V	CH	GRM1882C1H390JA01D	K22174225		1-	A	B4
C 2466	CHIP CAP.	0.0015uF	50V	CH	GRM1882C1H152JA01D	K22174277		1-	A	C1
C 2468	CHIP CAP.	270pF	50V	CH	GRM1882C1H271JA01D	K22174251		1-	A	B2
C 2469	CHIP CAP.	6pF	50V	CH	GRM1882C1H6R0DZ01D	K22174207		1-	A	C2
C 2470	CHIP CAP.	82pF	50V	CH	GRM1882C1H820JA01D	K22174233		1-	A	C2
C 2471	CHIP CAP.	3pF	50V	CJ	GRM1883C1H3R0CZ01D	K22174204		1-	A	C3
C 2472	CHIP CAP.	39pF	50V	CH	GRM1882C1H390JA01D	K22174225		1-	A	C3
C 2473	CHIP CAP.	8pF	50V	CH	GRM1882C1H8R0DZ01D	K22174209		1-	A	B4
C 2474	CHIP CAP.	47pF	50V	CH	GRM1882C1H470JA01D	K22174227		1-	A	B4
C 2476	CHIP CAP.	47pF	50V	CH	GRM1882C1H470JA01D	K22174227		1-	A	B5
C 2478	CHIP CAP.	33pF	50V	CH	GRM1882C1H330JA01D	K22174223		1-	A	B6
C 2479	CHIP CAP.	2pF	50V	CK	GRM1884C1H2R0CZ01D	K22174203		1-	A	B4
C 2480	CHIP CAP.	12pF	50V	CH	GRM1882C1H120JA01D	K22174213		1-	A	B4

BPF Unit

Parts List

REF	DESCRIPTION	VALUE	V/W	TOL.	MFR'S DESIG	VXSTD P/N	VERS.	LOT	SIDE	LAY ADR
C 2481	CHIP CAP.	270pF	50V	CH	GRM1882C1H271JA01D	K22174251		1-	A	C1
C 2482	CHIP CAP.	8pF	50V	CH	GRM1882C1H8R0DZ01D	K22174209		1-	A	C1
C 2483	CHIP CAP.	390pF	50V	CH	GRM1882C1H391JA01D	K22174255		1-	A	C1
C 2485	CHIP CAP.	56pF	50V	CH	GRM1882C1H560JA01D	K22174229		1-	A	C3
C 2486	CHIP CAP.	120pF	50V	CH	GRM1882C1H121JA01D	K22174237		1-	A	C3
C 2487	CHIP CAP.	33pF	50V	CH	GRM1882C1H330JA01D	K22174223		1-	A	C4
C 2488	CHIP CAP.	22pF	50V	CH	GRM1882C1H220JA01D	K22174219		1-	A	C5
C 2489	CHIP CAP.	27pF	50V	CH	GRM1882C1H270JA01D	K22174221		1-	A	C6
C 2490	CHIP CAP.	6pF	50V	CH	GRM1882C1H6R0DZ01D	K22174207		1-	A	C4
C 2491	CHIP CAP.	680pF	50V	CH	GRM1882C1H681JA01D	K22174274		1-	A	C1
C 2492	CHIP CAP.	820pF	50V	CH	GRM1882C1H821JA01D	K22174283		1-	A	C2
C 2493	CHIP CAP.	820pF	50V	CH	GRM1882C1H821JA01D	K22174283		1-	A	C3
C 2494	CHIP CAP.	820pF	50V	CH	GRM1882C1H821JA01D	K22174283		1-	A	C3
C 2495	CHIP CAP.	220pF	50V	CH	GRM1882C1H221JA01D	K22174243		1-	A	C4
C 2496	CHIP CAP.	150pF	50V	CH	GRM1882C1H151JA01D	K22174239		1-	A	C5
C 2497	CHIP CAP.	120pF	50V	CH	GRM1882C1H121JA01D	K22174237		1-	A	C6
C 2498	CHIP CAP.	82pF	50V	CH	GRM1882C1H820JA01D	K22174233		1-	A	C4
C 2499	CHIP CAP.	0.0015uF	50V	CH	GRM1882C1H152JA01D	K22174277		1-	A	C1
C 2500	CHIP CAP.	0.1uF	16V	B	GRM188B11C104KA01D	K22124805		1-	A	C1
C 2501	CHIP CAP.	0.1uF	16V	B	GRM188B11C104KA01D	K22124805		1-	A	C2
C 2502	CHIP CAP.	0.1uF	16V	B	GRM188B11C104KA01D	K22124805		1-	A	C3
C 2503	CHIP CAP.	0.1uF	16V	B	GRM188B11C104KA01D	K22124805		1-	A	C3
C 2504	CHIP CAP.	0.1uF	16V	B	GRM188B11C104KA01D	K22124805		1-	A	C5
C 2505	CHIP CAP.	0.1uF	16V	B	GRM188B11C104KA01D	K22124805		1-	A	C5
C 2506	CHIP CAP.	0.1uF	16V	B	GRM188B11C104KA01D	K22124805		1-	A	C6
C 2507	CHIP CAP.	0.1uF	16V	B	GRM188B11C104KA01D	K22124805		1-	A	C4
C 2508	CHIP CAP.	0.01uF	50V	B	GRM188B11H103KA01D	K22174823		1-	A	C1
C 2509	CHIP CAP.	0.01uF	50V	B	GRM188B11H103KA01D	K22174823		1-	A	C2
C 2510	CHIP CAP.	0.01uF	50V	B	GRM188B11H103KA01D	K22174823		1-	A	C3
C 2511	CHIP CAP.	0.01uF	50V	B	GRM188B11H103KA01D	K22174823		1-	A	C3
C 2512	CHIP CAP.	0.01uF	50V	B	GRM188B11H103KA01D	K22174823		1-	A	C5
C 2513	CHIP CAP.	0.01uF	50V	B	GRM188B11H103KA01D	K22174823		1-	A	C5
C 2514	CHIP CAP.	0.01uF	50V	B	GRM188B11H103KA01D	K22174823		1-	A	C6
C 2515	CHIP CAP.	0.01uF	50V	B	GRM188B11H103KA01D	K22174823		1-	A	C4
D 2401	DIODE				MA2J1110GL	G2071258		1-	A	A1
D 2402	DIODE				MA2J1110GL	G2071258		1-	A	A2
D 2403	DIODE				MA2J1110GL	G2071258		1-	A	B3
D 2404	DIODE				MA2J1110GL	G2071258		1-	A	B3
D 2405	DIODE				MA2J1110GL	G2071258		1-	A	A5
D 2406	DIODE				MA2J1110GL	G2071258		1-	A	A5
D 2407	DIODE				MA2J1110GL	G2071258		1-	A	A6
D 2408	DIODE				MA2J1110GL	G2071258		1-	A	A4
J 2401	CONNECTOR				IMSA-9133S-15D	P1091214		1-	A	A2
J 2402	CONNECTOR				IMSA-9133S-05D	P1090908		1-	A	D4
L 2401	M.RFC	1.8uH		5%	EL0606RA-1R8J-PF	L1790267		1-	A	A2
L 2402	M.RFC	0.56uH		10%	EL0606RA-R56K-PF	L1790261		1-	A	B2
L 2403	M.RFC	0.27uH		10%	EL0606RA-R27K-PF	L1790257		1-	A	B3
L 2404	M.RFC	0.39uH		10%	EL0606RA-R39K-PF	L1790259		1-	A	A5
L 2405	M.RFC	0.33uH		10%	EL0606RA-R33K-PF	L1790258		1-	A	A5
L 2406	M.RFC	0.22uH		10%	EL0606RA-R22K-PF	L1790256		1-	A	B6
L 2407	M.RFC	0.11uH		2%	C6342A-R11G-RA	L1691087		1-	A	B4
L 2408	M.RFC	3.3uH		5%	EL0606RA-3R3J-PF	L1790270		1-	A	A1
L 2409	M.RFC	5.6uH		5%	EL0606RA-5R6J-PF	L1790273		1-	A	B2
L 2410	M.RFC	5.6uH		5%	EL0606RA-5R6J-PF	L1790273		1-	A	B2
L 2411	M.RFC	5.6uH		5%	EL0606RA-5R6J-PF	L1790273		1-	A	B3
L 2412	M.RFC	1.8uH		5%	EL0606RA-1R8J-PF	L1790267		1-	A	B4
L 2413	M.RFC	1.2uH		5%	EL0606RA-1R2J-PF	L1790265		1-	A	B5
L 2414	M.RFC	1uH		5%	EL0606RA-1R0J-PF	L1790264		1-	A	B6
L 2415	CHIP COIL	0.68uH		2%	C2520C-R68G-RA	L1691305		1-	A	B4
L 2416	M.RFC	18uH		5%	EL0606RA-180J-PF	L1790279		1-	A	B1
L 2417	M.RFC	0.05uH		2%	C6342A-50NG-RA	L1691084		1-	A	C3
L 2418	M.RFC	0.68uH		10%	EL0606RA-R68K-PF	L1790262		1-	A	B2
L 2419	M.RFC	1uH		5%	EL0606RA-1R0J-PF	L1790264		1-	A	B1
L 2420	M.RFC	0.11uH		2%	C6342A-R11G-RA	L1691087		1-	A	C2
L 2421	M.RFC	0.088uH		2%	C6342A-88NG-RA	L1691086		1-	A	C3
L 2422	M.RFC	0.13uH		2%	C6342A-R13G-RA	L1691088		1-	A	B5
L 2423	M.RFC	0.11uH		2%	C6342A-R11G-RA	L1691087		1-	A	B5
L 2424	M.RFC	0.067uH		2%	C6342A-67NG-RA	L1691085		1-	A	B6
L 2425	M.RFC	0.035uH		2%	C6328A-35NG-RA-T25H	L1691082		1-	A	B4
L 2426	M.RFC	5.6uH		5%	EL0606RA-5R6J-PF	L1790273		1-	A	C2
L 2427	M.RFC	5.6uH		5%	EL0606RA-5R6J-PF	L1790273		1-	A	C2
L 2428	M.RFC	5.6uH		5%	EL0606RA-5R6J-PF	L1790273		1-	A	C3
L 2429	M.RFC	1.8uH		5%	EL0606RA-1R8J-PF	L1790267		1-	A	C4

BPF Unit

Parts List

REF	DESCRIPTION	VALUE	V/W	TOL.	MFR'S DESIG	VXSTD P/N	VERS.	LOT	SIDE	LAY ADR
L 2430	M.RFC	1.2uH		5%	EL0606RA-1R2J-PF	L1790265		1-	A	C5
L 2431	M.RFC	1uH		5%	EL0606RA-1R0J-PF	L1790264		1-	A	C6
L 2432	CHIP COIL	0.68uH		2%	C2520C-R68G-RA	L1691305		1-	A	C4
L 2433	M.RFC	18uH		5%	EL0606RA-180J-PF	L1790279		1-	A	C1
L 2434	M.RFC	1.8uH		5%	EL0606RA-1R8J-PF	L1790267		1-	A	C2
L 2435	M.RFC	0.56uH		10%	EL0606RA-R56K-PF	L1790261		1-	A	C2
L 2436	M.RFC	0.27uH		10%	EL0606RA-R27K-PF	L1790257		1-	A	C3
L 2437	M.RFC	0.39uH		10%	EL0606RA-R39K-PF	L1790259		1-	A	C5
L 2438	M.RFC	0.33uH		10%	EL0606RA-R33K-PF	L1790258		1-	A	C5
L 2439	M.RFC	0.22uH		10%	EL0606RA-R22K-PF	L1790256		1-	A	C6
L 2440	M.RFC	0.11uH		2%	C6342A-R11G-RA	L1691087		1-	A	C4
L 2441	M.RFC	3.3uH		5%	EL0606RA-3R3J-PF	L1790270		1-	A	C1
R 2401	CHIP RES.	100	1/16W	5%	RMC1/16 101JATP	J24185101		1-	A	A6
R 2402	CHIP RES.	100	1/16W	5%	RMC1/16 101JATP	J24185101		1-	A	A5
R 2403	CHIP RES.	100	1/16W	5%	RMC1/16 101JATP	J24185101		1-	A	A5
R 2404	CHIP RES.	100	1/16W	5%	RMC1/16 101JATP	J24185101		1-	A	A4
R 2405	CHIP RES.	100	1/16W	5%	RMC1/16 101JATP	J24185101		1-	A	A3
R 2406	CHIP RES.	100	1/16W	5%	RMC1/16 101JATP	J24185101		1-	A	B3
R 2407	CHIP RES.	100	1/16W	5%	RMC1/16 101JATP	J24185101		1-	A	A2
R 2408	CHIP RES.	100	1/16W	5%	RMC1/16 101JATP	J24185101		1-	A	A1
R 2410	CHIP RES.	0	1/16W	5%	RMC1/16 000JATP	J24185000		1-	A	A1
RL2401	RELAY		DC12V		FTR-B3GA012Z-B10 DC12V	M1190201		1-	A	A1
RL2402	RELAY		DC12V		FTR-B3GA012Z-B10 DC12V	M1190201		1-	A	A2
RL2403	RELAY		DC12V		FTR-B3GA012Z-B10 DC12V	M1190201		1-	A	A2
RL2404	RELAY		DC12V		FTR-B3GA012Z-B10 DC12V	M1190201		1-	A	A3
RL2405	RELAY		DC12V		FTR-B3GA012Z-B10 DC12V	M1190201		1-	A	A4
RL2406	RELAY		DC12V		FTR-B3GA012Z-B10 DC12V	M1190201		1-	A	A5
RL2407	RELAY		DC12V		FTR-B3GA012Z-B10 DC12V	M1190201		1-	A	A5
RL2408	RELAY		DC12V		FTR-B3GA012Z-B10 DC12V	M1190201		1-	A	A4
RL2409	RELAY		DC12V		FTR-B3GA012Z-B10 DC12V	M1190201		1-	A	D2
RL2410	RELAY		DC12V		FTR-B3GA012Z-B10 DC12V	M1190201		1-	A	D2
RL2411	RELAY		DC12V		FTR-B3GA012Z-B10 DC12V	M1190201		1-	A	D3
RL2412	RELAY		DC12V		FTR-B3GA012Z-B10 DC12V	M1190201		1-	A	D4
RL2413	RELAY		DC12V		FTR-B3GA012Z-B10 DC12V	M1190201		1-	A	D5
RL2414	RELAY		DC12V		FTR-B3GA012Z-B10 DC12V	M1190201		1-	A	D5
RL2415	RELAY		DC12V		FTR-B3GA012Z-B10 DC12V	M1190201		1-	A	C4
RL2416	RELAY		DC12V		FTR-B3GA012Z-B10 DC12V	M1190201		1-	A	D1
	SHIELD CASE COVER				(115x70)	RA1151700		1-		

BPF Unit

Note:

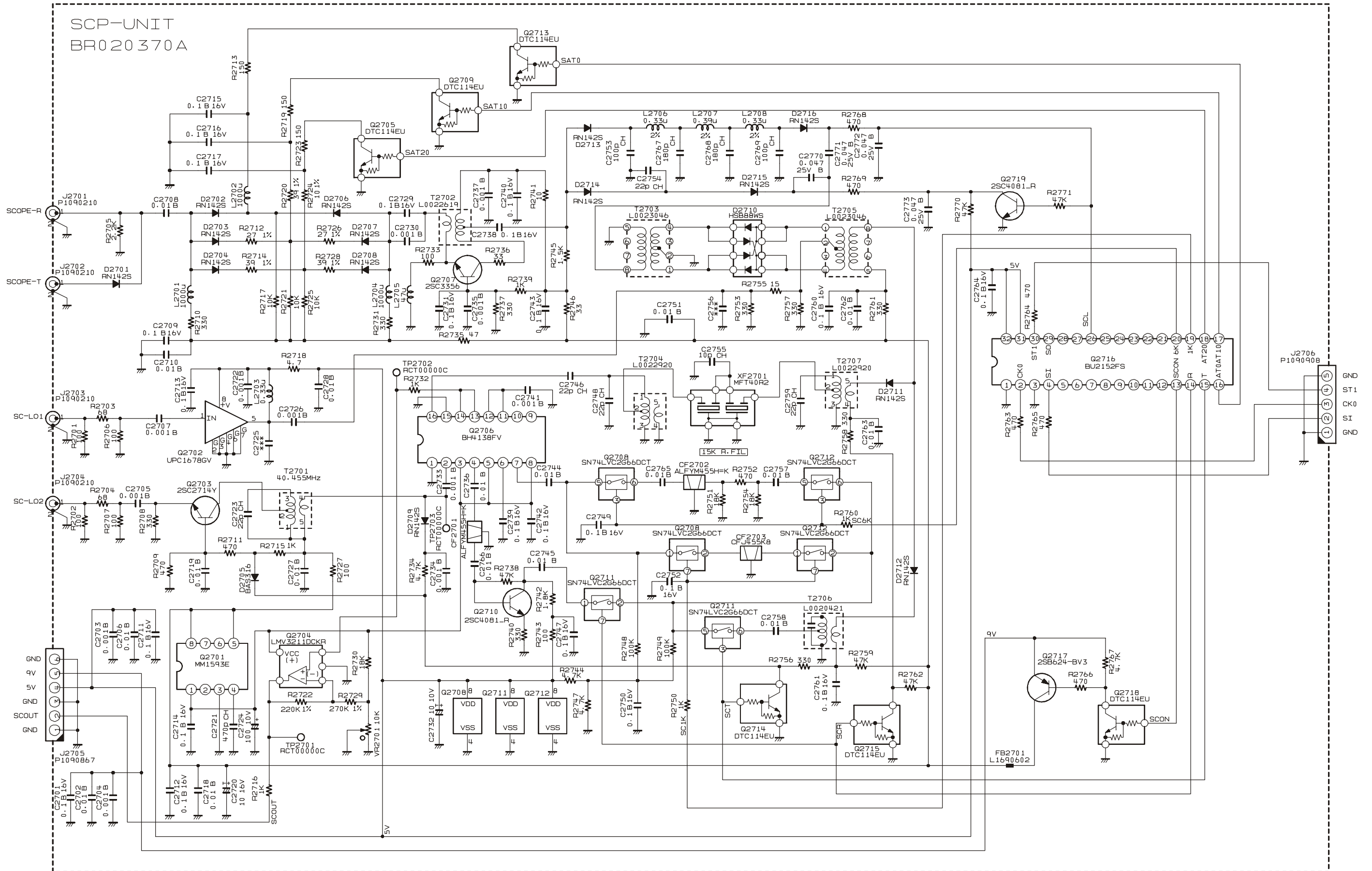

SCP Unit

Parts Layout

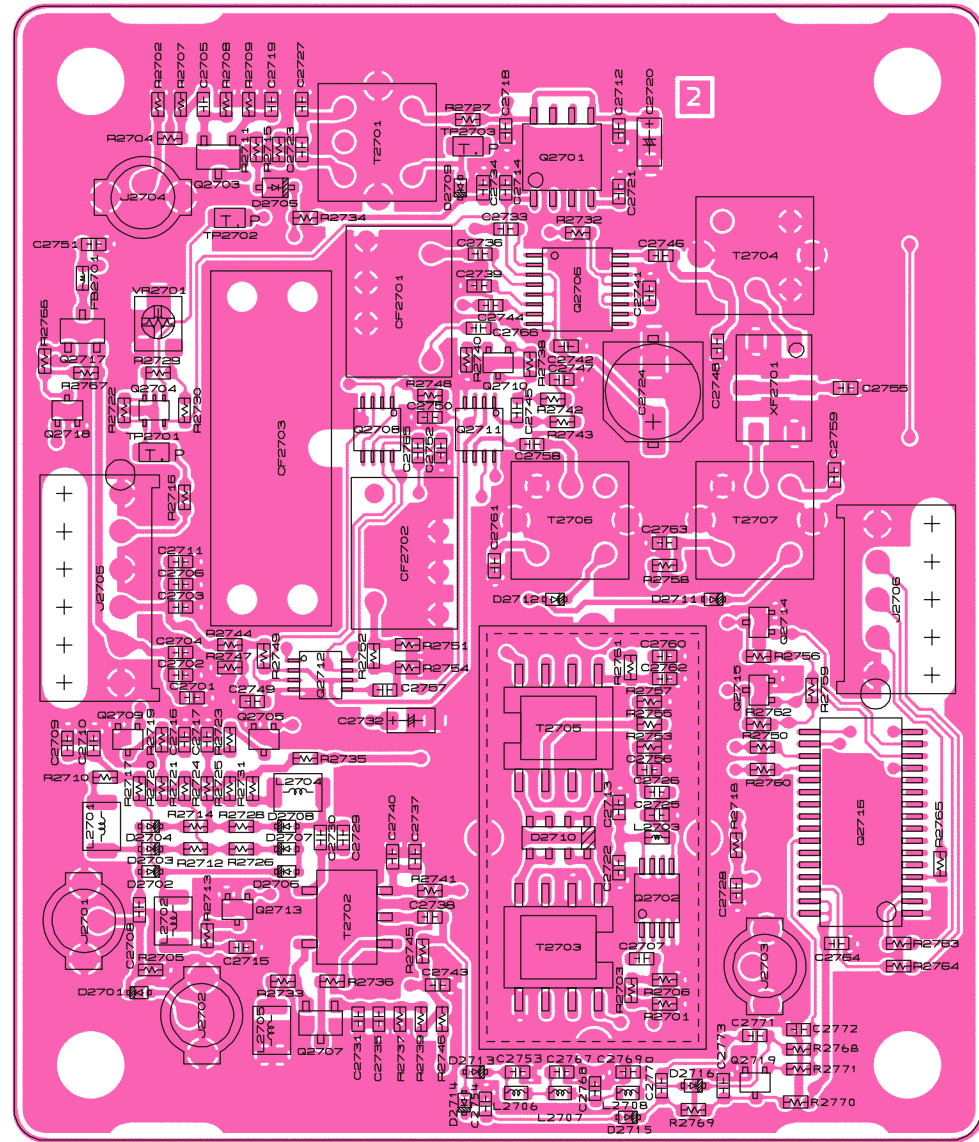

(Side A)

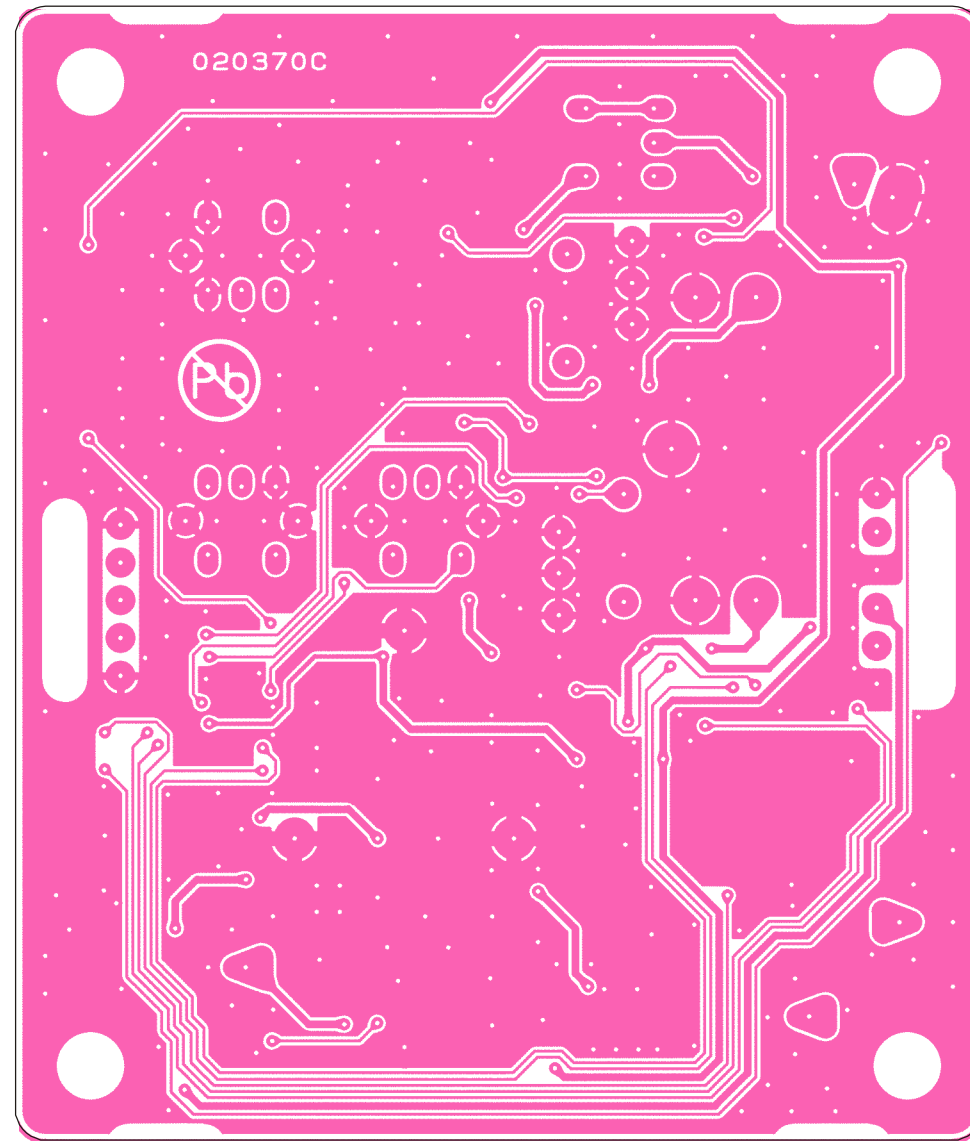

(Side B)

REF	DESCRIPTION	VALUE	V/W	TOL.	MFR'S DESIG	VXSTD P/N	VERS.	LOT	SIDE	LAY ADR
PCB with Components						CB4934001				
	Printed Circuit Board					FR020370C				
C 2701	CHIP CAP.	0.1uF	16V	B	GRM188B11C104KA01D	K22124805		1-	A	A3
C 2702	CHIP CAP.	0.01uF	50V	B	GRM188B11H103KA01D	K22174823		1-	A	A3
C 2703	CHIP CAP.	0.001uF	50V	B	GRM188B11H102KA01D	K22174821		1-	A	A2
C 2704	CHIP CAP.	0.001uF	50V	B	GRM188B11H102KA01D	K22174821		1-	A	A3
C 2705	CHIP CAP.	0.001uF	50V	B	GRM188B11H102KA01D	K22174821		1-	A	A1
C 2706	CHIP CAP.	0.01uF	50V	B	GRM188B11H103KA01D	K22174823		1-	A	A2
C 2707	CHIP CAP.	0.001uF	50V	B	GRM188B11H102KA01D	K22174821		1-	A	C4
C 2708	CHIP CAP.	0.01uF	50V	B	GRM188B11H103KA01D	K22174823		1-	A	A3
C 2709	CHIP CAP.	0.1uF	16V	B	GRM188B11C104KA01D	K22124805		1-	A	A3
C 2710	CHIP CAP.	0.01uF	50V	B	GRM188B11H103KA01D	K22174823		1-	A	A3
C 2711	CHIP CAP.	0.1uF	16V	B	GRM188B11C104KA01D	K22124805		1-	A	A2
C 2712	CHIP CAP.	0.1uF	16V	B	GRM188B11C104KA01D	K22124805		1-	A	C1
C 2713	CHIP CAP.	0.1uF	16V	B	GRM188B11C104KA01D	K22124805		1-	A	C3
C 2714	CHIP CAP.	0.1uF	16V	B	GRM188B11C104KA01D	K22124805		1-	A	B1
C 2715	CHIP CAP.	0.1uF	16V	B	GRM188B11C104KA01D	K22124805		1-	A	A4
C 2716	CHIP CAP.	0.1uF	16V	B	GRM188B11C104KA01D	K22124805		1-	A	A3
C 2717	CHIP CAP.	0.1uF	16V	B	GRM188B11C104KA01D	K22124805		1-	A	A3
C 2718	CHIP CAP.	0.01uF	50V	B	GRM188B11H103KA01D	K22174823		1-	A	B1
C 2719	CHIP CAP.	0.01uF	50V	B	GRM188B11H103KA01D	K22174823		1-	A	A1
C 2720	CHIP TA.CAP.	10uF	16V		TEESVA1C106M8R	K78120077		1-	A	C1
C 2721	CHIP CAP.	470pF	50V	CH	GRM1882C1H471JA01D	K22174249		1-	A	C1
C 2722	CHIP CAP.	0.001uF	50V	B	GRM188B11H102KA01D	K22174821		1-	A	C3
C 2723	CHIP CAP.	22pF	50V	CH	GRM1882C1H220JA01D	K22174219		1-	A	A1
C 2724	AL.ELECTRO.CAP.	100uF	10V		RVZ-10V101MF55U-R2	K48100008		1-	A	C2
C 2726	CHIP CAP.	0.001uF	50V	B	GRM188B11H102KA01D	K22174821		1-	A	C3
C 2727	CHIP CAP.	0.01uF	50V	B	GRM188B11H103KA01D	K22174823		1-	A	A1
C 2728	CHIP CAP.	0.01uF	50V	B	GRM188B11H103KA01D	K22174823		1-	A	C3
C 2729	CHIP CAP.	0.1uF	16V	B	GRM188B11C104KA01D	K22124805		1-	A	B3
C 2730	CHIP CAP.	0.001uF	50V	B	GRM188B11H102KA01D	K22174821		1-	A	B3
C 2731	CHIP CAP.	0.1uF	16V	B	GRM188B11C104KA01D	K22124805		1-	A	B4
C 2732	CHIP TA.CAP.	10uF	10V		TEESVA1A106M8R	K78100028		1-	A	B3
C 2733	CHIP CAP.	0.001uF	50V	B	GRM188B11H102KA01D	K22174821		1-	A	B1
C 2734	CHIP CAP.	0.001uF	50V	B	GRM188B11H102KA01D	K22174821		1-	A	B1
C 2735	CHIP CAP.	0.001uF	50V	B	GRM188B11H102KA01D	K22174821		1-	A	B4
C 2736	CHIP CAP.	0.01uF	50V	B	GRM188B11H103KA01D	K22174823		1-	A	B1
C 2737	CHIP CAP.	0.001uF	50V	B	GRM188B11H102KA01D	K22174821		1-	A	B3
C 2738	CHIP CAP.	0.1uF	16V	B	GRM188B11C104KA01D	K22124805		1-	A	B4
C 2739	CHIP CAP.	0.1uF	16V	B	GRM188B11C104KA01D	K22124805		1-	A	B1
C 2740	CHIP CAP.	0.1uF	16V	B	GRM188B11C104KA01D	K22124805		1-	A	B3
C 2741	CHIP CAP.	0.001uF	50V	B	GRM188B11H102KA01D	K22174821		1-	A	C1
C 2742	CHIP CAP.	0.1uF	16V	B	GRM188B11C104KA01D	K22124805		1-	A	B2
C 2743	CHIP CAP.	0.1uF	16V	B	GRM188B11C104KA01D	K22124805		1-	A	B4
C 2744	CHIP CAP.	0.01uF	50V	B	GRM188B11H103KA01D	K22174823		1-	A	B1
C 2745	CHIP CAP.	0.01uF	50V	B	GRM188B11H103KA01D	K22174823		1-	A	B2
C 2746	CHIP CAP.	22pF	50V	CH	GRM1882C1H220JA01D	K22174219		1-	A	C1
C 2747	CHIP CAP.	0.1uF	16V	B	GRM188B11C104KA01D	K22124805		1-	A	B2
C 2748	CHIP CAP.	22pF	50V	CH	GRM1882C1H220JA01D	K22174219		1-	A	C2
C 2749	CHIP CAP.	0.1uF	16V	B	GRM188B11C104KA01D	K22124805		1-	A	A3
C 2750	CHIP CAP.	0.1uF	16V	B	GRM188B11C104KA01D	K22124805		1-	A	A2
C 2751	CHIP CAP.	0.01uF	50V	B	GRM188B11H103KA01D	K22174823		1-	A	B1
C 2752	CHIP CAP.	0.1uF	16V	B	GRM188B11C104KA01D	K22124805		1-	A	B2
C 2753	CHIP CAP.	100pF	50V	CH	GRM1882C1H101JA01D	K22174235		1-	A	B4
C 2754	CHIP CAP.	22pF	50V	CH	GRM1882C1H220JA01D	K22174219		1-	A	B4
C 2755	CHIP CAP.	10pF	50V	CH	GRM1882C1H100JA01D	K22174211		1-	A	C2
C 2757	CHIP CAP.	0.01uF	50V	B	GRM188B11H103KA01D	K22174823		1-	A	B3
C 2758	CHIP CAP.	0.01uF	50V	B	GRM188B11H103KA01D	K22174823		1-	A	B2
C 2759	CHIP CAP.	22pF	50V	CH	GRM1882C1H220JA01D	K22174219		1-	A	C2
C 2760	CHIP CAP.	0.1uF	16V	B	GRM188B11C104KA01D	K22124805		1-	A	C3
C 2761	CHIP CAP.	0.1uF	16V	B	GRM188B11C104KA01D	K22124805		1-	A	B2
C 2762	CHIP CAP.	0.01uF	50V	B	GRM188B11H103KA01D	K22174823		1-	A	C3
C 2763	CHIP CAP.	0.01uF	50V	B	GRM188B11H103KA01D	K22174823		1-	A	C2
C 2764	CHIP CAP.	0.1uF	16V	B	GRM188B11C104KA01D	K22124805		1-	A	C4
C 2765	CHIP CAP.	0.01uF	50V	B	GRM188B11H103KA01D	K22174823		1-	A	B2
C 2766	CHIP CAP.	0.01uF	50V	B	GRM188B11H103KA01D	K22174823		1-	A	B2
C 2767	CHIP CAP.	180pF	50V	CH	GRM1882C1H181JA01D	K22174241		1-	A	B4
C 2768	CHIP CAP.	180pF	50V	CH	GRM1882C1H181JA01D	K22174241		1-	A	B4
C 2769	CHIP CAP.	100pF	50V	CH	GRM1882C1H101JA01D	K22174235		1-	A	C4
C 2770	CHIP CAP.	0.047uF	25V	B	GRM188B11E473KA01D	K22144811		1-	A	C4
C 2771	CHIP CAP.	0.047uF	25V	B	GRM188B11E473KA01D	K22144811		1-	A	C4
C 2772	CHIP CAP.	0.047uF	25V	B	GRM188B11E473KA01D	K22144811		1-	A	C4
C 2773	CHIP CAP.	0.047uF	25V	B	GRM188B11E473KA01D	K22144811		1-	A	C4

SCP Unit

Parts List

REF	DESCRIPTION	VALUE	V/W	TOL.	MFR'S DESIG	VXSTD P/N	VERS.	LOT	SIDE	LAY ADR
CF2701	CERAMIC FILTER				ALFYM455H=K	H3900542		1-	A	B2
CF2702	CERAMIC FILTER				ALFYM455H=K	H3900542		1-	A	B2
CF2703	CERAMIC FILTER				CFJ455K8	H3900553		1-	A	A1
D 2701	DIODE				RN142S TE61	G2070994		1-	A	A4
D 2702	DIODE				RN142S TE61	G2070994		1-	A	A3
D 2703	DIODE				RN142S TE61	G2070994		1-	A	A3
D 2704	DIODE				RN142S TE61	G2070994		1-	A	A3
D 2705	DIODE				BAS316	G2070716		1-	A	A1
D 2706	DIODE				RN142S TE61	G2070994		1-	A	A3
D 2707	DIODE				RN142S TE61	G2070994		1-	A	A3
D 2708	DIODE				RN142S TE61	G2070994		1-	A	A3
D 2709	DIODE				RN142S TE61	G2070994		1-	A	B1
D 2710	DIODE				HSB88WS TR-E	G2070290		1-	A	B3
D 2711	DIODE				RN142S TE61	G2070994		1-	A	C2
D 2712	DIODE				RN142S TE61	G2070994		1-	A	B2
D 2713	DIODE				RN142S TE61	G2070994		1-	A	B4
D 2714	DIODE				RN142S TE61	G2070994		1-	A	B4
D 2715	DIODE				RN142S TE61	G2070994		1-	A	C4
D 2716	DIODE				RN142S TE61	G2070994		1-	A	C4
FB2701	FERRITE BEADS				BLM18BD182SN1D	L1690602		1-	A	A1
J 2701	CONNECTOR				TMP-J01X-V6	P1090210		1-	A	A4
J 2702	CONNECTOR				TMP-J01X-V6	P1090210		1-	A	A4
J 2703	CONNECTOR				TMP-J01X-V6	P1090210		1-	A	C4
J 2704	CONNECTOR				TMP-J01X-V6	P1090210		1-	A	A1
J 2705	CONNECTOR				IMSA-9133S-06D	P1090867		1-	A	A2
J 2706	CONNECTOR				IMSA-9133S-05D	P1090908		1-	A	C3
L 2701	M.RFC	1000uH			LLM3225-102J	L1691157		1-	A	A3
L 2702	M.RFC	1000uH			LLM3225-102J	L1691157		1-	A	A4
L 2703	M.RFC	0.33uH			LK1608 R33K-T	L1690412		1-	A	C3
L 2704	M.RFC	1000uH			LLM3225-102J	L1691157		1-	A	A3
L 2705	M.RFC	47uH			LLM3225-470J	L1691141		1-	A	A4
L 2706	M.RFC	0.33uH		2%	C1608CB-R33G-RF	L1691106		1-	A	B4
L 2707	M.RFC	0.39uH		2%	C1608CB-R39G-RF	L1691107		1-	A	B4
L 2708	M.RFC	0.33uH		2%	C1608CB-R33G-RF	L1691106		1-	A	C4
Q 2701	IC				MM1593EFBEG	G1094300		1-	A	B1
Q 2702	IC				UPC1678GV-E1	G1094126		1-	A	C3
Q 2703	TRANSISTOR				2SC2714Y(TE85R.F)	G3327147Y		1-	A	A1
Q 2704	IC				LMV321IDCKR	G1093969		1-	A	A2
Q 2705	TRANSISTOR				DTC114EUA T106	G3070084		1-	A	A3
Q 2706	IC				BH4138FV-E2	G1093713		1-	A	B1
Q 2707	TRANSISTOR				2SC3356-T2B R24	G3333567D		1-	A	B4
Q 2708	IC				SN74LVC2G66DCTR	G1094049		1-	A	B2
Q 2709	TRANSISTOR				DTC114EUA T106	G3070084		1-	A	A3
Q 2710	TRANSISTOR				2SC4081 T106 R	G3340818R		1-	A	B2
Q 2711	IC				SN74LVC2G66DCTR	G1094049		1-	A	B2
Q 2712	IC				SN74LVC2G66DCTR	G1094049		1-	A	B3
Q 2713	TRANSISTOR				DTC114EUA T106	G3070084		1-	A	A3
Q 2714	TRANSISTOR				DTC114EUA T106	G3070084		1-	A	C3
Q 2715	TRANSISTOR				DTC114EUA T106	G3070084		1-	A	C3
Q 2716	IC				BU2152FS(TAPE)	G1093942		1-	A	C3
Q 2717	TRANSISTOR				2SB624-T2B BV3	G3206247C		1-	A	A2
Q 2718	TRANSISTOR				DTC114EUA T106	G3070084		1-	A	A2
Q 2719	TRANSISTOR				2SC4081 T106 R	G3340818R		1-	A	C4
R 2701	CHIP RES.	100	1/16W	5%	RMC1/16 101JATP	J24185101		1-	A	C4
R 2702	CHIP RES.	100	1/16W	5%	RMC1/16 101JATP	J24185101		1-	A	A1
R 2703	CHIP RES.	68	1/16W	5%	RMC1/16 680JATP	J24185680		1-	A	C4
R 2704	CHIP RES.	68	1/16W	5%	RMC1/16 680JATP	J24185680		1-	A	A1
R 2705	CHIP RES.	2.2k	1/16W	5%	RMC1/16 222JATP	J24185222		1-	A	A4
R 2706	CHIP RES.	100	1/16W	5%	RMC1/16 101JATP	J24185101		1-	A	C4
R 2707	CHIP RES.	100	1/16W	5%	RMC1/16 101JATP	J24185101		1-	A	A1
R 2708	CHIP RES.	330	1/16W	5%	RMC1/16 331JATP	J24185331		1-	A	A1
R 2709	CHIP RES.	470	1/16W	5%	RMC1/16 471JATP	J24185471		1-	A	A1
R 2710	CHIP RES.	330	1/16W	5%	RMC1/16 331JATP	J24185331		1-	A	A3
R 2711	CHIP RES.	470	1/16W	5%	RMC1/16 471JATP	J24185471		1-	A	A1
R 2712	CHIP RES.	27	1/16W	5%	RMC1/16 270JATP	J24185270		1	A	A3
R 2712	CHIP RES.	27	1/16W	1%	RMC1/16 270FTP	J24183270		2-	A	A3
R 2713	CHIP RES.	150	1/16W	5%	RMC1/16 151JATP	J24185151		1-	A	A4
R 2714	CHIP RES.	39	1/16W	5%	RMC1/16 390JATP	J24185390		1	A	A3
R 2714	CHIP RES.	39	1/16W	1%	RMC1/16 390FTP	J24183390		2-	A	A3
R 2715	CHIP RES.	1k	1/16W	5%	RMC1/16 102JATP	J24185102		1-	A	A1
R 2716	CHIP RES.	1k	1/16W	5%	RMC1/16 102JATP	J24185102		1-	A	A2
R 2717	CHIP RES.	10k	1/16W	5%	RMC1/16 103JATP	J24185103		1-	A	A3
R 2718	CHIP RES.	4.7	1/16W	5%	RMC1/16 4R7JATP	J24185479		1-	A	C3

SCP Unit

Parts List

REF	DESCRIPTION	VALUE	V/W	TOL.	MFR'S DESIG	VXSTD P/N	VERS.	LOT	SIDE	LAY ADR
R 2719	CHIP RES.	150	1/16W	5%	RMC1/16 151JATP	J24185151		1-	A	A3
R 2720	CHIP RES.	39	1/16W	5%	RMC1/16 390JATP	J24185390		1	A	A3
R 2720	CHIP RES.	39	1/16W	1%	RMC1/16 390FTP	J24183390		2-	A	A3
R 2721	CHIP RES.	10k	1/16W	5%	RMC1/16 103JATP	J24185103		1-	A	A3
R 2722	CHIP RES.	220k	1/16W	1%	RMC1/16 224FTP	J24183224		1-	A	A2
R 2723	CHIP RES.	150	1/16W	5%	RMC1/16 151JATP	J24185151		1-	A	A3
R 2724	CHIP RES.	10	1/16W	5%	RMC1/16 100JATP	J24185100		1	A	A3
R 2724	CHIP RES.	10	1/16W	1%	RMC1/16 100FTP	J24183100		2-	A	A3
R 2725	CHIP RES.	10k	1/16W	5%	RMC1/16 103JATP	J24185103		1-	A	A3
R 2726	CHIP RES.	27	1/16W	5%	RMC1/16 270JATP	J24185270		1	A	A3
R 2726	CHIP RES.	27	1/16W	1%	RMC1/16 270FTP	J24183270		2-	A	A3
R 2727	CHIP RES.	100	1/16W	5%	RMC1/16 101JATP	J24185101		1-	A	B1
R 2728	CHIP RES.	39	1/16W	5%	RMC1/16 390JATP	J24185390		1	A	A3
R 2728	CHIP RES.	39	1/16W	1%	RMC1/16 390FTP	J24183390		2-	A	A3
R 2729	CHIP RES.	270k	1/16W	1%	RMC1/16 274FTP	J24183274		1-	A	A2
R 2730	CHIP RES.	27k	1/16W	5%	RMC1/16 273JATP	J24185273		1	A	A2
R 2730	CHIP RES.	18k	1/16W	5%	RMC1/16 183JATP	J24185183		2-	A	A2
R 2731	CHIP RES.	330	1/16W	5%	RMC1/16 331JATP	J24185331		1-	A	A3
R 2732	CHIP RES.	1k	1/16W	5%	RMC1/16 102JATP	J24185102		1-	A	B1
R 2733	CHIP RES.	100	1/16W	5%	RMC1/16 101JATP	J24185101		1-	A	A4
R 2734	CHIP RES.	4.7k	1/16W	5%	RMC1/16 472JATP	J24185472		1-	A	A1
R 2735	CHIP RES.	47	1/16W	5%	RMC1/16 470JATP	J24185470		1-	A	A3
R 2736	CHIP RES.	33	1/16W	5%	RMC1/16 330JATP	J24185330		1-	A	B4
R 2737	CHIP RES.	330	1/16W	5%	RMC1/16 331JATP	J24185331		1-	A	B4
R 2738	CHIP RES.	47k	1/16W	5%	RMC1/16 473JATP	J24185473		1-	A	B2
R 2739	CHIP RES.	1k	1/16W	5%	RMC1/16 102JATP	J24185102		1-	A	B4
R 2740	CHIP RES.	330	1/16W	5%	RMC1/16 331JATP	J24185331		1-	A	B2
R 2741	CHIP RES.	10	1/16W	5%	RMC1/16 100JATP	J24185100		1-	A	B3
R 2742	CHIP RES.	1.8k	1/16W	5%	RMC1/16 182JATP	J24185182		1-	A	B2
R 2743	CHIP RES.	100	1/16W	5%	RMC1/16 101JATP	J24185101		1-	A	B2
R 2744	CHIP RES.	4.7k	1/16W	5%	RMC1/16 472JATP	J24185472		1-	A	A3
R 2745	CHIP RES.	1.5k	1/16W	5%	RMC1/16 152JATP	J24185152		1-	A	B4
R 2746	CHIP RES.	33	1/16W	5%	RMC1/16 330JATP	J24185330		1-	A	B4
R 2747	CHIP RES.	4.7k	1/16W	5%	RMC1/16 472JATP	J24185472		1-	A	A3
R 2748	CHIP RES.	100k	1/16W	5%	RMC1/16 104JATP	J24185104		1-	A	B2
R 2749	CHIP RES.	100k	1/16W	5%	RMC1/16 104JATP	J24185104		1-	A	A3
R 2750	CHIP RES.	1k	1/16W	5%	RMC1/16 102JATP	J24185102		1-	A	C3
R 2751	CHIP RES.	18k	1/16W	5%	RMC1/16 183JATP	J24185183		1-	A	B3
R 2752	CHIP RES.	470	1/16W	5%	RMC1/16 471JATP	J24185471		1-	A	B3
R 2753	CHIP RES.	330	1/16W	5%	RMC1/16 331JATP	J24185331		1-	A	C3
R 2754	CHIP RES.	18k	1/16W	5%	RMC1/16 183JATP	J24185183		1-	A	B3
R 2755	CHIP RES.	15	1/16W	5%	RMC1/16 150JATP	J24185150		1-	A	C3
R 2756	CHIP RES.	330	1/16W	5%	RMC1/16 331JATP	J24185331		1-	A	C3
R 2757	CHIP RES.	330	1/16W	5%	RMC1/16 331JATP	J24185331		1-	A	C3
R 2758	CHIP RES.	330	1/16W	5%	RMC1/16 331JATP	J24185331		1-	A	C2
R 2759	CHIP RES.	47k	1/16W	5%	RMC1/16 473JATP	J24185473		1-	A	C3
R 2760	CHIP RES.	1k	1/16W	5%	RMC1/16 102JATP	J24185102		1-	A	C3
R 2761	CHIP RES.	330	1/16W	5%	RMC1/16 331JATP	J24185331		1-	A	C3
R 2762	CHIP RES.	47k	1/16W	5%	RMC1/16 473JATP	J24185473		1-	A	C3
R 2763	CHIP RES.	470	1/16W	5%	RMC1/16 471JATP	J24185471		1-	A	C4
R 2764	CHIP RES.	470	1/16W	5%	RMC1/16 471JATP	J24185471		1-	A	C4
R 2765	CHIP RES.	470	1/16W	5%	RMC1/16 471JATP	J24185471		1-	A	D3
R 2766	CHIP RES.	470	1/16W	5%	RMC1/16 471JATP	J24185471		1-	A	A2
R 2767	CHIP RES.	4.7k	1/16W	5%	RMC1/16 472JATP	J24185472		1-	A	A2
R 2768	CHIP RES.	470	1/16W	5%	RMC1/16 471JATP	J24185471		1-	A	C4
R 2769	CHIP RES.	470	1/16W	5%	RMC1/16 471JATP	J24185471		1-	A	C4
R 2770	CHIP RES.	47k	1/16W	5%	RMC1/16 473JATP	J24185473		1-	A	C4
R 2771	CHIP RES.	47k	1/16W	5%	RMC1/16 473JATP	J24185473		1-	A	C4
T 2701	COIL 07RF	40.455MHz			M7-T1 R-12W083A	L0022920		1-	A	B1
T 2702	COIL WIDE-TRANS.				3-318707	L0022619		1-	A	B4
T 2703	BALUN TRANSFORMERS				070812735D	L0023046		1-	A	B4
T 2704	COIL 07RF	40.455MHz			M7-T1 R-12W083A	L0022920		1-	A	C1
T 2705	BALUN TRANSFORMERS				070812735D	L0023046		1-	A	B3
T 2706	COIL RF				R12°7935A	L0020421		1-	A	B2
T 2707	COIL 07RF	40.455MHz			M7-T1 R-12W083A	L0022920		1-	A	C2
TP2701	CHECK TERMINAL				RCT00000C	Q5000103		1-	A	A2
TP2702	CHECK TERMINAL				RCT00000C	Q5000103		1-	A	A1
TP2703	CHECK TERMINAL				RCT00000C	Q5000103		1-	A	B1
VR2701	POT.	10k			EVN-5ESX50B14	J51811103		1-	A	A2
XF2701	XTAL FILTER				MFT40R2 40.455MHz 15kHz	H1102386		1-	A	C2
	SHIELD CASE				(28x15)	RA1152200		1-		
	SHIELD CASE COVER				(28x15)	RA1152300		1-		
	SHIELD CASE COVER				(75X64)	RA1151900		1-		

SCP Unit

Note:

DVS Unit

Circuit Diagram

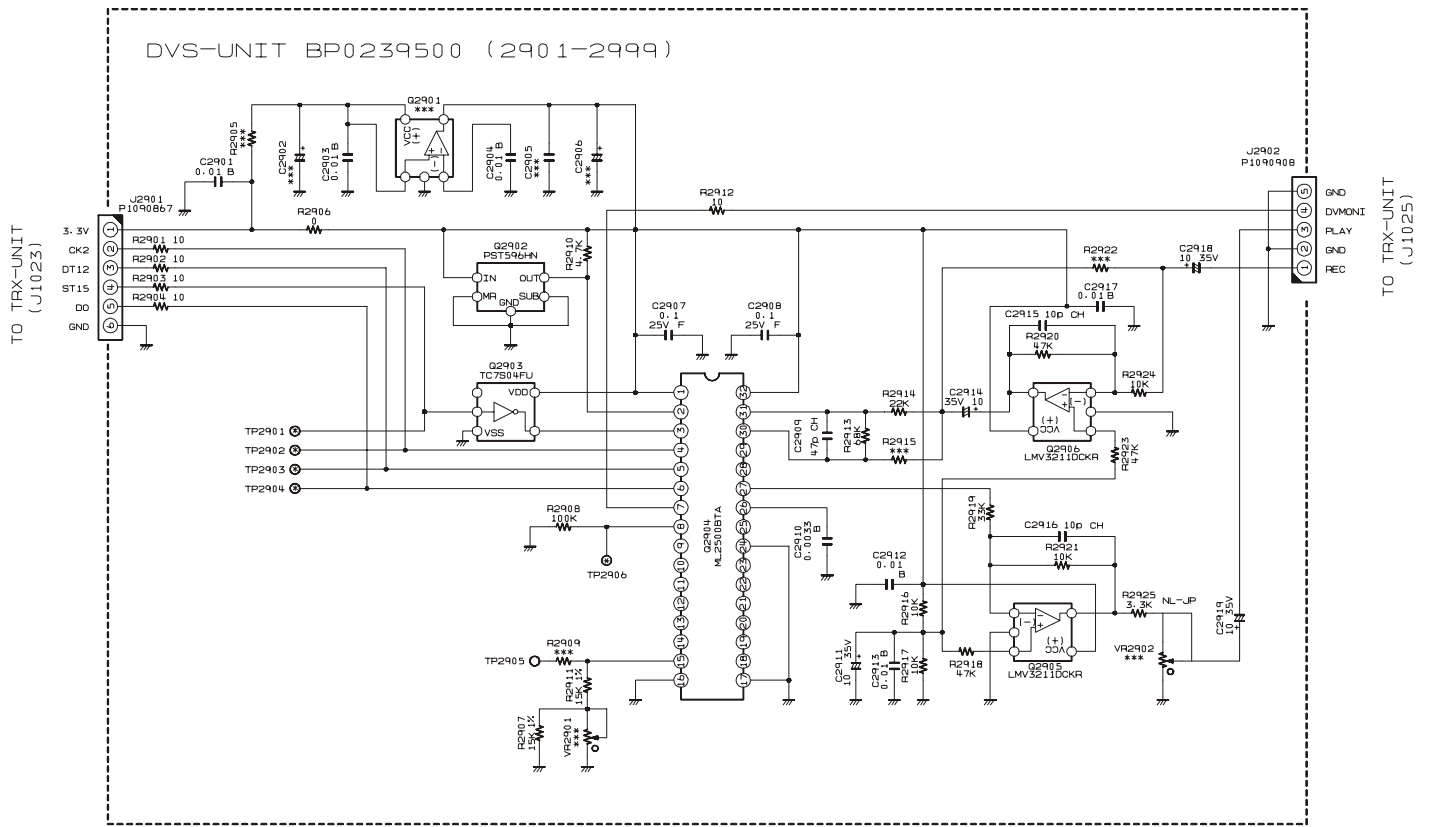

Parts Layout

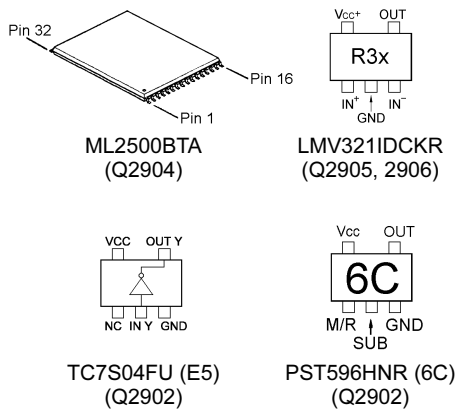

Side A

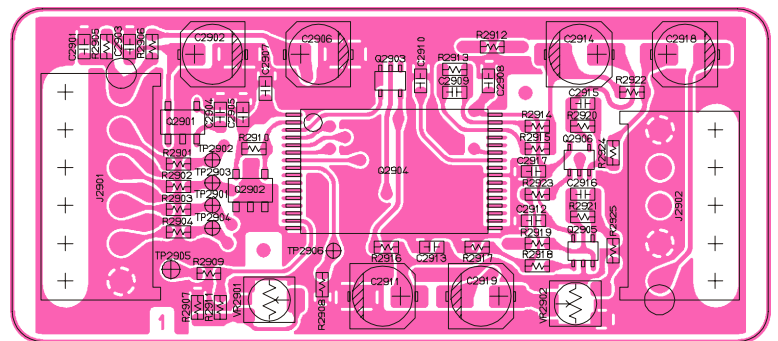

Side B

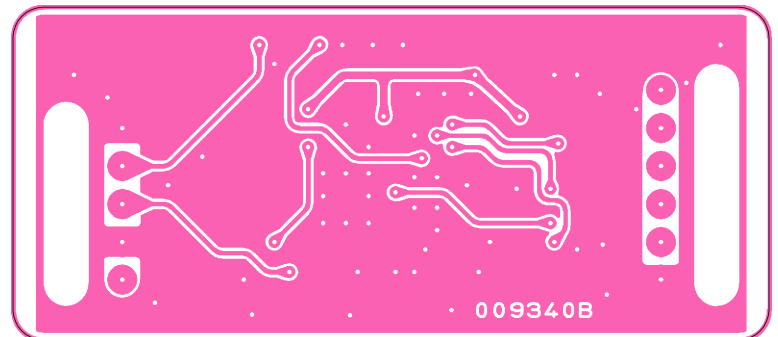

DVS Unit

Parts List

REF	DESCRIPTION	VALUE	V/W	TOL.	MFR'S DESIG	VXSTD P/N	VERS.	LOT	SIDE	LAY ADR
PCB with Components						CS2073501				
	Printed Circuit Board					FR009340B		1-		
C 2901	CHIP CAP.	0.01uF	50V	B	GRM188B11H103KA01D	K22174823		1-	A	A1
C 2903	CHIP CAP.	0.01uF	50V	B	GRM188B11H103KA01D	K22174823		1-	A	A1
C 2904	CHIP CAP.	0.01uF	50V	B	GRM188B11H103KA01D	K22174823		1-	A	A1
C 2907	CHIP CAP.	0.1uF	25V	F	GRM188F11E104ZA01D	K22145001		1-	A	A1
C 2908	CHIP CAP.	0.1uF	25V	F	GRM188F11E104ZA01D	K22145001		1-	A	B1
C 2909	CHIP CAP.	47pF	50V	CH	GRM1882C1H470JA01D	K22174227		1-	A	B1
C 2910	CHIP CAP.	0.0033uF	50V	B	GRM188B11H332KA01D	K22174831		1-	A	B1
C 2911	AL.ELECTRO.CAP.	10uF	35V		EEE1VA100WR	K48160006		1-	A	B1
C 2912	CHIP CAP.	0.01uF	50V	B	GRM188B11H103KA01D	K22174823		1-	A	B1
C 2913	CHIP CAP.	0.01uF	50V	B	GRM188B11H103KA01D	K22174823		1-	A	B1
C 2914	AL.ELECTRO.CAP.	10uF	35V		EEE1VA100WR	K48160006		1-	A	B1
C 2915	CHIP CAP.	10pF	50V	CH	GRM1882C1H100JA01D	K22174211		1-	A	B1
C 2916	CHIP CAP.	10pF	50V	CH	GRM1882C1H100JA01D	K22174211		1-	A	B1
C 2917	CHIP CAP.	0.01uF	50V	B	GRM188B11H103KA01D	K22174823		1-	A	B1
C 2918	AL.ELECTRO.CAP.	10uF	35V		EEE1VA100WR	K48160006		1-	A	C1
C 2919	AL.ELECTRO.CAP.	10uF	35V		EEE1VA100WR	K48160006		1-	A	B1
J 2901	CONNECTOR				IMSA-9133S-06D	P1090867		1-	A	A1
J 2902	CONNECTOR				IMSA-9133S-05D	P1090908		1-	A	C1
Q 2902	IC				PST596HNR	G1092574		1-	A	A1
Q 2903	IC				TC7S04FU(TE85R.F)	G1091530		1-	A	B1
Q 2904	IC				ML2500BTAZ03A	G1093715		1-	A	B1
Q 2905	IC				LMV321DCKR	G1093969		1-	A	B1
Q 2906	IC				LMV321DCKR	G1093969		1-	A	B1
R 2901	CHIP RES.	10	1/16W	5%	RMC1/16 100JATP	J24185100		1-	A	A1
R 2902	CHIP RES.	10	1/16W	5%	RMC1/16 100JATP	J24185100		1-	A	A1
R 2903	CHIP RES.	10	1/16W	5%	RMC1/16 100JATP	J24185100		1-	A	A1
R 2904	CHIP RES.	10	1/16W	5%	RMC1/16 100JATP	J24185100		1-	A	A1
R 2906	CHIP RES.	0	1/16W	5%	RMC1/16 000JATP	J24185000		1-	A	A1
R 2907	CHIP RES.	15k	1/16W	1%	RMC1/16 153FTP	J24183153		1-	A	A1
R 2908	CHIP RES.	100k	1/16W	5%	RMC1/16 104JATP	J24185104		1-	A	B1
R 2910	CHIP RES.	4.7k	1/16W	5%	RMC1/16 472JATP	J24185472		1-	A	A1
R 2911	CHIP RES.	15k	1/16W	1%	RMC1/16 153FTP	J24183153		1-	A	A1
R 2912	CHIP RES.	10	1/16W	5%	RMC1/16 100JATP	J24185100		1-	A	B1
R 2913	CHIP RES.	68k	1/16W	5%	RMC1/16 683JATP	J24185683		1-	A	B1
R 2914	CHIP RES.	22k	1/16W	5%	RMC1/16 223JATP	J24185223		1-	A	B1
R 2916	CHIP RES.	10k	1/16W	5%	RMC1/16 103JATP	J24185103		1-	A	B1
R 2917	CHIP RES.	10k	1/16W	5%	RMC1/16 103JATP	J24185103		1-	A	B1
R 2918	CHIP RES.	47k	1/16W	5%	RMC1/16 473JATP	J24185473		1-	A	B1
R 2919	CHIP RES.	33k	1/16W	5%	RMC1/16 333JATP	J24185333		1-	A	B1
R 2920	CHIP RES.	47k	1/16W	5%	RMC1/16 473JATP	J24185473		1-	A	B1
R 2921	CHIP RES.	10k	1/16W	5%	RMC1/16 103JATP	J24185103		1-	A	B1
R 2923	CHIP RES.	47k	1/16W	5%	RMC1/16 473JATP	J24185473		1-	A	B1
R 2924	CHIP RES.	10k	1/16W	5%	RMC1/16 103JATP	J24185103		1-	A	B1
R 2925	CHIP RES.	3.3k	1/16W	5%	RMC1/16 332JATP	J24185332		1-	A	B1

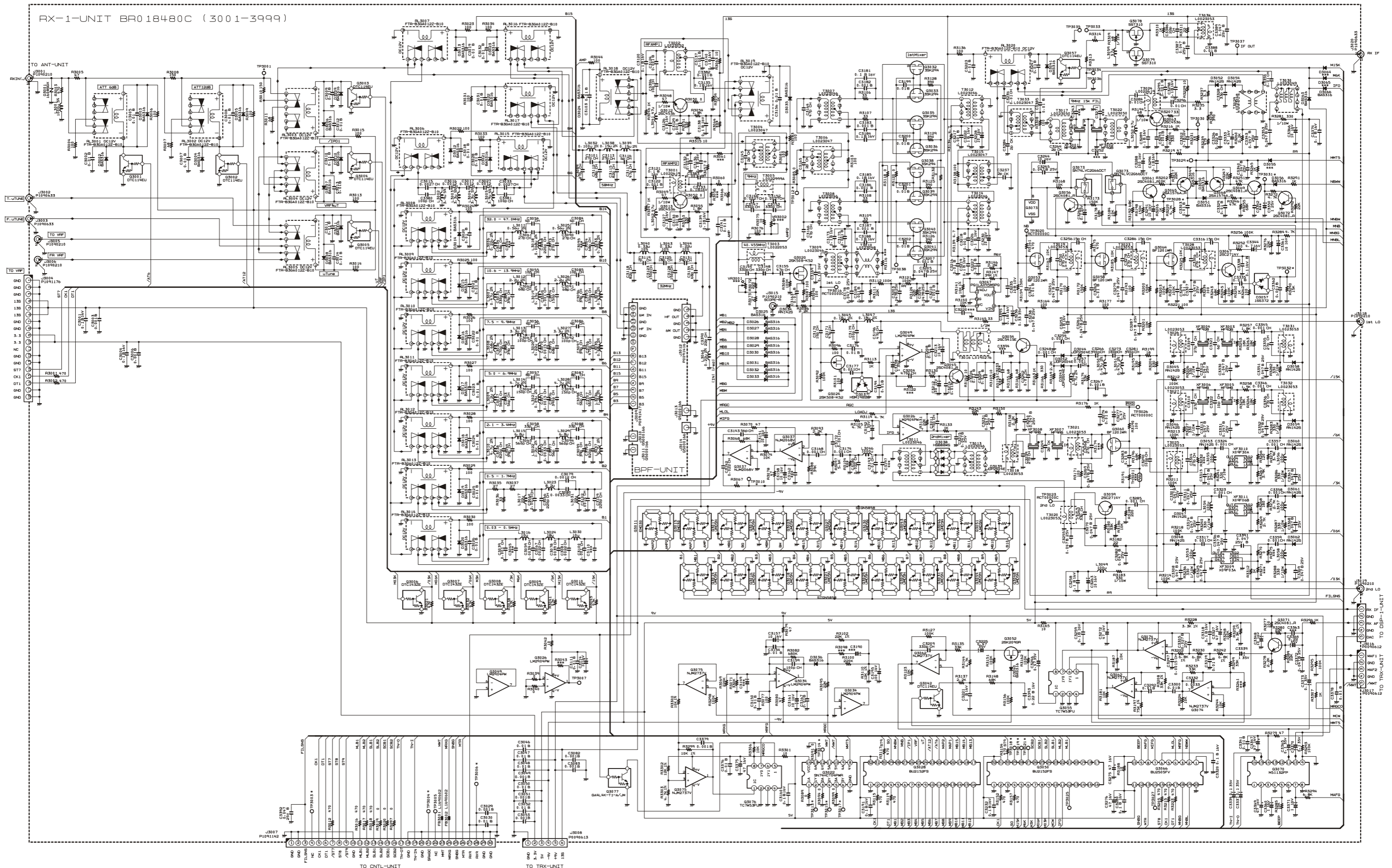

RX-1 Unit (Lot. 1 ~ 3)

Note

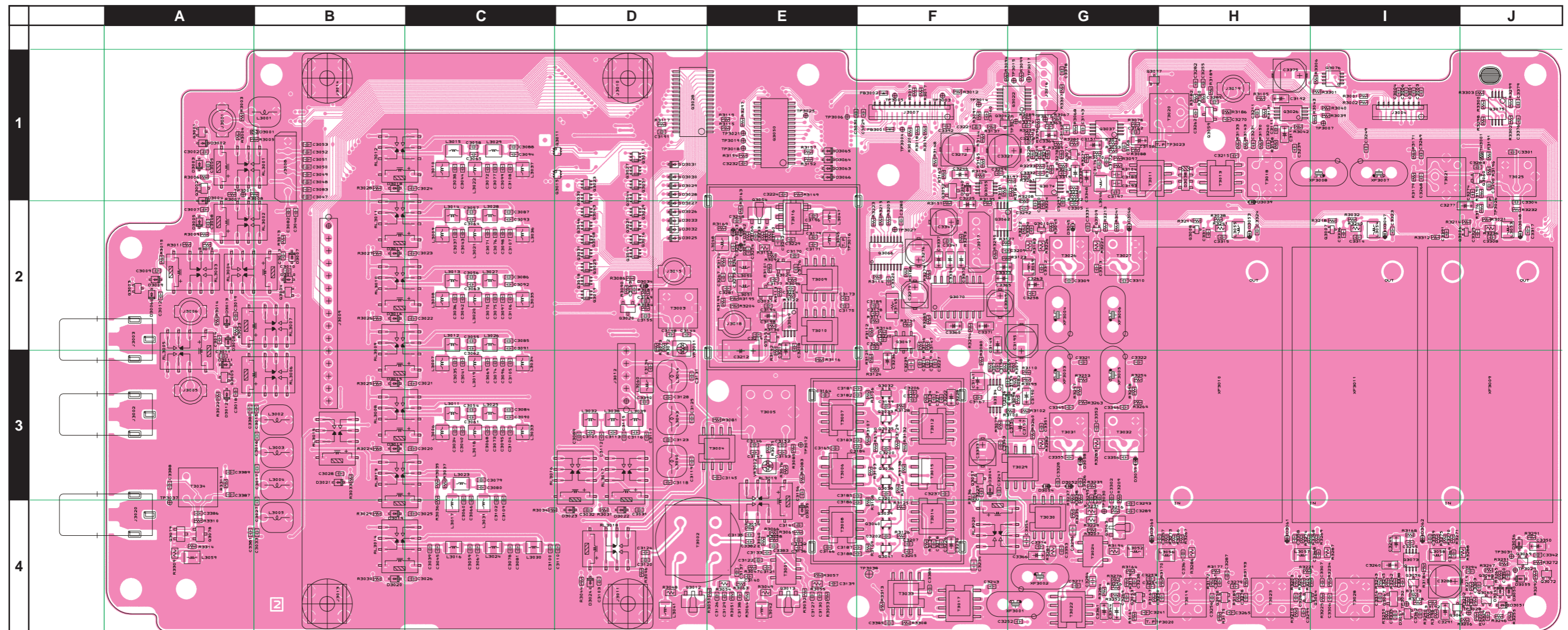

RX-1 Unit (Lot. 1 ~ 3)

Parts Layout (Side B)

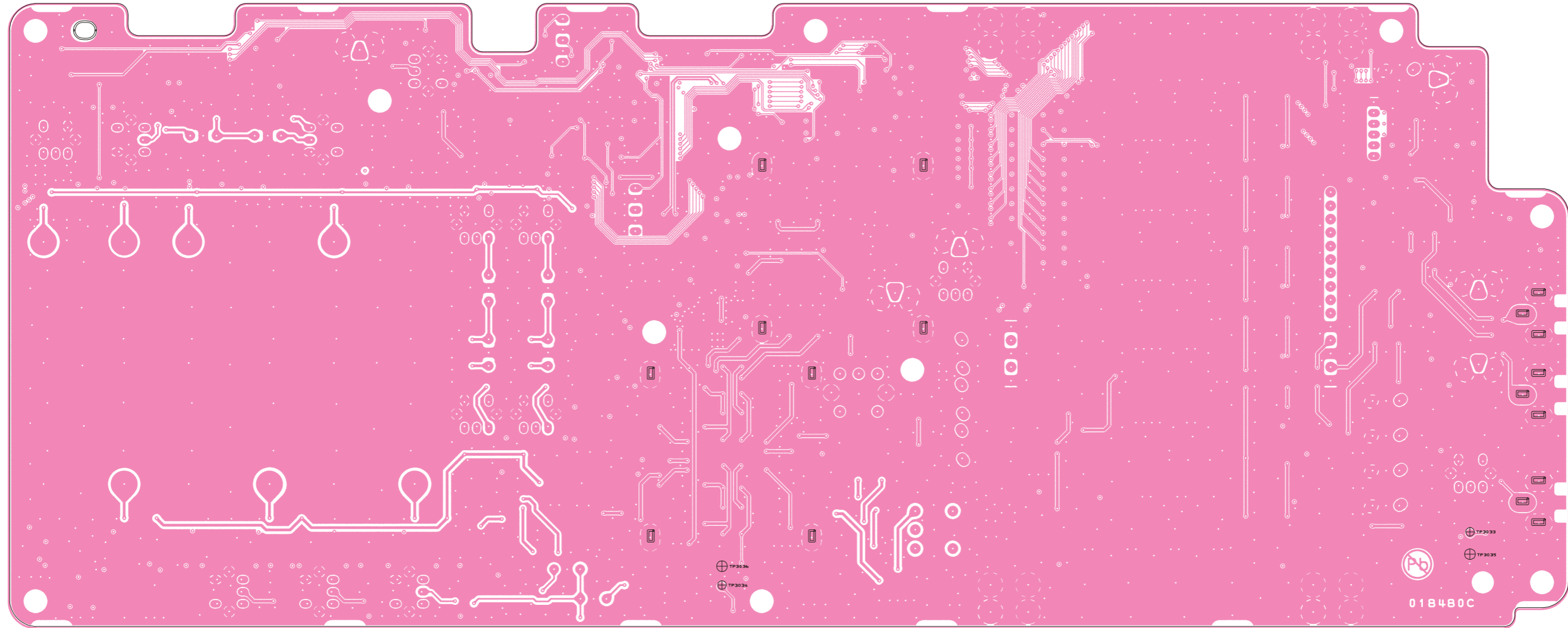

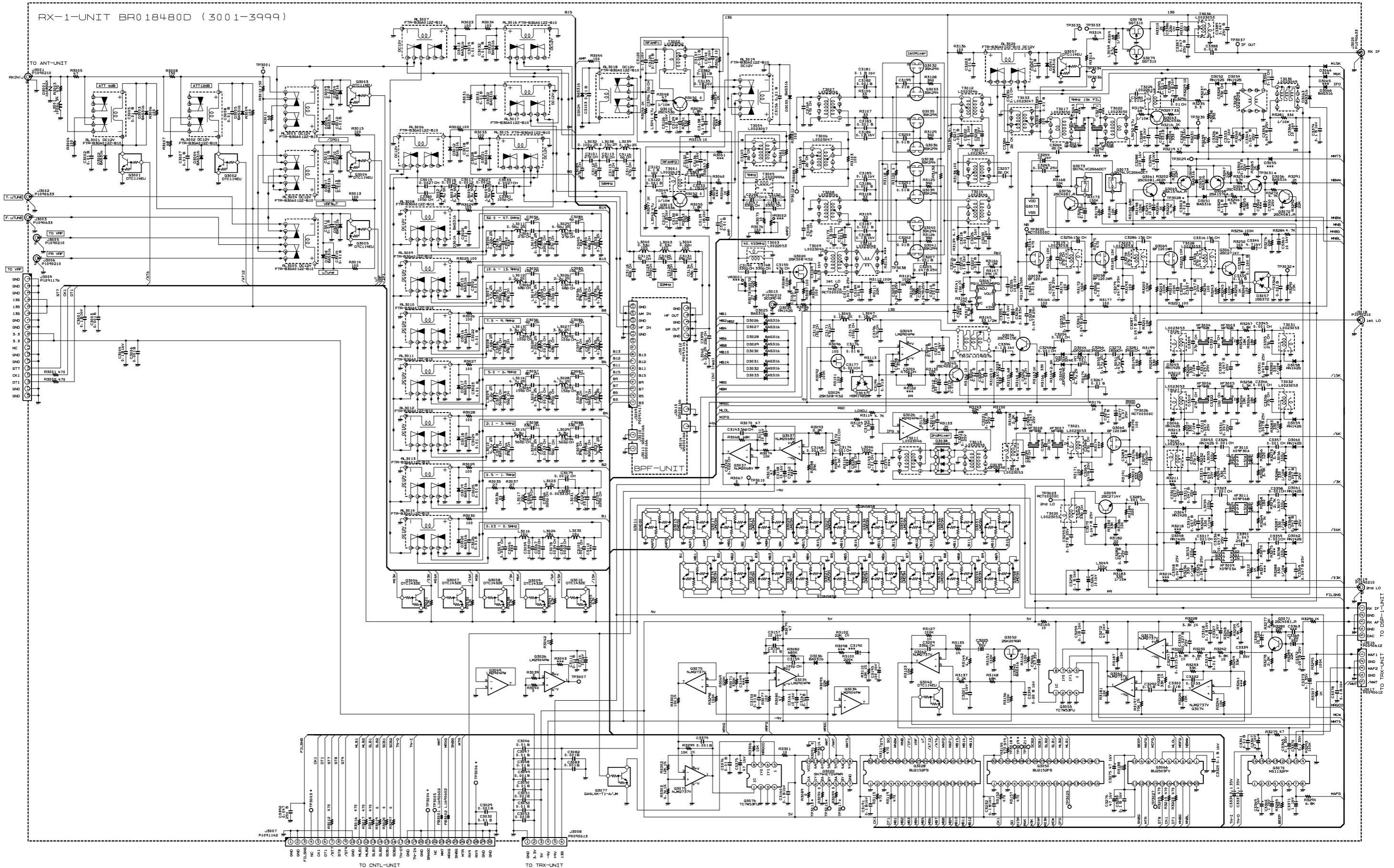

RX-1 Unit (Lot. 4 ~ 7)

Note

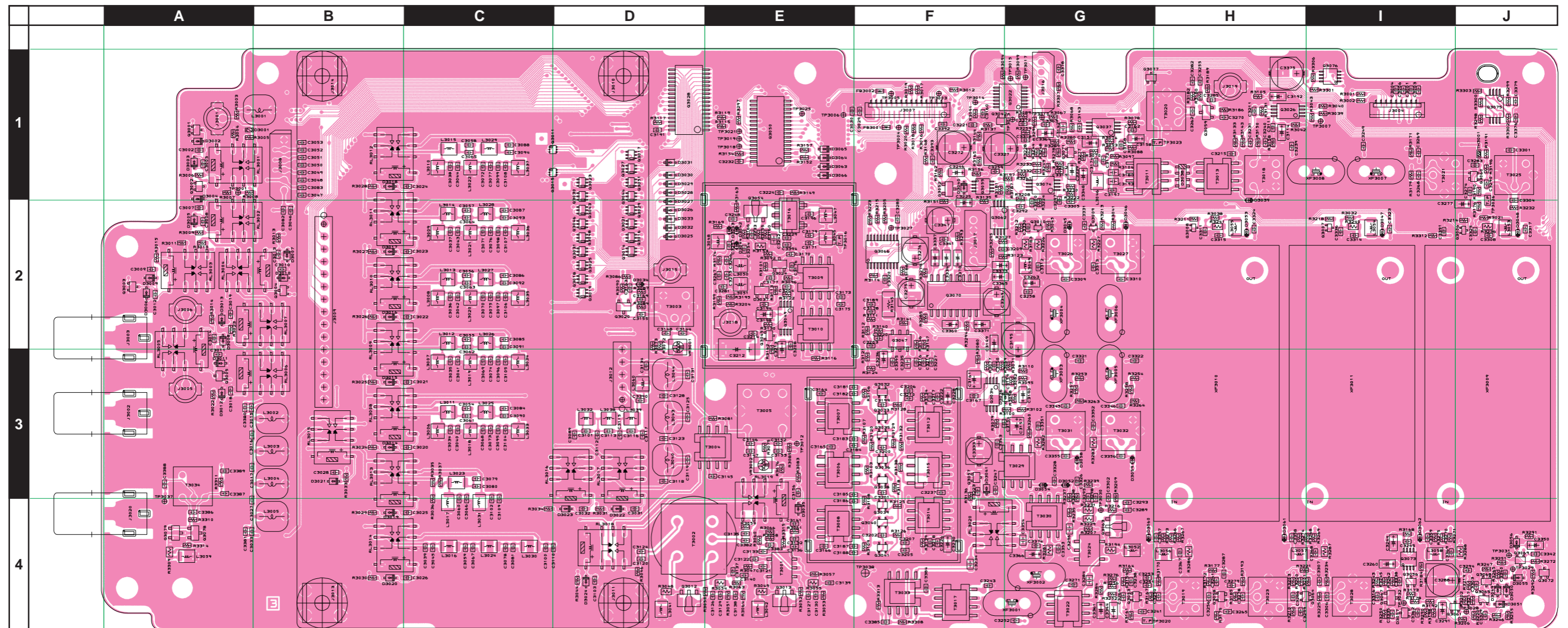

RX-1 Unit (Lot. 4 ~ 7)

Parts Layout (Side B)

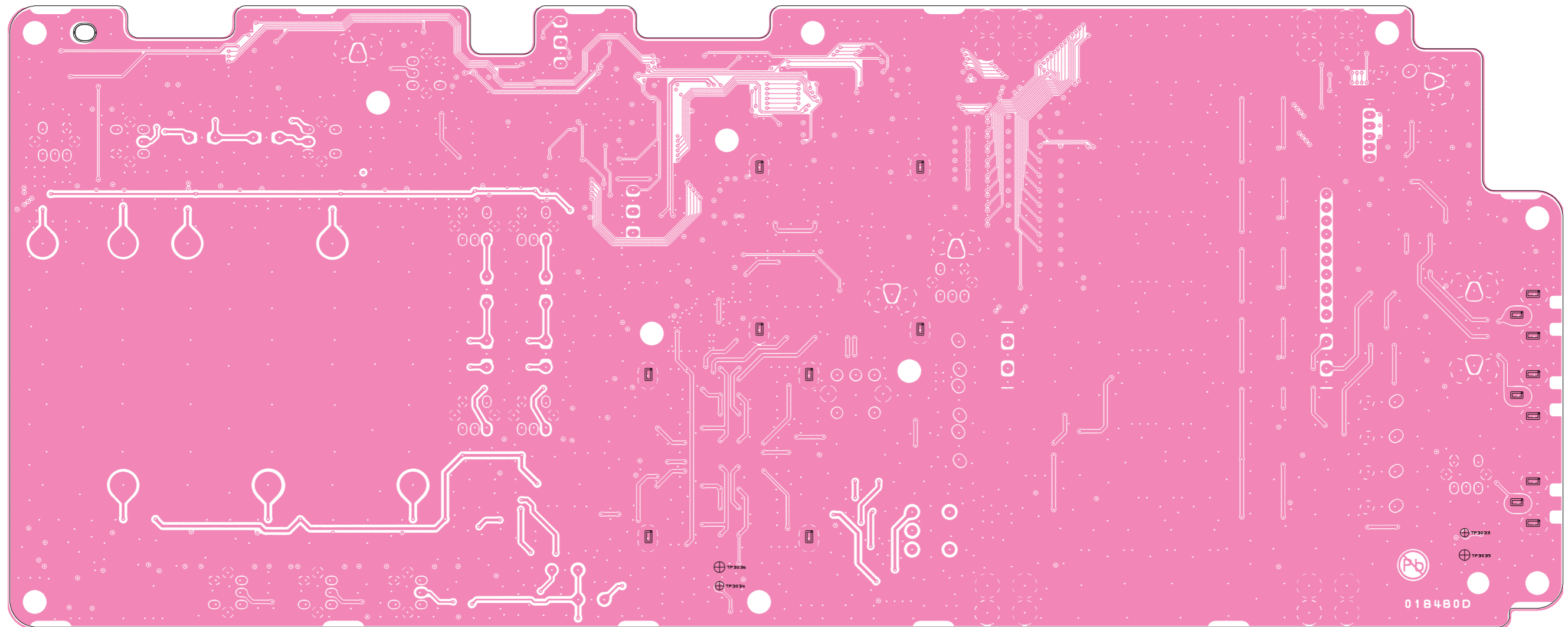

RX-1 Unit (Lot. 8 ~)

Note

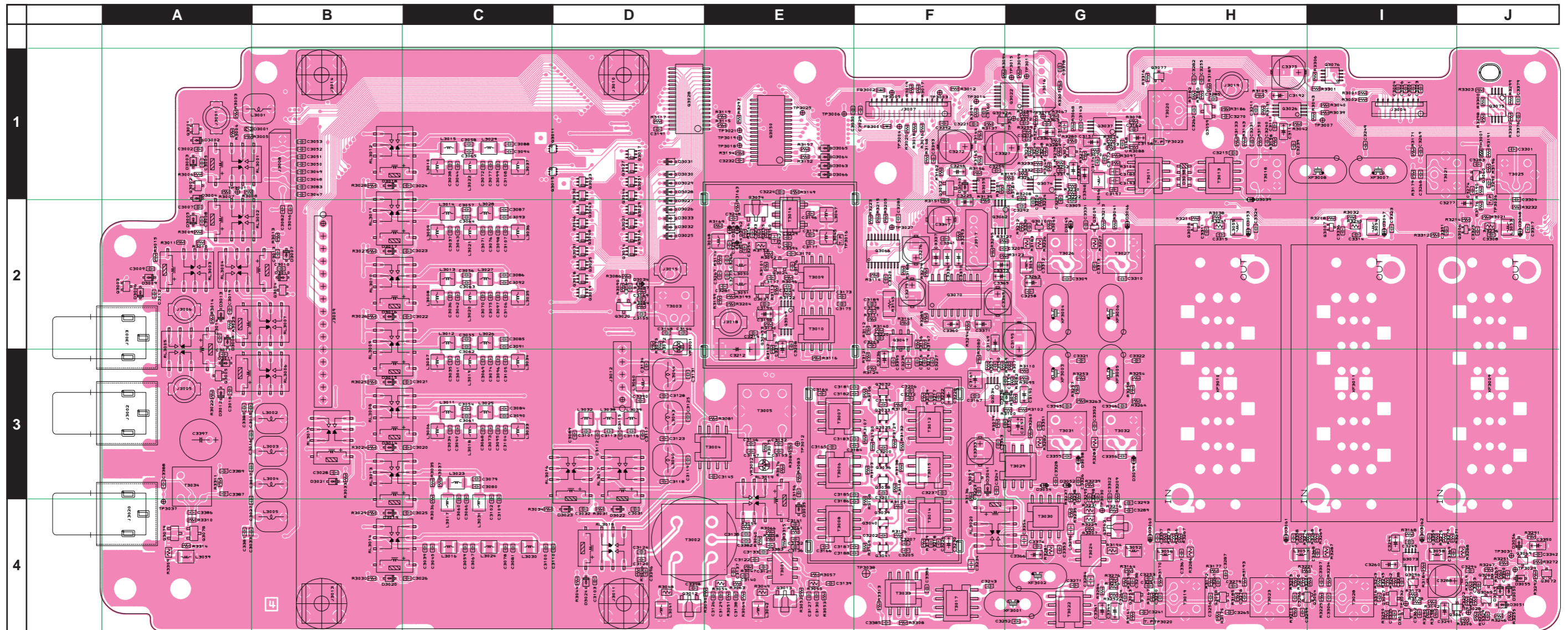

RX-1 Unit (Lot. 8 ~)

Parts Layout (Side B)

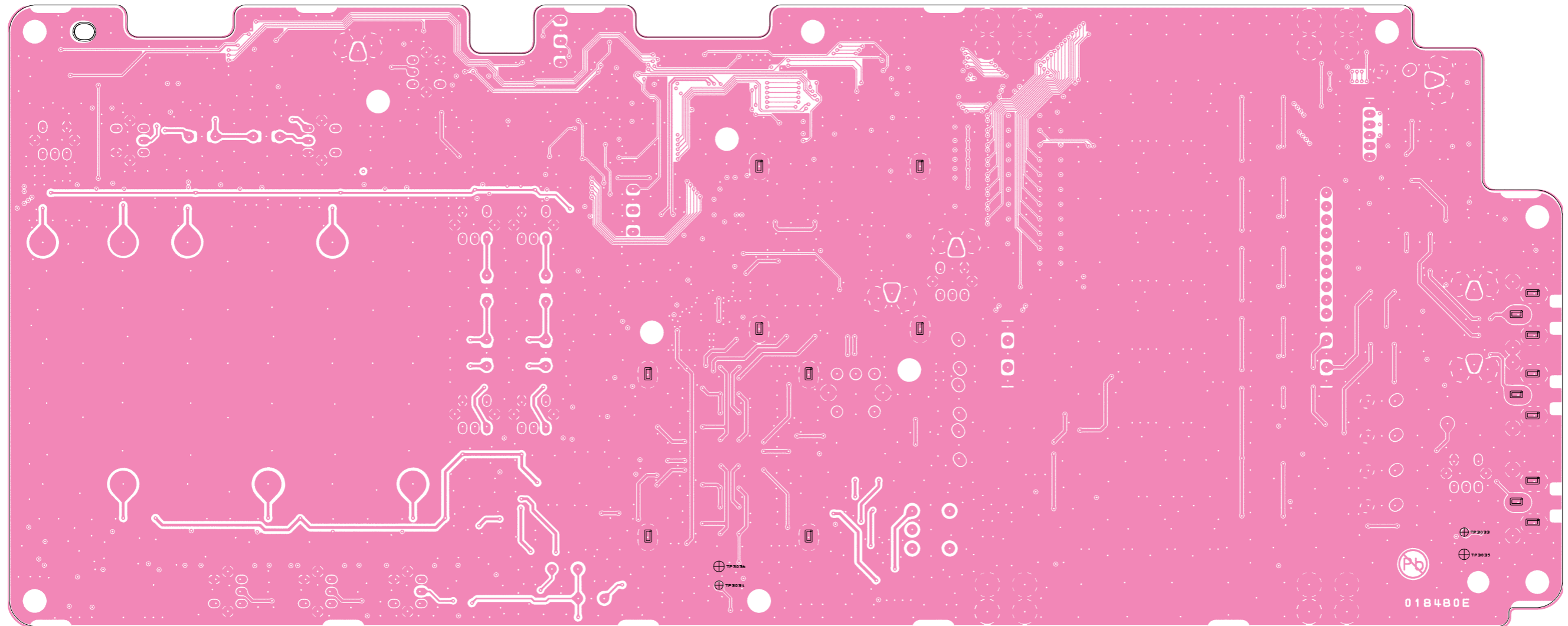

RX-1 Unit

Parts List

REF	DESCRIPTION	VALUE	V/W	TOL.	MFR'S DESIG	VXSTD P/N	VERS.	LOT	SIDE	LAY ADR
	PCB with Components					CS2076701	W/O FILTER			
	PCB with Components					CS2076702	W/ FILTER			
	PCB with Components					CS2076703	CE, W/O FILTER			
	PCB with Components					CS2076704	CE, W/ FILTER			
	Printed Circuit Board					FR018480C		1-		
	Printed Circuit Board					FR018480D		4-5		
	Printed Circuit Board					FR018480D	W/O CE LABEL	6-10		
	Printed Circuit Board					FR018480E	W/ CE LABEL	8-10		
	Printed Circuit Board					FR018480E		11-		
C 3001	CHIP CAP.	0.1uF	16V	B	GRM188B11C104KA01D	K22124805		1-	A	I1
C 3002	CHIP CAP.	0.01uF	50V	B	GRM188B11H103KA01D	K22174823		1-	A	A1
C 3003	CHIP CAP.	0.001uF	50V	B	GRM188B11H102KA01D	K22174821		1-	A	I1
C 3004	CHIP CAP.	0.1uF	16V	B	GRM188B11C104KA01D	K22124805		1-	A	I1
C 3005	CHIP CAP.	0.01uF	50V	B	GRM188B11H103KA01D	K22174823		1-	A	A1
C 3006	CHIP CAP.	0.001uF	50V	B	GRM188B11H102KA01D	K22174821		1-	A	I1
C 3007	CHIP CAP.	0.01uF	50V	B	GRM188B11H103KA01D	K22174823		1-	A	A2
C 3008	CHIP CAP.	0.01uF	50V	B	GRM188B11H103KA01D	K22174823		1-	A	A2
C 3009	CHIP CAP.	0.01uF	50V	B	GRM188B11H103KA01D	K22174823		1-	A	A2
C 3010	CHIP CAP.	0.01uF	50V	B	GRM188B11H103KA01D	K22174823		1-	A	B2
C 3011	CHIP CAP.	0.01uF	50V	B	GRM188B11H103KA01D	K22174823		1-	A	A3
C 3012	CHIP CAP.	0.01uF	50V	B	GRM188B11H103KA01D	K22174823		1-	A	A2
C 3013	CHIP CAP.	0.01uF	50V	B	GRM188B11H103KA01D	K22174823		1-	A	B2
C 3014	CHIP CAP.	0.01uF	50V	B	GRM188B11H103KA01D	K22174823		1-	A	A2
C 3015	CHIP CAP.	0.0027uF	50V	CH	GRM1882C1H272JA01D	K22174280		1-	A	A3
C 3016	CHIP CAP.	0.0012uF	50V	CH	GRM1882C1H122JA01D	K22174276		1-	A	B3
C 3017	CHIP CAP.	0.0012uF	50V	CH	GRM1882C1H122JA01D	K22174276		1-	A	B3
C 3018	CHIP CAP.	0.01uF	50V	B	GRM188B11H103KA01D	K22174823		1-	A	A3
C 3019	CHIP CAP.	0.01uF	50V	B	GRM188B11H103KA01D	K22174823		1-	A	A2
C 3020	CHIP CAP.	0.01uF	50V	B	GRM188B11H103KA01D	K22174823		1-	A	C3
C 3021	CHIP CAP.	0.01uF	50V	B	GRM188B11H103KA01D	K22174823		1-	A	C3
C 3022	CHIP CAP.	0.01uF	50V	B	GRM188B11H103KA01D	K22174823		1-	A	C2
C 3023	CHIP CAP.	0.01uF	50V	B	GRM188B11H103KA01D	K22174823		1-	A	C2
C 3024	CHIP CAP.	0.01uF	50V	B	GRM188B11H103KA01D	K22174823		1-	A	C1
C 3025	CHIP CAP.	0.01uF	50V	B	GRM188B11H103KA01D	K22174823		1-	A	C4
C 3026	CHIP CAP.	0.01uF	50V	B	GRM188B11H103KA01D	K22174823		1-	A	C4
C 3027	CHIP CAP.	0.0012uF	50V	CH	GRM1882C1H122JA01D	K22174276		1-	A	B4
C 3028	CHIP CAP.	0.01uF	50V	B	GRM188B11H103KA01D	K22174823		1-	A	B3
C 3029	CHIP CAP.	0.001uF	50V	B	GRM188B11H102KA01D	K22174821		1-	A	F1
C 3030	CHIP CAP.	0.01uF	50V	B	GRM188B11H103KA01D	K22174823		1-	A	E1
C 3031	CHIP CAP.	0.01uF	50V	B	GRM188B11H103KA01D	K22174823		1-	A	D4
C 3032	CHIP CAP.	0.01uF	50V	B	GRM188B11H103KA01D	K22174823		1-	A	D4
C 3033	CHIP CAP.	0.0027uF	50V	CH	GRM1882C1H272JA01D	K22174280		1-	A	B4
C 3034	CHIP CAP.	68pF	50V	CH	GRM1882C1H680JA01D	K22174231		1-	A	C3
C 3035	CHIP CAP.	330pF	50V	CH	GRM1882C1H331JA01D	K22174253		1-	A	C3
C 3036	CHIP CAP.	470pF	50V	CH	GRM1882C1H471JA01D	K22174249		1-	A	C2
C 3037	CHIP CAP.	560pF	50V	CH	GRM1882C1H561JA01D	K22174273		1-	A	C2
C 3038	CHIP CAP.	820pF	50V	CH	GRM1882C1H821JA01D	K22174283		1-	A	C1
C 3039	CHIP CAP.	0.001uF	50V	CH	GRM1882C1H102JA01D	K22174275		1-	A	C4
C 3041	CHIP CAP.	39pF	50V	CH	GRM1882C1H390JA01D	K22174225		1-	A	C3
C 3042	CHIP CAP.	39pF	50V	CH	GRM1882C1H390JA01D	K22174225		1-	A	C2
C 3043	CHIP CAP.	56pF	50V	CH	GRM1882C1H560JA01D	K22174229		1-	A	C1
C 3044	CHIP CAP.	39pF	50V	CH	GRM1882C1H390JA01D	K22174225		1-	A	C2
C 3046	CHIP CAP.	0.01uF	50V	B	GRM188B11H103KA01D	K22174823		1-	A	B2
C 3047	CHIP CAP.	0.01uF	50V	B	GRM188B11H103KA01D	K22174823		1-	A	B1
C 3048	CHIP CAP.	0.01uF	50V	B	GRM188B11H103KA01D	K22174823		1-	A	B1
C 3049	CHIP CAP.	0.001uF	50V	B	GRM188B11H102KA01D	K22174821		1-	A	B1
C 3050	CHIP CAP.	0.01uF	50V	B	GRM188B11H103KA01D	K22174823		1-	A	B1
C 3051	CHIP CAP.	0.001uF	50V	B	GRM188B11H102KA01D	K22174821		1-	A	B1
C 3052	CHIP CAP.	0.01uF	50V	B	GRM188B11H103KA01D	K22174823		1-	A	B1
C 3053	CHIP CAP.	0.001uF	50V	B	GRM188B11H102KA01D	K22174821		1-	A	B1
C 3054	CHIP CAP.	4pF	50V	CH	GRM1882C1H4R0CZ01D	K22174205		1-	A	C3
C 3055	CHIP CAP.	10pF	50V	CH	GRM1882C1H100JA01D	K22174211		1-	A	C2
C 3056	CHIP CAP.	4pF	50V	CH	GRM1882C1H4R0CZ01D	K22174205		1-	A	C2
C 3057	CHIP CAP.	8pF	50V	CH	GRM1882C1H8R0DZ01D	K22174209		1-	A	C2
C 3058	CHIP CAP.	33pF	50V	CH	GRM1882C1H330JA01D	K22174223		1-	A	C1
C 3059	CHIP CAP.	0.0039uF	50V	CH	GRM1882C1H392JA01D	K22174282		1-	A	C4
C 3060	CHIP CAP.	0.0015uF	50V	CH	GRM1882C1H152JA01D	K22174277		1-	A	C3
C 3061	CHIP CAP.	27pF	50V	CH	GRM1882C1H270JA01D	K22174221		1-	A	C3
C 3062	CHIP CAP.	68pF	50V	CH	GRM1882C1H680JA01D	K22174231		1-	A	C2
C 3063	CHIP CAP.	100pF	50V	CH	GRM1882C1H101JA01D	K22174235		1-	A	C2
C 3064	CHIP CAP.	150pF	50V	CH	GRM1882C1H151JA01D	K22174239		1-	A	C2
C 3065	CHIP CAP.	560pF	50V	CH	GRM1882C1H561JA01D	K22174273		1-	A	C1
C 3066	CHIP CAP.	220pF	50V	CH	GRM1882C1H221JA01D	K22174243		1-	A	C3

RX-1Unit

Parts List

REF	DESCRIPTION	VALUE	V/W	TOL.	MFR'S DESIG	VXSTD P/N	VERS.	LOT	SIDE	LAY ADR
C 3067	CHIP CAP.	0.0022uF	50V	CH	GRM1882C1H222JA01D	K22174279		1-	A	C4
C 3068	CHIP CAP.	220pF	50V	CH	GRM1882C1H221JA01D	K22174243		1-	A	C3
C 3069	CHIP CAP.	0.001uF	50V	CH	GRM1882C1H102JA01D	K22174275		1-	A	C3
C 3070	CHIP CAP.	0.0015uF	50V	CH	GRM1882C1H152JA01D	K22174277		1-	A	C2
C 3071	CHIP CAP.	0.0015uF	50V	CH	GRM1882C1H152JA01D	K22174277		1-	A	C2
C 3072	CHIP CAP.	0.0033uF	50V	CH	GRM1882C1H332JA01D	K22174281		1-	A	C1
C 3073	CHIP CAP.	27pF	50V	CH	GRM1882C1H270JA01D	K22174221		1-	A	C3
C 3074	CHIP CAP.	150pF	50V	CH	GRM1882C1H151JA01D	K22174239		1-	A	C3
C 3075	CHIP CAP.	68pF	50V	CH	GRM1882C1H680JA01D	K22174231		1-	A	C2
C 3076	CHIP CAP.	390pF	50V	CH	GRM1882C1H391JA01D	K22174255		1-	A	C2
C 3077	CHIP CAP.	56pF	50V	CH	GRM1882C1H560JA01D	K22174229		1-	A	C1
C 3078	CHIP CAP.	0.0039uF	50V	CH	GRM1882C1H392JA01D	K22174282		1-	A	C4
C 3079	CHIP CAP.	0.0012uF	50V	CH	GRM1882C1H122JA01D	K22174276		1-	A	C3
C 3080	CHIP CAP.	0.0033uF	50V	CH	GRM1882C1H332JA01D	K22174281		1-	A	C3
C 3081	CHIP CAP.	0.0022uF	50V	CH	GRM1882C1H222JA01D	K22174279		1-	A	C4
C 3082	CHIP CAP.	0.001uF	50V	B	GRM188B11H102KA01D	K22174821		1-	A	B2
C 3083	CHIP CAP.	0.001uF	50V	B	GRM188B11H102KA01D	K22174821		1-	A	B1
C 3084	CHIP CAP.	4pF	50V	CH	GRM1882C1H4R0CZ01D	K22174205		1-	A	C3
C 3085	CHIP CAP.	10pF	50V	CH	GRM1882C1H100JA01D	K22174211		1-	A	C2
C 3086	CHIP CAP.	4pF	50V	CH	GRM1882C1H4R0CZ01D	K22174205		1-	A	C2
C 3087	CHIP CAP.	8pF	50V	CH	GRM1882C1H8R0DZ01D	K22174209		1-	A	C2
C 3088	CHIP CAP.	33pF	50V	CH	GRM1882C1H330JA01D	K22174223		1-	A	C1
C 3089	CHIP CAP.	27pF	50V	CH	GRM1882C1H270JA01D	K22174221		1-	A	D3
C 3090	CHIP CAP.	27pF	50V	CH	GRM1882C1H270JA01D	K22174221		1-	A	C3
C 3091	CHIP CAP.	68pF	50V	CH	GRM1882C1H680JA01D	K22174231		1-	A	C2
C 3092	CHIP CAP.	100pF	50V	CH	GRM1882C1H101JA01D	K22174235		1-	A	C2
C 3093	CHIP CAP.	150pF	50V	CH	GRM1882C1H151JA01D	K22174239		1-	A	C2
C 3094	CHIP CAP.	560pF	50V	CH	GRM1882C1H561JA01D	K22174273		1-	A	C1
C 3096	CHIP CAP.	39pF	50V	CH	GRM1882C1H390JA01D	K22174225		1-	A	C3
C 3097	CHIP CAP.	39pF	50V	CH	GRM1882C1H390JA01D	K22174225		1-	A	C2
C 3098	CHIP CAP.	56pF	50V	CH	GRM1882C1H560JA01D	K22174229		1-	A	C2
C 3099	CHIP CAP.	39pF	50V	CH	GRM1882C1H390JA01D	K22174225		1-	A	C1
C 3100	CHIP CAP.	0.001uF	50V	CH	GRM1882C1H102JA01D	K22174275		1-	A	C4
C 3101	CHIP CAP.	27pF	50V	CH	GRM1882C1H270JA01D	K22174221		1-	A	D3
C 3102	CHIP CAP.	0.0015uF	50V	CH	GRM1882C1H152JA01D	K22174277		1-	A	C3
C 3103	CHIP CAP.	0.01uF	50V	B	GRM188B11H103JA01D	K22174824		1-	A	D4
C 3104	CHIP CAP.	68pF	50V	CH	GRM1882C1H680JA01D	K22174231		1-	A	C3
C 3105	CHIP CAP.	330pF	50V	CH	GRM1882C1H331JA01D	K22174253		1-	A	C3
C 3106	CHIP CAP.	470pF	50V	CH	GRM1882C1H471JA01D	K22174249		1-	A	C2
C 3107	CHIP CAP.	560pF	50V	CH	GRM1882C1H561JA01D	K22174273		1-	A	C2
C 3108	CHIP CAP.	820pF	50V	CH	GRM1882C1H821JA01D	K22174283		1-	A	C1
C 3109	CHIP CAP.	220pF	50V	CH	GRM1882C1H221JA01D	K22174243		1-	A	C3
C 3111	CHIP CAP.	0.01uF	50V	B	GRM188B11H103KA01D	K22174823		1-	A	H1
C 3112	CHIP CAP.	68pF	50V	CH	GRM1882C1H680JA01D	K22174231		1-	A	D3
C 3113	CHIP CAP.	27pF	50V	CH	GRM1882C1H270JA01D	K22174221		1-	A	D3
C 3114	CHIP TA.CAP.	10uF	16V		TEESVA1C106M8R	K78120077		1-	A	H1
C 3115	CHIP CAP.	82pF	50V	CH	GRM1882C1H820JA01D	K22174233		1-	A	D3
C 3116	CHIP CAP.	6pF	50V	CH	GRM1882C1H6R0DZ01D	K22174207		1-	A	D3
C 3117	CHIP CAP.	47pF	50V	CH	GRM1882C1H470JA01D	K22174227		1-	A	D3
C 3118	CHIP CAP.	82pF	50V	CH	GRM1882C1H820JA01D	K22174233		1-	A	D3
C 3119	CHIP CAP.	7pF	50V	CH	GRM1882C1H7R0DZ01D	K22174208		1-	A	D3
C 3120	CHIP CAP.	0.1uF	16V	B	GRM188B11C104KA01D	K22124805		1-	A	D4
C 3121	CHIP CAP.	0.1uF	16V	B	GRM188B11C104KA01D	K22124805		1-	A	E4
C 3122	CHIP CAP.	0.001uF	50V	B	GRM188B11H102KA01D	K22174821		1-	A	E4
C 3123	CHIP CAP.	150pF	50V	CH	GRM1882C1H151JA01D	K22174239		1-	A	D3
C 3124	CHIP CAP.	0.001uF	50V	B	GRM188B11H102KA01D	K22174821		1-	A	D4
C 3125	CHIP CAP.	18pF	50V	CH	GRM1882C1H180JA01D	K22174217		1-	A	D3
C 3126	CHIP CAP.	0.1uF	16V	B	GRM188B11C104KA01D	K22124805		1-	A	E4
C 3127	CHIP CAP.	0.1uF	16V	B	GRM188B11C104KA01D	K22124805		1-	A	E4
C 3128	CHIP CAP.	150pF	50V	CH	GRM1882C1H151JA01D	K22174239		1-	A	D3
C 3129	CHIP CAP.	0.001uF	50V	B	GRM188B11H102KA01D	K22174821		1-	A	E4
C 3130	CHIP CAP.	0.001uF	50V	B	GRM188B11H102KA01D	K22174821		1-	A	E4
C 3131	CHIP CAP.	39pF	50V	CH	GRM1882C1H390JA01D	K22174225		1-	A	D3
C 3132	CHIP CAP.	0.001uF	50V	B	GRM188B11H102KA01D	K22174821		1-	A	E4
C 3133	CHIP CAP.	0.1uF	16V	B	GRM188B11C104KA01D	K22124805		1-	A	E4
C 3134	CHIP CAP.	68pF	50V	CH	GRM1882C1H680JA01D	K22174231		1-	A	D3
C 3135	CHIP CAP.	0.1uF	16V	B	GRM188B11C104KA01D	K22124805		1-	A	E4
C 3136	CHIP CAP.	0.1uF	16V	B	GRM188B11C104KA01D	K22124805		1-	A	E4
C 3137	CHIP CAP.	0.001uF	50V	B	GRM188B11H102KA01D	K22174821		1-	A	E4
C 3138	CHIP CAP.	0.1uF	16V	B	GRM188B11C104KA01D	K22124805		1-	A	E4
C 3139	CHIP CAP.	0.1uF	16V	B	GRM188B11C104KA01D	K22124805		1-	A	E4
C 3140	CHIP CAP.	0.1uF	16V	B	GRM188B11C104KA01D	K22124805		1-	A	E4
C 3141	CHIP CAP.	0.01uF	50V	B	GRM188B11H103KA01D	K22174823		1-	A	E4

REF	DESCRIPTION	VALUE	V/W	TOL.	MFR'S DESIG	VXSTD P/N	VERS.	LOT	SIDE	LAY ADR
C 3142	CHIP CAP.	0.022uF	50V	CH	GRM21B2C1H223JA01L	K22170292		1-	A	G1
C 3143	CHIP CAP.	56pF	50V	CH	GRM1882C1H560JA01D	K22174229		1-	A	G1
C 3144	CHIP CAP.	330pF	50V	CH	GRM1882C1H331JA01D	K22174253		1-	A	D2
C 3145	CHIP CAP.	2pF	50V	CK	GRM1884C1H2R0CZ01D	K22174203		1-	A	E3
C 3146	CHIP CAP.	0.0027uF	50V	CH	GRM1882C1H272JA01D	K22174280		1-	A	E3
C 3147	CHIP CAP.	330pF	50V	CH	GRM1882C1H331JA01D	K22174253		1-	A	E3
C 3148	CHIP CAP.	330pF	50V	CH	GRM1882C1H331JA01D	K22174253		1-	A	D2
C 3150	CHIP CAP.	0.01uF	50V	B	GRM188B11H103KA01D	K22174823		1-	A	F3
C 3151	CHIP TA.CAP.	10uF	16V		TEESVA1C106M8R	K78120077		1-	A	G1
C 3152	CHIP CAP.	0.0027uF	50V	CH	GRM1882C1H272JA01D	K22174280		1-	A	E3
C 3153	CHIP CAP.	330pF	50V	CH	GRM1882C1H331JA01D	K22174253		1-	A	E3
C 3154	CHIP CAP.	0.01uF	50V	B	GRM188B11H103KA01D	K22174823		1-	A	F3
C 3155	CHIP CAP.	47pF	50V	CH	GRM1882C1H470JA01D	K22174227		1-	A	D2
C 3156	CHIP CAP.	0.01uF	50V	B	GRM188B11H103JA01D	K22174824		1-	A	E3
C 3157	CHIP TA.CAP.	10uF	16V		TEESVB21C106M8R	K78120025		1-	A	G3
C 3158	CHIP TA.CAP.	10uF	16V		TEESVA1C106M8R	K78120077		1-	A	G1
C 3159	CHIP CAP.	100pF	50V	CH	GRM1882C1H101JA01D	K22174235		1-	A	F3
C 3160	CHIP CAP.	0.1uF	16V	B	GRM188B11C104KA01D	K22124805		1-	A	F1
C 3161	CHIP TA.CAP.	10uF	16V		TEESVB21C106M8R	K78120025		1-	A	F3
C 3163	CHIP CAP.	0.01uF	50V	B	GRM188B11H103KA01D	K22174823		1-	A	D2
C 3164	CHIP CAP.	47pF	50V	CH	GRM1882C1H470JA01D	K22174227		1-	A	E3
C 3165	CHIP CAP.	2pF	50V	CK	GRM1884C1H2R0CZ01D	K22174203		1-	A	E3
C 3166	CHIP CAP.	47pF	50V	CH	GRM1882C1H470JA01D	K22174227		1-	A	E4
C 3167	CHIP CAP.	0.01uF	50V	B	GRM188B11H103KA01D	K22174823		1-	A	F3
C 3168	CHIP CAP.	0.001uF	50V	CH	GRM1882C1H102JA01D	K22174275		1-	A	G1
C 3169	CHIP CAP.	0.1uF	16V	B	GRM188B11C104KA01D	K22124805		1-	A	D2
C 3170	CHIP CAP.	10pF	50V	CH	GRM1882C1H100JA01D	K22174211		1-	A	E2
C 3171	CHIP CAP.	47pF	50V	CH	GRM1882C1H470JA01D	K22174227		1-	A	E2
C 3172	CHIP CAP.	0.001uF	50V	CH	GRM1882C1H102JA01D	K22174275		1-	A	G1
C 3173	CHIP CAP.	0.1uF	16V	B	GRM188B11C104KA01D	K22124805		1-	A	E2
C 3174	CHIP CAP.	0.001uF	50V	CH	GRM1882C1H102JA01D	K22174275		1-	A	G1
C 3175	CHIP CAP.	0.001uF	50V	B	GRM188B11H102KA01D	K22174821		1-	A	E2
C 3176	CHIP CAP.	0.01uF	50V	B	GRM188B11H103KA01D	K22174823		1-	A	E2
C 3177	CHIP CAP.	0.001uF	50V	CH	GRM1882C1H102JA01D	K22174275		1-	A	E2
C 3178	CHIP CAP.	0.047uF	25V	B	GRM188B11E473KA01D	K22144811		1-	A	F2
C 3179	CHIP CAP.	100pF	50V	CH	GRM1882C1H101JA01D	K22174235		1-	A	E2
C 3180	CHIP CAP.	0.022uF	50V	CH	GRM21B2C1H223JA01L	K22170292		1-	A	G1
C 3181	CHIP CAP.	0.1uF	16V	B	GRM188B11C104KA01D	K22124805		1-	A	E3
C 3182	CHIP CAP.	0.001uF	50V	B	GRM188B11H102KA01D	K22174821		1-	A	E3
C 3183	CHIP CAP.	0.001uF	50V	B	GRM188B11H102KA01D	K22174821		1-	A	E3
C 3184	CHIP CAP.	0.1uF	16V	B	GRM188B11C104KA01D	K22124805		1-	A	E3
C 3185	CHIP CAP.	0.1uF	16V	B	GRM188B11C104KA01D	K22124805		1-	A	E3
C 3186	CHIP CAP.	0.001uF	50V	B	GRM188B11H102KA01D	K22174821		1-	A	E4
C 3187	CHIP CAP.	0.001uF	50V	B	GRM188B11H102KA01D	K22174821		1-	A	E4
C 3188	CHIP CAP.	0.1uF	16V	B	GRM188B11C104KA01D	K22124805		1-	A	E4
C 3189	CHIP CAP.	0.001uF	50V	B	GRM188B11H102KA01D	K22174821		1-	A	F2
C 3191	CHIP CAP.	0.1uF	16V	B	GRM188B11C104KA01D	K22124805		1-	A	D1
C 3192	CHIP TA.CAP.	1uF	35V		TEESVA1V105M8R	K78160032		1-	A	H1
C 3193	CHIP CAP.	0.01uF	50V	CH	GRM2192C1H103JA01D	K22170291		1-	A	G1
C 3194	CHIP CAP.	0.01uF	50V	B	GRM188B11H103KA01D	K22174823		1-	A	E2
C 3195	AL.ELECTRO.CAP.	100uF	16V		EEE1CA101WP	K48120012		1-	A	G2
C 3196	CHIP CAP.	47pF	50V	CH	GRM1882C1H470JA01D	K22174227		1-	A	E2
C 3198	CHIP TA.CAP.	1uF	35V		TEESVA1V105M8R	K78160032		1-	A	E2
C 3199	CHIP CAP.	0.01uF	50V	B	GRM188B11H103KA01D	K22174823		1-	A	F3
C 3200	CHIP CAP.	0.01uF	50V	B	GRM188B11H103KA01D	K22174823		1-	A	F3
C 3201	CHIP CAP.	0.01uF	50V	B	GRM188B11H103KA01D	K22174823		1-	A	F3
C 3202	CHIP CAP.	0.01uF	50V	B	GRM188B11H103KA01D	K22174823		1-	A	F4
C 3203	CHIP CAP.	0.047uF	25V	B	GRM188B11E473KA01D	K22144811		1-	A	F2
C 3204	CHIP CAP.	470pF	50V	CH	GRM1882C1H471JA01D	K22174249		1-	A	E2
C 3205	CHIP CAP.	0.047uF	25V	B	GRM188B11E473KA01D	K22144811		1-	A	F4
C 3206	CHIP CAP.	0.047uF	25V	B	GRM188B11E473KA01D	K22144811		1-	A	F3
C 3207	CHIP CAP.	0.001uF	50V	B	GRM188B11H102KA01D	K22174821		1-	A	F4
C 3208	CHIP CAP.	0.01uF	50V	B	GRM188B11H103KA01D	K22174823		1-	A	E2
C 3209	CHIP CAP.	330pF	50V	CH	GRM1882C1H331JA01D	K22174253		1-	A	F2
C 3210	CHIP CAP.	0.001uF	50V	B	GRM188B11H102KA01D	K22174821		1-	A	F3
C 3211	CHIP CAP.	470pF	50V	CH	GRM1882C1H471JA01D	K22174249		1-	A	H1
C 3212	CHIP TA.CAP.	100uF	10V		TEESVD1A107M12R	K78100031		1-	A	E3
C 3213	CHIP TA.CAP.	10uF	16V		TEESVA1C106M8R	K78120077		1-	A	E3
C 3214	CHIP CAP.	0.01uF	50V	B	GRM188B11H103KA01D	K22174823		1-	A	E2
C 3215	CHIP CAP.	0.047uF	25V	B	GRM188B11E473KA01D	K22144811		1-	A	H1
C 3216	CHIP CAP.	0.01uF	50V	B	GRM188B11H103KA01D	K22174823		1-	A	F3
C 3217	CHIP CAP.	0.001uF	50V	B	GRM188B11H102KA01D	K22174821		1-	A	F3
C 3218	CHIP CAP.	0.001uF	50V	B	GRM188B11H102KA01D	K22174821		1-	A	F4

RX-1Unit

Parts List

REF	DESCRIPTION	VALUE	V/W	TOL.	MFR'S DESIG	VXSTD P/N	VERS.	LOT	SIDE	LAY ADR
C 3219	CHIP CAP.	0.1uF	16V	B	GRM188B11C104KA01D	K22124805		1-	A	F3
C 3221	CHIP CAP.	1uF	16V	B	C1608JB1C105KT	K22124813		1-	A	F1
C 3222	CHIP CAP.	0.1uF	16V	B	GRM188B11C104KA01D	K22124805		1-	A	F3
C 3223	CHIP CAP.	0.01uF	50V	B	GRM188B11H103KA01D	K22174823		1-	A	F3
C 3224	CHIP CAP.	0.01uF	50V	B	GRM188B11H103KA01D	K22174823		1-	A	E1
C 3225	CHIP TA.CAP.	0.47uF	35V		TEESVA1V474M8R	K78160029		1-	A	F2
C 3226	CHIP CAP.	0.1uF	16V	B	GRM188B11C104KA01D	K22124805		1-	A	F4
C 3227	CHIP CAP.	0.001uF	50V	B	GRM188B11H102KA01D	K22174821		1-	A	F3
C 3228	CHIP TA.CAP.	10uF	16V		TEESVA1C106M8R	K78120077		1-	A	F3
C 3229	CHIP CAP.	0.01uF	50V	B	GRM188B11H103JA01D	K22174824		1-	A	E2
C 3230	CHIP TA.CAP.	10uF	16V		TEESVA1C106M8R	K78120077		1-	A	F4
C 3231	CHIP CAP.	0.047uF	25V	B	GRM188B11E473KA01D	K22144811		1-	A	H1
C 3232	CHIP CAP.	0.1uF	16V	B	GRM188B11C104KA01D	K22124805		1-	A	E1
C 3234	CHIP CAP.	0.01uF	50V	CH	GRM2192C1H103JA01D	K22170291		1-	A	F4
C 3235	CHIP CAP.	10uF	10V	B	GRM21BB31A106KE18L	K22100808		1-	A	F3
C 3236	CHIP TA.CAP.	0.33uF	35V		TEESVA1V334M8R	K78160028		1-	A	F3
C 3237	CHIP CAP.	2pF	50V	CK	GRM1884C1H2R0CZ01D	K22174203		1-	A	F3
C 3238	CHIP CAP.	0.047uF	25V	B	GRM188B11E473KA01D	K22144811		1-	A	G4
C 3239	CHIP CAP.	27pF	50V	CH	GRM1882C1H270JA01D	K22174221		1-	A	H1
C 3240	CHIP CAP.	0.047uF	25V	B	GRM188B11E473KA01D	K22144811		1-	A	H1
C 3241	CHIP CAP.	0.01uF	50V	B	GRM188B11H103KA01D	K22174823		1-	A	G4
C 3242	CHIP CAP.	0.01uF	50V	CH	GRM2192C1H103JA01D	K22170291		1-	A	E2
C 3244	CHIP TA.CAP.	10uF	16V		TEESVA1C106M8R	K78120077		1-	A	I4
C 3245	CHIP CAP.	0.047uF	25V	B	GRM188B11E473KA01D	K22144811		1-	A	I4
C 3246	CHIP TA.CAP.	0.47uF	35V		TEESVA1V474M8R	K78160029		1-	A	F1
C 3247	CHIP CAP.	0.01uF	50V	B	GRM188B11H103KA01D	K22174823		1-	A	F3
C 3248	CHIP CAP.	0.001uF	50V	CH	GRM1882C1H102JA01D	K22174275		1-	A	E2
C 3249	CHIP CAP.	2pF	50V	CK	GRM1884C1H2R0CZ01D	K22174203		1-	A	I1
C 3250	CHIP CAP.	27pF	50V	CH	GRM1882C1H270JA01D	K22174221		1-	A	H4
C 3251	CHIP CAP.	0.047uF	25V	B	GRM188B11E473KA01D	K22144811		1-	A	G4
C 3253	CHIP CAP.	0.1uF	16V	B	GRM188B11C104KA01D	K22124805		1-	A	G4
C 3254	CHIP CAP.	0.001uF	50V	CH	GRM1882C1H102JA01D	K22174275		1-	A	E2
C 3255	CHIP CAP.	0.047uF	25V	B	GRM188B11E473KA01D	K22144811		1-	A	H1
C 3256	CHIP CAP.	15pF	50V	CH	GRM1882C1H150JA01D	K22174215		1-	A	H4
C 3257	CHIP CAP.	0.001uF	50V	CH	GRM1882C1H102JA01D	K22174275		1-	A	E2
C 3258	CHIP CAP.	0.1uF	16V	B	GRM188B11C104KA01D	K22124805		1-	A	G2
C 3259	CHIP CAP.	0.1uF	16V	B	GRM188B11C104KA01D	K22124805		1-	A	F1
C 3260	CHIP TA.CAP.	0.1uF	35V		TEESVA1V104M8R	K78160025		1-	A	I4
C 3261	CHIP CAP.	0.047uF	25V	B	GRM188B11E473KA01D	K22144811		1-	A	H4
C 3262	CHIP CAP.	33pF	50V	CH	GRM1882C1H330JA01D	K22174223		1-	A	H1
C 3263	CHIP TA.CAP.	10uF	16V		TEESVA1C106M8R	K78120077		1-	A	G2
C 3264	CHIP CAP.	2pF	50V	CK	GRM1884C1H2R0CZ01D	K22174203		1-	A	G4
C 3265	CHIP CAP.	0.01uF	50V	B	GRM188B11H103KA01D	K22174823		1-	A	H4
C 3266	CHIP CAP.	390pF	50V	CH	GRM1882C1H391JA01D	K22174255		1-	A	E2
C 3267	CHIP CAP.	0.001uF	50V	B	GRM188B11H102KA01D	K22174821		1-	A	E2
C 3267	CHIP CAP.	0.01uF	50V	B	GRM188B11H103KA01D	K22174823		4-	A	E2
C 3268	CHIP CAP.	27pF	50V	CH	GRM1882C1H270JA01D	K22174221		1-	A	I1
C 3269	CHIP CAP.	0.047uF	25V	B	GRM188B11E473KA01D	K22144811		1-	A	I1
C 3270	CHIP CAP.	0.047uF	25V	B	GRM188B11E473KA01D	K22144811		1-	A	H1
C 3272	AL.ELECTRO.CAP.	47uF	16V		EEE1CA470SP	K48120005		1-	A	F1
C 3273	CHIP CAP.	180pF	50V	CH	GRM1882C1H181JA01D	K22174241		1-	A	E2
C 3274	CHIP CAP.	0.01uF	50V	B	GRM188B11H103KA01D	K22174823		1-	A	J1
C 3275	AL.ELECTRO.CAP.	47uF	16V		EEE1CA470WR	K48120025		1-	A	F2
C 3276	AL.ELECTRO.CAP.	47uF	16V		EEE1CA470WR	K48120025		1-	A	F2
C 3277	CHIP TA.CAP.	0.47uF	25V		TEESVA1E474M8R	K78140009		1-	A	J2
C 3278	CHIP CAP.	27pF	50V	CH	GRM1882C1H270JA01D	K22174221		1-	A	H4
C 3279	CHIP CAP.	0.047uF	25V	B	GRM188B11E473KA01D	K22144811		1-	A	H4
C 3280	CHIP CAP.	0.1uF	16V	B	GRM188B11C104KA01D	K22124805		1-	A	F2
C 3281	CHIP CAP.	390pF	50V	CH	GRM1882C1H391JA01D	K22174255		1-	A	E2
C 3282	CHIP CAP.	0.047uF	25V	B	GRM188B11E473KA01D	K22144811		1-	A	H1
C 3283	CHIP CAP.	0.01uF	50V	B	GRM188B11H103KA01D	K22174823		1-	A	J1
C 3284	CHIP CAP.	0.01uF	50V	CH	GRM2192C1H103JA01D	K22170291		1-	A	G4
C 3285	CHIP CAP.	0.001uF	50V	CH	GRM1882C1H102JA01D	K22174275		1-	A	H1
C 3286	CHIP CAP.	15pF	50V	CH	GRM1882C1H150JA01D	K22174215		1-	A	H4
C 3287	CHIP CAP.	0.047uF	25V	B	GRM188B11E473KA01D	K22144811		1-	A	H4
C 3288	AL.ELECTRO.CAP.	100uF	16V		EEE1CA101WP	K48120012		1-	A	I4
C 3289	CHIP CAP.	0.1uF	16V	B	GRM188B11C104KA01D	K22124805		1-	A	G4
C 3290	CHIP CAP.	100pF	50V	CH	GRM1882C1H101JA01D	K22174235		1-	A	J1
C 3291	CHIP TA.CAP.	10uF	16V		TEESVA1C106M8R	K78120077		1-	A	I4
C 3292	CHIP CAP.	0.01uF	50V	B	GRM188B11H103JA01D	K22174824		1-	A	G2
C 3293	CHIP CAP.	0.001uF	50V	B	GRM188B11H102KA01D	K22174821		1-	A	G4
C 3294	CHIP CAP.	0.1uF	16V	B	GRM188B11C104KA01D	K22124805		1-	A	J4
C 3295	CHIP CAP.	0.001uF	50V	B	GRM188B11H102KA01D	K22174821		1-	A	G3

RX-1 Unit

Parts List

REF	DESCRIPTION	VALUE	V/W	TOL.	MFR'S DESIG	VXSTD P/N	VERS.	LOT	SIDE	LAY ADR
C 3296	CHIP CAP.	0.01uF	50V	CH	GRM2192C1H103JA01D	K22170291		1-	A	G4
C 3297	CHIP CAP.	0.0015uF	50V	CH	GRM1882C1H152JA01D	K22174277		1-	A	G2
C 3298	CHIP CAP.	0.1uF	16V	B	GRM188B11C104KA01D	K22124805		1-	A	G3
C 3299	CHIP CAP.	0.01uF	50V	B	GRM188B11H103KA01D	K22174823		1-	A	H4
C 3300	CHIP CAP.	0.01uF	50V	B	GRM188B11H103JA01D	K22174824		1-	A	G2
C 3301	CHIP CAP.	0.047uF	25V	B	GRM188B11E473KA01D	K22144811		1-	A	J1
C 3302	CHIP CAP.	0.1uF	16V	B	GRM188B11C104KA01D	K22124805		1-	A	G3
C 3303	CHIP CAP.	0.01uF	50V	B	GRM188B11H103KA01D	K22174823		1-	A	J4
C 3304	CHIP CAP.	27pF	50V	CH	GRM1882C1H270JA01D	K22174221		1-	A	J2
C 3305	CHIP CAP.	0.027uF	25V	B	GRM188B11E273KA01D	K22144810		1-	A	G2
C 3306	CHIP CAP.	27pF	50V	CH	GRM1882C1H270JA01D	K22174221		1-	A	I4
C 3307	CHIP CAP.	0.047uF	25V	B	GRM188B11E473KA01D	K22144811		1-	A	I4
C 3308	CHIP CAP.	0.047uF	25V	B	GRM188B11E473KA01D	K22144811		1-	A	J2
C 3309	CHIP CAP.	27pF	50V	CH	GRM1882C1H270JA01D	K22174221		1-	A	G2
C 3310	CHIP CAP.	27pF	50V	CH	GRM1882C1H270JA01D	K22174221		1-	A	G2
C 3311	CHIP CAP.	0.047uF	25V	B	GRM188B11E473KA01D	K22144811		1-	A	H2
C 3312	CHIP CAP.	0.047uF	25V	B	GRM188B11E473KA01D	K22144811		1-	A	G2
C 3313	CHIP CAP.	0.047uF	25V	B	GRM188B11E473KA01D	K22144811		1-	A	G2
C 3314	CHIP CAP.	0.047uF	25V	B	GRM188B11E473KA01D	K22144811		1-	A	I2
C 3315	CHIP CAP.	0.047uF	25V	B	GRM188B11E473KA01D	K22144811		1-	A	H2
C 3316	CHIP CAP.	15pF	50V	CH	GRM1882C1H150JA01D	K22174215		1-	A	I4
C 3316	CHIP CAP.	15pF	50V	CH	GRM1882C1H150JA01D	K22174215		8-	A	I4
C 3317	CHIP CAP.	0.001uF	50V	CH	GRM1882C1H102JA01D	K22174275		1-	A	J2
C 3318	CHIP CAP.	0.1uF	16V	B	GRM188B11C104KA01D	K22124805		1-	A	G1
C 3319	CHIP CAP.	0.01uF	50V	B	GRM188B11H103JA01D	K22174824		1-	A	G1
C 3320	CHIP CAP.	0.1uF	16V	B	GRM188B11C104KA01D	K22124805		1-	A	F2
C 3321	CHIP CAP.	6pF	50V	CH	GRM1882C1H6R0DZ01D	K22174207		1-	A	G3
C 3322	CHIP CAP.	10pF	50V	CH	GRM1882C1H100JA01D	K22174211		1-	A	G3
C 3323	CHIP CAP.	0.001uF	50V	CH	GRM1882C1H102JA01D	K22174275		1-	A	I2
C 3324	CHIP CAP.	0.001uF	50V	CH	GRM1882C1H102JA01D	K22174275		1-	A	H2
C 3325	CHIP CAP.	0.047uF	25V	B	GRM188B11E473KA01D	K22144811		1-	A	J2
C 3326	CHIP CAP.	0.022uF	50V	B	GRM188B11H223KA01D	K22174839		1-	A	G3
C 3327	AL.ELECTRO.CAP.	47uF	16V		EEE1CA470SP	K48120005		1-	A	F1
C 3328	CHIP CAP.	33pF	50V	CH	GRM1882C1H330JA01D	K22174223		1-	A	G3
C 3329	CHIP CAP.	0.01uF	50V	B	GRM188B11H103KA01D	K22174823		1-	A	J4
C 3330	CHIP CAP.	0.047uF	25V	B	GRM188B11E473KA01D	K22144811		1-	A	G2
C 3331	CHIP CAP.	0.047uF	25V	B	GRM188B11E473KA01D	K22144811		1-	A	G2
C 3332	CHIP CAP.	0.0033uF	50V	B	GRM188B11H332KA01D	K22174815		1-	A	G1
C 3333	AL.ELECTRO.CAP.	47uF	16V		EEE1CA470WR	K48120025		1-	A	F3
C 3334	CHIP TA.CAP.	0.1uF	35V		TEESVA1V104M8R	K78160025		1-	A	F2
C 3335	CHIP CAP.	0.01uF	50V	B	GRM188B11H103KA01D	K22174823		1-	A	I4
C 3336	CHIP CAP.	0.047uF	25V	B	GRM188B11E473KA01D	K22144811		1-	A	I2
C 3337	CHIP TA.CAP.	0.1uF	35V		TEESVA1V104M8R	K78160025		1-	A	F2
C 3338	CHIP CAP.	0.1uF	16V	B	GRM188B11C104KA01D	K22124805		1-	A	I4
C 3339	CHIP TA.CAP.	1uF	35V		TEESVA1V105M8R	K78160032		1-	A	G1
C 3340	CHIP CAP.	0.047uF	25V	B	GRM188B11E473KA01D	K22144811		1-	A	J4
C 3341	CHIP CAP.	0.01uF	50V	B	GRM188B11H103KA01D	K22174823		1-	A	F2
C 3343	CHIP CAP.	0.047uF	25V	B	GRM188B11E473KA01D	K22144811		1-	A	F3
C 3344	CHIP TA.CAP.	4.7uF	16V		TEESVA1C475M8R	K78120031		1-	A	G4
C 3345	CHIP CAP.	0.001uF	50V	CH	GRM1882C1H102JA01D	K22174275		1-	A	G3
C 3346	CHIP CAP.	0.001uF	50V	CH	GRM1882C1H102JA01D	K22174275		1-	A	G3
C 3347	AL.ELECTRO.CAP.	47uF	16V		EEE1CA470WR	K48120025		1-	A	F2
C 3348	CHIP TA.CAP.	10uF	16V		TEESVA1C106M8R	K78120077		1-	A	G1
C 3349	AL.ELECTRO.CAP.	47uF	16V		EEE1CA470WR	K48120025		1-	A	F2
C 3350	CHIP TA.CAP.	1uF	25V		TEESVA1E105M8R	K78140013		1-	A	J4
C 3351	CHIP CAP.	0.047uF	25V	B	GRM188B11E473KA01D	K22144811		1-	A	G3
C 3352	CHIP CAP.	0.047uF	25V	B	GRM188B11E473KA01D	K22144811		1-	A	G3
C 3353	CHIP CAP.	0.047uF	25V	B	GRM188B11E473KA01D	K22144811		1-	A	G4
C 3354	CHIP CAP.	0.01uF	50V	CH	GRM2192C1H103JA01D	K22170291		1-	A	G4
C 3355	CHIP CAP.	27pF	50V	CH	GRM1882C1H270JA01D	K22174221		1-	A	G3
C 3356	CHIP CAP.	27pF	50V	CH	GRM1882C1H270JA01D	K22174221		1-	A	G3
C 3357	CHIP CAP.	0.001uF	50V	CH	GRM1882C1H102JA01D	K22174275		1-	A	H4
C 3358	CHIP CAP.	0.001uF	50V	CH	GRM1882C1H102JA01D	K22174275		1-	A	H4
C 3359	CHIP CAP.	0.001uF	50V	CH	GRM1882C1H102JA01D	K22174275		1-	A	I4
C 3360	CHIP TA.CAP.	1uF	16V		TEESVA21C105M8R	K78120024		1-	A	F2
C 3361	CHIP TA.CAP.	10uF	16V		TEESVA1C106M8R	K78120077		1-	A	G4
C 3362	CHIP CAP.	0.001uF	50V	B	GRM188B11H102KA01D	K22174821		1-	A	I4
C 3364	CHIP TA.CAP.	0.22uF	35V		TEESVA1V224M8R	K78160027		1-	A	G1
C 3365	CHIP TA.CAP.	0.1uF	35V		TEESVA1V104M8R	K78160025		1-	A	F2
C 3366	CHIP TA.CAP.	10uF	16V		TEESVA1C106M8R	K78120077		1-	A	G4
C 3367	CHIP CAP.	0.047uF	25V	B	GRM188B11E473KA01D	K22144811		1-	A	H4
C 3368	CHIP CAP.	0.047uF	25V	B	GRM188B11E473KA01D	K22144811		1-	A	I4
C 3369	CHIP CAP.	0.047uF	25V	B	GRM188B11E473KA01D	K22144811		1-	A	I4

RX-1Unit

Parts List

REF	DESCRIPTION	VALUE	V/W	TOL.	MFR'S DESIG	VXSTD P/N	VERS.	LOT	SIDE	LAY ADR
C 3370	CHIP TA.CAP.	0.1uF	35V		TEESVA1V104M8R	K78160025		1-	A	F2
C 3371	CHIP TA.CAP.	1uF	16V		TEESVA21C105M8R	K78120024		1-	A	F2
C 3372	CHIP CAP.	0.047uF	25V	B	GRM188B11E473KA01D	K22144811		1-	A	G1
C 3373	CHIP TA.CAP.	0.1uF	35V		TEESVA1V104M8R	K78160025		1-	A	F2
C 3374	CHIP CAP.	0.1uF	16V	B	GRM188B11C104KA01D	K22124805		1-	A	G4
C 3375	AL.ELECTRO.CAP.	47uF	16V		EEE1CA470SP	K48120005		1-	A	H1
C 3376	CHIP CAP.	0.01uF	50V	B	GRM188B11H103KA01D	K22174823		1-	A	J1
C 3378	CHIP CAP.	0.01uF	50V	B	GRM188B11H103KA01D	K22174823		1-	A	G1
C 3378	CHIP CAP.	0.1uF	16V	B	GRM188B11C104KA01D	K22124805		5-	A	G1
C 3379	CHIP CAP.	0.001uF	50V	B	GRM188B11H102KA01D	K22174821		1-	A	J1
C 3380	CHIP CAP.	100pF	50V	CH	GRM1882C1H101JA01D	K22174235		1-	A	A3
C 3381	CHIP CAP.	100pF	50V	CH	GRM1882C1H101JA01D	K22174235		1-	A	A4
C 3382	CHIP CAP.	0.001uF	50V	B	GRM188B11H102KA01D	K22174821		1-	A	E4
C 3383	CHIP CAP.	0.001uF	50V	B	GRM188B11H102KA01D	K22174821		1-	A	E4
C 3384	CHIP CAP.	2pF	50V	CK	GRM1884C1H2R0CZ01D	K22174203		1-	A	F4
C 3385	CHIP CAP.	0.01uF	50V	B	GRM188B11H103KA01D	K22174823		1-	A	F4
C 3386	CHIP CAP.	22pF	50V	CH	GRM1882C1H220JA01D	K22174219		1-	A	A4
C 3387	CHIP CAP.	0.047uF	25V	B	GRM188B11E473KA01D	K22144811		1-	A	A3
C 3388	CHIP CAP.	0.01uF	50V	B	GRM188B11H103KA01D	K22174823		1-	A	A3
C 3389	CHIP CAP.	0.047uF	25V	B	GRM188B11E473KA01D	K22144811		1-	A	A3
C 3390	CHIP CAP.	22pF	50V	CH	GRM1882C1H220JA01D	K22174219		1-	A	D3
C 3391	CHIP CAP.	0.047uF	25V	B	GRM188B11E473KA01D	K22144811		1-	A	I2
C 3392	CHIP CAP.	0.047uF	25V	B	GRM188B11E473KA01D	K22144811		1-	A	F1
C 3393	CHIP CAP.	0.22uF	16V	B	GRM188B11C224KA01D	K22124815		1-	A	F1
C 3394	CHIP CAP.	0.1uF	16V	B	GRM188B11C104KA01D	K22124805		4-	A	E2
C 3395	CHIP CAP.	0.1uF	16V	B	GRM188B11C104KA01D	K22124805		1-	A	F3
C 3396	CHIP CAP.	10pF	50V	CH	GRM1882C1H100JA01D	K22174211		2-7	A	D4
C 3396	CHIP CAP.	10pF	50V	CH	GRM1882C1H100JA01D	K22174211	W/ CE LABEL	8-	A	D4
C 3396	CHIP CAP.	10pF	50V	CH	GRM1882C1H100JA01D	K22174211	W/O CE LABEL	8-	A	D4
C 3397	AL.ELECTRO.CAP.	470uF	16V		RE3-16V471MG3#	K40129066	W/ CE LABEL	8-	A	A3
C 3397	AL.ELECTRO.CAP.	470uF	16V		RE3-16V471MG3#	K40129066	W/O CE LABEL	11-	A	A3
D 3001	SURGE ABSORBER				1608SGX	Q9000891		1-	A	A1
D 3002	DIODE				BAS316	G2070716		1-	A	A1
D 3003	DIODE				BAS316	G2070716		1-	A	A1
D 3004	DIODE				BAS316	G2070716		1-	A	A2
D 3005	DIODE				BAS316	G2070716		1-	A	A2
D 3006	DIODE				BAS316	G2070716		1-	A	A2
D 3007	DIODE				BAS316	G2070716		1-	A	B2
D 3008	DIODE				BAS316	G2070716		1-	A	A2
D 3009	DIODE				BAS316	G2070716		1-	A	A2
D 3010	DIODE				BAS316	G2070716		1-	A	B2
D 3011	DIODE				BAS316	G2070716		1-	A	A3
D 3012	DIODE				BAS316	G2070716		1-	A	A3
D 3013	DIODE				BAS316	G2070716		1-	A	A2
D 3014	DIODE				BAS316	G2070716		1-	A	B3
D 3015	DIODE				BAS316	G2070716		1-	A	B3
D 3016	DIODE				BAS316	G2070716		1-	A	B2
D 3017	DIODE				BAS316	G2070716		1-	A	B2
D 3018	DIODE				BAS316	G2070716		1-	A	B1
D 3019	DIODE				BAS316	G2070716		1-	A	B4
D 3020	DIODE				BAS316	G2070716		1-	A	B4
D 3021	DIODE				BAS316	G2070716		1-	A	B3
D 3022	DIODE				BAS316	G2070716		1-	A	D4
D 3023	DIODE				BAS316	G2070716		1-	A	D4
D 3024	DIODE				BAS316	G2070716		1-	A	D4
D 3025	DIODE				BAS316	G2070716		1-	A	D2
D 3026	DIODE				BAS316	G2070716		1-	A	D2
D 3027	DIODE				BAS316	G2070716		1-	A	D2
D 3028	DIODE				BAS316	G2070716		1-	A	D1
D 3029	DIODE				BAS316	G2070716		1-	A	D1
D 3030	DIODE				BAS316	G2070716		1-	A	D1
D 3031	DIODE				BAS316	G2070716		1-	A	D1
D 3032	DIODE				BAS316	G2070716		1-	A	D2
D 3033	DIODE				BAS316	G2070716		1-	A	D2
D 3034	DIODE				RN142S TE61	G2070994		1-	A	D2
D 3035	DIODE				BAS316	G2070716		1-	A	E4
D 3036	DIODE				BAS316	G2070716		1-	A	G3
D 3037	DIODE				HSM198S TR-E	G2070570		1-	A	E2
D 3038	DIODE				HSB88WS TR-E	G2070290		1-	A	H1
D 3039	DIODE				JDP2S04E(TAPE)	G2071180		1-	A	H2
D 3040	DIODE				BAS316	G2070716		1-	A	F1
D 3041	DIODE				BAS316	G2070716		1-	A	F3
D 3042	DIODE				JDP2S04E(TAPE)	G2071180		1-	A	E2

RX-1 Unit

Parts List

REF	DESCRIPTION	VALUE	V/W	TOL.	MFR'S DESIG	VXSTD P/N	VERS.	LOT	SIDE	LAY ADR
D 3043	DIODE				JDP2S04E(TAPE)	G2071180		1-	A	E2
D 3044	DIODE				JDP2S04E(TAPE)	G2071180		1-	A	E2
D 3045	DIODE				RN142S TE61	G2070994		1-	A	G2
D 3046	DIODE				RN142S TE61	G2070994		1-	A	G2
D 3047	DIODE				RN142S TE61	G2070994		1-	A	I2
D 3048	DIODE				RN142S TE61	G2070994		1-	A	J2
D 3049	DIODE				BAS316	G2070716		1-	A	J4
D 3050	DIODE				BAS316	G2070716		1-	A	J4
D 3051	DIODE				BAS316	G2070716		1-	A	J4
D 3052	DIODE				RN142S TE61	G2070994		1-	A	G3
D 3053	DIODE				RN142S TE61	G2070994		1-	A	H2
D 3054	DIODE				RN142S TE61	G2070994		1-	A	G3
D 3056	DIODE				BAS316	G2070716		1-	A	J4
D 3057	DIODE				1SS372(TE85R.F)	G2070632		1-	A	I4
D 3058	DIODE				RN142S TE61	G2070994		1-	A	G3
D 3059	DIODE				RN142S TE61	G2070994		1-	A	G3
D 3060	DIODE				RN142S TE61	G2070994		1-	A	G4
D 3061	DIODE				RN142S TE61	G2070994		1-	A	H4
D 3062	DIODE				RN142S TE61	G2070994		1-	A	I4
D 3063	DIODE				BAS316	G2070716		1-	A	E1
D 3066	DIODE				BAS316	G2070716		1-	A	E1
FB3001	FERRITE BEADS				BLM18BD182SN1D	L1690602		1-	A	F1
FB3002	FERRITE BEADS				BLM18BD182SN1D	L1690602		1-	A	F1
J 3001	CONNECTOR				TMP-J01X-V6	P1090210		1-	A	A1
J 3002	CONNECTOR				JPJ2545-01-510	P1090633		1-	A	A3
J 3003	CONNECTOR				JPJ2545-01-510	P1090633		1-	A	A2
J 3004	CONNECTOR				18FLT-SM2-TB(LF)(SN)(M)	P1091176		1-	A	I1
J 3005	CONNECTOR				TMP-J01X-V6	P1090210		1-	A	A3
J 3006	CONNECTOR				TMP-J01X-V6	P1090210		1-	A	A2
J 3007	CONNECTOR				30FLT-SM2-TB(LF)(SN)(M)	P1091142		1-	A	F1
J 3008	CONNECTOR				SB20-06WS	P0090613		1-	A	B1
J 3009	CONNECTOR				IMSA6065B-15-Z075-PT1	P0091417		1-	A	B2
J 3010	TERMINAL				P07	Q5000166		1-	A	D1
J 3011	TERMINAL				P07	Q5000166		1-	A	D4
J 3012	CONNECTOR				IMSA6065B-05-Z075-PT1	P0091416		1-	A	D3
J 3013	TERMINAL				P07	Q5000166		1-	A	B4
J 3014	TERMINAL				P07	Q5000166		1-	A	B1
J 3015	CONNECTOR				TMP-J01X-V6	P1090210		1-	A	D2
J 3016	CONNECTOR				SB20-05WS	P0090612		1-	A	G1
J 3017	CONNECTOR				SB20-05WS	P0090612		1-	A	F2
J 3018	CONNECTOR				TMP-J01X-V6	P1090210		1-	A	E2
J 3019	CONNECTOR				TMP-J01X-V6	P1090210		1-	A	H1
J 3020	CONNECTOR				JPJ2545-01-510	P1090633		1-	A	A4
J 3023	SOCKET PIN				PD-72	Q5000169		1-		
J 3024	SOCKET PIN				PD-72	Q5000169		1-		
J 3025	SOCKET PIN				PD-72	Q5000169		1-		
JP3001	WIRE ASSY				GRN 85 2/2	T50508500		1-3		
L 3001	M.RFC	1000uH		5%	EL0606RA-102J-PF	L1790300		1-	A	B1
L 3002	M.RFC	3.9uH		5%	EL0606RA-3R9J-PF	L1790271		1-	A	B3
L 3003	M.RFC	3.3uH		5%	EL0606RA-3R3J-PF	L1790270		1-	A	B3
L 3004	M.RFC	3.3uH		5%	EL0606RA-3R3J-PF	L1790270		1-	A	B3
L 3005	M.RFC	3.9uH		5%	EL0606RA-3R9J-PF	L1790271		1-	A	B4
L 3006	CHIP COIL	0.22uH		2%	C2520C-R22G-RA	L1691298		1-	A	C3
L 3007	CHIP COIL	0.47uH		2%	C2520C-R47G-RA	L1691302		1-	A	C3
L 3008	CHIP COIL	0.68uH		2%	C2520C-R68G-RA	L1691305		1-	A	C2
L 3009	CHIP COIL	1.2uH		2%	C2520C-1R2G-RA	L1691310		1-	A	C2
L 3010	CHIP COIL	4.7uH		2%	C2520C-4R7G-RA	L1691317		1-	A	C1
L 3011	CHIP COIL	0.56uH		2%	C2520C-R56G-RA	L1691303		1-	A	C3
L 3012	CHIP COIL	2.2uH		2%	C2520C-2R2G-RA	L1691313		1-	A	C2
L 3013	CHIP COIL	3.3uH		2%	C2520C-3R3G-RA	L1691315		1-	A	C2
L 3014	CHIP COIL	4.7uH		2%	C2520C-4R7G-RA	L1691317		1-	A	C2
L 3015	M.RFC	6.8uH			LLM3225-6R8J	L1691131		1-	A	C1
L 3016	M.RFC	10uH			LLM3225-100J	L1691133		1-	A	C4
L 3017	M.RFC	22uH			LLM3225-220J	L1691137		1-	A	C4
L 3018	CHIP COIL	0.068uH		2%	C2520C-68NG-RA	L1691292		1-	A	C3
L 3019	CHIP COIL	0.15uH		2%	C2520C-R15G-RA	L1691296		1-	A	C3
L 3020	CHIP COIL	0.22uH		2%	C2520C-R22G-RA	L1691298		1-	A	C2
L 3021	CHIP COIL	0.39uH		2%	C2520C-R39G-RA	L1691301		1-	A	C2
L 3022	CHIP COIL	1.2uH		2%	C2520C-1R2G-RA	L1691310		1-	A	C1
L 3023	M.RFC	8.2uH			LLM3225-8R2J	L1691132		1-	A	C3
L 3024	M.RFC	18uH			LLM3225-180J	L1691136		1-	A	C4
L 3025	CHIP COIL	0.56uH		2%	C2520C-R56G-RA	L1691303		1-	A	C3
L 3026	CHIP COIL	2.2uH		2%	C2520C-2R2G-RA	L1691313		1-	A	C2

RX-1Unit

Parts List

REF	DESCRIPTION	VALUE	V/W	TOL.	MFR'S DESIG	VXSTD P/N	VERS.	LOT	SIDE	LAY ADR
L 3027	CHIP COIL	3.3uH		2%	C2520C-3R3G-RA	L1691315		1-	A	C2
L 3028	CHIP COIL	4.7uH		2%	C2520C-4R7G-RA	L1691317		1-	A	C2
L 3029	M.RFC	6.8uH			LLM3225-6R8J	L1691131		1-	A	C1
L 3030	M.RFC	10uH			LLM3225-100J	L1691133		1-	A	C4
L 3031	M.RFC	22uH			LLM3225-220J	L1691137		1-	A	C4
L 3032	CHIP COIL	0.1uH		2%	C2520C-R10G-RA	L1691294		1-	A	D3
L 3033	CHIP COIL	0.22uH		2%	C2520C-R22G-RA	L1691298		1-	A	C3
L 3034	CHIP COIL	0.47uH		2%	C2520C-R47G-RA	L1691302		1-	A	C3
L 3035	CHIP COIL	0.68uH		2%	C2520C-R68G-RA	L1691305		1-	A	C2
L 3036	CHIP COIL	1.2uH		2%	C2520C-1R2G-RA	L1691310		1-	A	C2
L 3037	CHIP COIL	4.7uH		2%	C2520C-4R7G-RA	L1691317		1-	A	C1
L 3038	CHIP COIL	0.15uH		2%	C2520C-R15G-RA	L1691296		1-	A	D3
L 3039	CHIP COIL	0.15uH		2%	C2520C-R15G-RA	L1691296		1-	A	D3
L 3040	M.RFC	0.33uH		10%	EL0606RA-R33K-PF	L1790258		1-	A	D3
L 3041	M.RFC	47uH			LLM3225-470J	L1691141		1-	A	D4
L 3042	M.RFC	47uH			LLM3225-470J	L1691141		1-	A	E4
L 3043	M.RFC	0.33uH		10%	EL0606RA-R33K-PF	L1790258		1-	A	D3
L 3044	M.RFC	0.22uH		10%	EL0606RA-R22K-PF	L1790256		1-	A	D3
L 3045	CHIP COIL	0.18uH		2%	C2520C-R18G-RA	L1691297		1-	A	E2
L 3046	M.RFC	1000uH			LLM3225-102J	L1691157		1-	A	G1
L 3047	CHIP COIL	0.18uH		2%	C2520C-R18G-RA	L1691297		1-	A	E2
L 3048	CHIP COIL	4.7uH		2%	C2520C-4R7G-RA	L1691317		1-	A	E2
L 3049	M.RFC	100uH			LLM3225-101J	L1691145		1-	A	G2
L 3050	CHIP COIL	0.47uH		2%	C2520C-R47G-RA	L1691302		1-	A	E2
L 3051	CHIP COIL	0.47uH		2%	C2520C-R47G-RA	L1691302		1-	A	E2
L 3052	M.RFC	47uH			LLM3225-470J	L1691141		1-	A	G4
L 3053	M.RFC	100uH			LLM3225-101J	L1691145		1-	A	J2
L 3054	M.RFC	100uH			LLM3225-101J	L1691145		1-	A	I2
L 3055	M.RFC	100uH			LLM3225-101J	L1691145		1-	A	H2
L 3056	M.RFC	100uH			LLM3225-101J	L1691145		1-	A	H4
L 3057	M.RFC	100uH			LLM3225-101J	L1691145		1-	A	H4
L 3058	M.RFC	100uH			LLM3225-101J	L1691145		1-	A	I4
L 3059	M.RFC	47uH			LLM3225-470J	L1691141		1-	A	A4
L 3060	CHIP COIL	0.22uH		2%	C2520C-R22G-RA	L1691298		1-	A	D3
Q 3001	TRANSISTOR				DTC114EUA T106	G3070084		1-	A	A1
Q 3002	TRANSISTOR				DTC114EUA T106	G3070084		1-	A	A1
Q 3003	TRANSISTOR				DTC114EUA T106	G3070084		1-	A	A2
Q 3004	TRANSISTOR				DTC114EUA T106	G3070084		1-	A	B2
Q 3005	TRANSISTOR				DTC114EUA T106	G3070084		1-	A	A3
Q 3006	TRANSISTOR				DTC143ZE TL	G3070102		1-	A	J2
Q 3007	TRANSISTOR				DTC143ZE TL	G3070102		1-	A	I2
Q 3008	TRANSISTOR				DTC143ZE TL	G3070102		1-	A	H2
Q 3009	TRANSISTOR				DTC143ZE TL	G3070102		1-	A	G2
Q 3010	TRANSISTOR				DTC143ZE TL	G3070102		1-	A	G2
Q 3011	TRANSISTOR				EMD30(T2R)	G3070427		1-	A	C1
Q 3012	TRANSISTOR				2SC4536-T1-AZ QR	G3345368R		1-	A	D4
Q 3013	TRANSISTOR				2SC4536-T1-AZ QR	G3345368R		1-	A	E4
Q 3014	TRANSISTOR				UMD5N TR	G3070343		1-	A	D2
Q 3015	TRANSISTOR				EMD30(T2R)	G3070427		1-	A	C1
Q 3016	TRANSISTOR				UMD5N TR	G3070343		1-	A	D2
Q 3017	TRANSISTOR				UMD5N TR	G3070343		1-	A	D1
Q 3018	TRANSISTOR				UMD5N TR	G3070343		1-	A	D2
Q 3019	TRANSISTOR				UMD5N TR	G3070343		1-	A	D2
Q 3020	FET				2SK508-T2B K52 A	G3805087B		1-	A	D2
Q 3021	TRANSISTOR				UMD5N TR	G3070343		1-	A	D2
Q 3022	IC				SN74HCT04PWR	G1094484		1-	A	G1
Q 3023	TRANSISTOR				UMD5N TR	G3070343		1-	A	D1
Q 3024	FET				2SK508-T2B K52 A	G3805087B		1-	A	E2
Q 3025	TRANSISTOR				UMD5N TR	G3070343		1-	A	D2
Q 3026	IC				LM2904PWR	G1094010		1-	A	H1
Q 3027	TRANSISTOR				UMD5N TR	G3070343		1-	A	D1
Q 3028	IC				BU2152FS(TAPE)	G1093942		1-	A	D1
Q 3029	TRANSISTOR				UMD5N TR	G3070343		1-	A	D2
Q 3030	TRANSISTOR				UMD5N TR	G3070343		1-	A	D1
Q 3031	TRANSISTOR				UMD5N TR	G3070343		1-	A	D2
Q 3032	FET				3SK294(TE85L)	G4802948		1-	A	F3
Q 3033	FET				3SK294(TE85L)	G4802948		1-	A	F3
Q 3034	IC				LM2904PWR	G1094010		1-	A	F3
Q 3035	FET				3SK294(TE85L)	G4802948		1-	A	F3
Q 3036	FET				3SK294(TE85L)	G4802948		1-	A	F3
Q 3037	IC				NJM2068V-TE1	G1094112		1-	A	G1
Q 3038	FET				3SK294(TE85L)	G4802948		1-	A	F3
Q 3039	FET				3SK294(TE85L)	G4802948		1-	A	F4

RX-1 Unit

Parts List

REF	DESCRIPTION	VALUE	V/W	TOL.	MFR'S DESIG	VXSTD P/N	VERS.	LOT	SIDE	LAY ADR
Q 3040	FET				3SK294(TE85L)	G4802948		1-	A	F4
Q 3041	FET				3SK294(TE85L)	G4802948		1-	A	F4
Q 3042	TRANSISTOR				DTC114EUA T106	G3070084		1-	A	F1
Q 3043	TRANSISTOR				UMD5N TR	G3070343		1-	A	D2
Q 3044	TRANSISTOR				UMD5N TR	G3070343		1-	A	D1
Q 3045	TRANSISTOR				2SC4081 T106 R	G3340818R		1-	A	E2
Q 3046	TRANSISTOR				UMD5N TR	G3070343		1-	A	D2
Q 3047	IC				PQ1LAX95MSPQ	G1094692		1-	A	F2
Q 3048	TRANSISTOR				UMD5N TR	G3070343		1-	A	D2
Q 3049	IC				LM2904PWR	G1094010		1-	A	E2
Q 3050	IC				BU2152FS(TAPE)	G1093942		1-	A	E1
Q 3051	TRANSISTOR				UMD5N TR	G3070343		1-	A	D1
Q 3052	FET				2SK209GR TE85R	G3802097G		1-	A	F1
Q 3052	FET				2SK209GR(TE85L.F)	G3802098G		16-	A	F1
Q 3053	FET				BF1201WR_115	G3070425		1-	A	G4
Q 3054	TRANSISTOR				2SC5415E-TD-E	G3354158E		1-	A	E2
Q 3055	IC				TC7W53FU(TE12L_F)	G1094158		1-	A	F1
Q 3056	TRANSISTOR				2SC4081 T106 R	G3340818R		1-	A	I4
Q 3057	TRANSISTOR				DTC114EUA T106	G3070084		1-	A	F3
Q 3058	FET				BF1201WR_115	G3070425		1-	A	H4
Q 3059	TRANSISTOR				2SC2714Y(TE85R.F)	G3327147Y		1-	A	H1
Q 3060	FET				BF1201WR_115	G3070425		1-	A	J1
Q 3061	TRANSISTOR				2SC4081 T106 R	G3340818R		1-	A	I4
Q 3062	IC				NJM2737V(TAPE)	G1094292		1-	A	F2
Q 3063	TRANSISTOR				2SC4536-T1-AZ QR	G3345368R		1-	A	G4
Q 3064	FET				BF1201WR_115	G3070425		1-	A	H4
Q 3065	TRANSISTOR				2SA1576A T106 R	G3115768R		1-	A	J4
Q 3066	IC				BU2505FV-E2	G1093714		1-	A	F2
Q 3067	TRANSISTOR				2SC2714Y(TE85R.F)	G3327147Y		1-	A	I4
Q 3068	TRANSISTOR				2SA1576A T106 R	G3115768R		1-	A	J4
Q 3069	TRANSISTOR				2SC4081 T106 R	G3340818R		1-	A	J4
Q 3070	IC				M51132FP 600C	G1091930		1-	A	F2
Q 3071	TRANSISTOR				2SC4081 T106 R	G3340818R		1-	A	G1
Q 3072	TRANSISTOR				2SC4081 T106 R	G3340818R		1-	A	J4
Q 3073	IC				SN74LVC2G66DCTR	G1094049		1-	A	I4
Q 3074	IC				NJM2737V(TAPE)	G1094292		1-	A	G1
Q 3075	IC				NJM2737V(TAPE)	G1094292		1-	A	J1
Q 3076	IC				TC7W53FU(TE12L_F)	G1094158		1-	A	I1
Q 3077	TRANSISTOR				DTC114WUA T106	G3070118		1	A	H1
Q 3077	TRANSISTOR				GA4L4K-T1-A/JM	G3070443		2-	A	H1
Q 3078	FET				SST310-T1	G4070009		1-	A	A4
Q 3079	FET				SST310-T1	G4070009		1-	A	A4
R 3001	CHIP RES.	470	1/16W	5%	RMC1/16 471JATP	J24185471		1-	A	I1
R 3002	CHIP RES.	470	1/16W	5%	RMC1/16 471JATP	J24185471		1-	A	I1
R 3003	CHIP RES.	470	1/16W	5%	RMC1/16 471JATP	J24185471		1-	A	A1
R 3004	CHIP RES.	100	1/16W	5%	RMC1/16 101JATP	J24185101		1-	A	A1
R 3005	CHIP RES.	47	1/16W	5%	RMC1/16 470JATP	J24185470		1-	A	A1
R 3006	CHIP RES.	100	1/16W	5%	RMC1/16 101JATP	J24185101		1-	A	A1
R 3007	CHIP RES.	68	1/16W	5%	RMC1/16 680JATP	J24185680		1-	A	A1
R 3008	CHIP RES.	150	1/16W	5%	RMC1/16 151JATP	J24185151		1-	A	A1
R 3009	CHIP RES.	100	1/16W	5%	RMC1/16 101JATP	J24185101		1-	A	A2
R 3010	CHIP RES.	150	1/16W	5%	RMC1/16 151JATP	J24185151		1-	A	A2
R 3011	CHIP RES.	68	1/16W	5%	RMC1/16 680JATP	J24185680		1-	A	A2
R 3012	CHIP RES.	470	1/16W	5%	RMC1/16 471JATP	J24185471		1-	A	F1
R 3013	CHIP RES.	100	1/16W	5%	RMC1/16 101JATP	J24185101		1-	A	B2
R 3014	CHIP RES.	100	1/16W	5%	RMC1/16 101JATP	J24185101		1-	A	A2
R 3015	CHIP RES.	100	1/16W	5%	RMC1/16 101JATP	J24185101		1-	A	A2
R 3016	CHIP RES.	470	1/16W	5%	RMC1/16 471JATP	J24185471		1-	A	F1
R 3017	CHIP RES.	470	1/16W	5%	RMC1/16 471JATP	J24185471		1-	A	F1
R 3018	CHIP RES.	470	1/16W	5%	RMC1/16 471JATP	J24185471		1-	A	F1
R 3019	CHIP RES.	0	1/16W	5%	RMC1/16 000JATP	J24185000		1-	A	F1
R 3020	CHIP RES.	0	1/16W	5%	RMC1/16 000JATP	J24185000		1-	A	F1
R 3021	CHIP RES.	47k	1/16W	5%	RMC1/16 473JATP	J24185473		1-	A	J2
R 3022	CHIP RES.	100	1/16W	5%	RMC1/16 101JATP	J24185101		1-	A	A3
R 3023	CHIP RES.	100	1/16W	5%	RMC1/16 101JATP	J24185101		1-	A	A2
R 3024	CHIP RES.	100	1/16W	5%	RMC1/16 101JATP	J24185101		1-	A	B3
R 3025	CHIP RES.	100	1/16W	5%	RMC1/16 101JATP	J24185101		1-	A	B3
R 3026	CHIP RES.	100	1/16W	5%	RMC1/16 101JATP	J24185101		1-	A	B2
R 3027	CHIP RES.	100	1/16W	5%	RMC1/16 101JATP	J24185101		1-	A	B2
R 3028	CHIP RES.	100	1/16W	5%	RMC1/16 101JATP	J24185101		1-	A	B1
R 3029	CHIP RES.	100	1/16W	5%	RMC1/16 101JATP	J24185101		1-	A	B4
R 3030	CHIP RES.	100	1/16W	5%	RMC1/16 101JATP	J24185101		1-	A	B4
R 3031	CHIP RES.	100	1/16W	5%	RMC1/16 101JATP	J24185101		1-	A	D4

RX-1Unit

Parts List

REF	DESCRIPTION	VALUE	V/W	TOL.	MFR'S DESIG	VXSTD P/N	VERS.	LOT	SIDE	LAY ADR
R 3032	CHIP RES.	47k	1/16W	5%	RMC1/16 473JATP	J24185473		1-	A	I2
R 3033	CHIP RES.	100	1/16W	5%	RMC1/16 101JATP	J24185101		1-	A	B3
R 3034	CHIP RES.	100	1/16W	5%	RMC1/16 101JATP	J24185101		1-	A	C4
R 3035	CHIP RES.	27	1/16W	5%	RMC1/16 270JATP	J24185270		1-	A	C3
R 3036	CHIP RES.	33	1/16W	5%	RMC1/16 330JATP	J24185330		1-	A	C3
R 3037	CHIP RES.	27	1/16W	5%	RMC1/16 270JATP	J24185270		1-	A	C3
R 3038	CHIP RES.	47k	1/16W	5%	RMC1/16 473JATP	J24185473		1-	A	H2
R 3039	CHIP RES.	0	1/16W	5%	RMC1/16 000JATP	J24185000		1-	A	I1
R 3040	CHIP RES.	0	1/16W	5%	RMC1/16 000JATP	J24185000		1-	A	I1
R 3041	CHIP RES.	47k	1/16W	5%	RMC1/16 473JATP	J24185473		1-	A	G2
R 3042	CHIP RES.	10	1/16W	5%	RMC1/16 100JATP	J24185100		1-	A	H1
R 3044	CHIP RES.	100	1/16W	5%	RMC1/16 101JATP	J24185101		1-	A	D4
R 3045	CHIP RES.	47k	1/16W	5%	RMC1/16 473JATP	J24185473		1-	A	G2
R 3046	CHIP RES.	1k	1/16W	5%	RMC1/16 102JATP	J24185102		1-	A	D4
R 3047	CHIP RES.	1k	1/16W	5%	RMC1/16 102JATP	J24185102		1-	A	E4
R 3048	CHIP RES.	47	1/10W	5%	RMC1/10T 470J	J24205470		1-	A	D4
R 3049	CHIP RES.	47	1/10W	5%	RMC1/10T 470J	J24205470		1-	A	E4
R 3050	CHIP RES.	0	1/16W	5%	RMC1/16 000JATP	J24185000		1-	A	E4
R 3050	CHIP RES.	33	1/16W	5%	RMC1/16 330JATP	J24185330		5-	A	E4
R 3051	CHIP RES.	330	1/16W	5%	RMC1/16 331JATP	J24185331		1-	A	E4
R 3052	CHIP RES.	0	1/16W	5%	RMC1/16 000JATP	J24185000		1-	A	E4
R 3052	CHIP RES.	33	1/16W	5%	RMC1/16 330JATP	J24185330		14-	A	E4
R 3053	CHIP RES.	330	1/16W	5%	RMC1/16 331JATP	J24185331		1-	A	E4
R 3054	CHIP RES.	1.8k	1/10W	5%	RMC1/10T 182J	J24205182		1-	A	E4
R 3055	CHIP RES.	1.8k	1/10W	5%	RMC1/10T 182J	J24205182		1-	A	E4
R 3057	CHIP RES.	0	1/16W	5%	RMC1/16 000JATP	J24185000		1-	A	E4
R 3059	CHIP RES.	1k	1/16W	5%	RMC1/16 102JATP	J24185102		1-	A	E4
R 3060	CHIP RES.	0	1/16W	5%	RMC1/16 000JATP	J24185000		1-	A	E4
R 3063	CHIP RES.	10	1/16W	5%	RMC1/16 100JATP	J24185100		1-	A	E4
R 3063	CHIP RES.	33	1/16W	5%	RMC1/16 330JATP	J24185330		14-	A	E4
R 3066	CHIP RES.	1k	1/16W	5%	RMC1/16 102JATP	J24185102		1-	A	E4
R 3067	CHIP RES.	0	1/16W	5%	RMC1/16 000JATP	J24185000		1-	A	G1
R 3068	CHIP RES.	68k	1/16W	5%	RMC1/16 683JATP	J24185683		1-	A	G1
R 3069	CHIP RES.	220k	1/16W	5%	RMC1/16 224JATP	J24185224		1-	A	F3
R 3070	CHIP RES.	47	1/16W	5%	RMC1/16 470JATP	J24185470		1-	A	G1
R 3071	CHIP RES.	330k	1/16W	5%	RMC1/16 334JATP	J24185334		1-	A	G3
R 3072	CHIP RES.	220	1/16W	5%	RMC1/16 221JATP	J24185221		1-	A	D2
R 3073	CHIP RES.	27	1/16W	5%	RMC1/16 270JATP	J24185270		1-	A	D2
R 3074	CHIP RES.	10k	1/16W	5%	RMC1/16 103JATP	J24185103		1-	A	G1
R 3075	CHIP RES.	10	1/16W	5%	RMC1/16 100JATP	J24185100		1-	A	E3
R 3076	CHIP RES.	100	1/16W	5%	RMC1/16 101JATP	J24185101		1-	A	E3
R 3077	CHIP RES.	100	1/16W	5%	RMC1/16 101JATP	J24185101		1-	A	F3
R 3078	CHIP RES.	47	1/16W	5%	RMC1/16 470JATP	J24185470		1-	A	G1
R 3079	CHIP RES.	47	1/16W	5%	RMC1/16 470JATP	J24185470		1-	A	F3
R 3080	CHIP RES.	47	1/16W	5%	RMC1/16 470JATP	J24185470		1-	A	F3
R 3081	CHIP RES.	100	1/16W	5%	RMC1/16 101JATP	J24185101		1-	A	E3
R 3082	CHIP RES.	680k	1/16W	5%	RMC1/16 684JATP	J24185684		1-	A	G3
R 3083	CHIP RES.	100	1/16W	5%	RMC1/16 101JATP	J24185101		1-	A	E3
R 3084	CHIP RES.	100k	1/16W	5%	RMC1/16 104JATP	J24185104		1-	A	D2
R 3085	CHIP RES.	0	1/16W	5%	RMC1/16 000JATP	J24185000		1-	A	E3
R 3086	CHIP RES.	2.2k	1/16W	5%	RMC1/16 222JATP	J24185222		1-	A	D2
R 3087	CHIP RES.	100	1/16W	5%	RMC1/16 101JATP	J24185101		1-	A	D2
R 3088	CHIP RES.	39k	1/16W	5%	RMC1/16 393JATP	J24185393		1-	A	G1
R 3089	CHIP RES.	0	1/16W	5%	RMC1/16 000JATP	J24185000		1-	A	G1
R 3090	CHIP RES.	100	1/16W	5%	RMC1/16 101JATP	J24185101		1-	A	D2
R 3091	CHIP RES.	0	1/16W	5%	RMC1/16 000JATP	J24185000		1-	A	F1
R 3092	CHIP RES.	100k	1/16W	5%	RMC1/16 104JATP	J24185104		1-	A	E2
R 3093	CHIP RES.	2.2k	1/16W	5%	RMC1/16 222JATP	J24185222		1-	A	G1
R 3094	CHIP RES.	0	1/16W	5%	RMC1/16 000JATP	J24185000		1-	A	F1
R 3095	CHIP RES.	22k	1/16W	5%	RMC1/16 223JATP	J24185223		1-	A	G3
R 3096	CHIP RES.	100	1/16W	5%	RMC1/16 101JATP	J24185101		1-	A	E2
R 3097	CHIP RES.	5.6k	1/16W	5%	RMC1/16 562JATP	J24185562		1-	A	G1
R 3099	CHIP RES.	0	1/16W	5%	RMC1/16 000JATP	J24185000		1-	A	G1
R 3100	CHIP RES.	220k	1/16W	5%	RMC1/16 224JATP	J24185224		1-	A	G3
R 3101	CHIP RES.	100	1/16W	5%	RMC1/16 101JATP	J24185101		1-	A	E2
R 3102	CHIP RES.	22k	1/16W	1%	RMC1/16 223FTP	J24183223		1-	A	G3
R 3103	CHIP RES.	100	1/16W	5%	RMC1/16 101JATP	J24185101		1-	A	F3
R 3105	CHIP RES.	4.7k	1/16W	5%	RMC1/16 472JATP	J24185472		1-	A	H1
R 3106	CHIP RES.	33	1/16W	5%	RMC1/16 330JATP	J24185330		1-	A	F3
R 3107	CHIP RES.	33	1/16W	5%	RMC1/16 330JATP	J24185330		1-	A	F3
R 3108	CHIP RES.	33	1/16W	5%	RMC1/16 330JATP	J24185330		1-	A	F4
R 3109	CHIP RES.	33	1/16W	5%	RMC1/16 330JATP	J24185330		1-	A	F4
R 3110	CHIP RES.	12k	1/16W	1%	RMC1/16 123FTP	J24183123		1-	A	G3

RX-1 Unit

Parts List

REF	DESCRIPTION	VALUE	V/W	TOL.	MFR'S DESIG	VXSTD P/N	VERS.	LOT	SIDE	LAY ADR
R 3111	CHIP RES.	22k	1/16W	5%	RMC1/16 223JATP	J24185223		1-	A	F2
R 3112	CHIP RES.	100k	1/16W	5%	RMC1/16 104JATP	J24185104		1-	A	F2
R 3113	CHIP RES.	1k	1/16W	5%	RMC1/16 102JATP	J24185102		1-	A	E2
R 3114	CHIP RES.	4.7k	1/16W	5%	RMC1/16 472JATP	J24185472		1-	A	F2
R 3115	CHIP RES.	470	1/16W	5%	RMC1/16 471JATP	J24185471		1-	A	E1
R 3117	CHIP RES.	470	1/16W	5%	RMC1/16 471JATP	J24185471		1-	A	D1
R 3118	CHIP RES.	0	1/16W	5%	RMC1/16 000JATP	J24185000		1-	A	F3
R 3119	CHIP RES.	470	1/16W	5%	RMC1/16 471JATP	J24185471		1-	A	E1
R 3120	CHIP RES.	0	1/16W	5%	RMC1/16 000JATP	J24185000		1-	A	F3
R 3121	CHIP RES.	100k	1/16W	5%	RMC1/16 104JATP	J24185104		1-	A	F3
R 3123	CHIP RES.	10k	1/16W	5%	RMC1/16 103JATP	J24185103		1-	A	F2
R 3124	CHIP RES.	22k	1/16W	5%	RMC1/16 223JATP	J24185223		1-	A	F3
R 3125	CHIP RES.	390	1/16W	5%	RMC1/16 391JATP	J24185391		1-	A	F4
R 3126	CHIP RES.	390	1/16W	5%	RMC1/16 391JATP	J24185391		1-	A	F4
R 3127	CHIP RES.	100k	1/16W	5%	RMC1/16 104JATP	J24185104		1-	A	F2
R 3127	CHIP RES.	100k	1/16W	1%	RMC1/16 104FTP	J24183104		4-	A	F2
R 3128	CHIP RES.	390	1/16W	5%	RMC1/16 391JATP	J24185391		1-	A	F3
R 3129	CHIP RES.	390	1/16W	5%	RMC1/16 391JATP	J24185391		1-	A	F3
R 3130	CHIP RES.	470	1/16W	5%	RMC1/16 471JATP	J24185471		1-	A	E2
R 3130	CHIP RES.	10k	1/16W	5%	RMC1/16 103JATP	J24185103		4-	A	E2
R 3131	CHIP RES.	22k	1/16W	5%	RMC1/16 223JATP	J24185223		1-	A	H1
R 3132	CHIP RES.	0	1/16W	5%	RMC1/16 000JATP	J24185000		1-	A	F3
R 3133	CHIP RES.	1k	1/16W	5%	RMC1/16 102JATP	J24185102		1-	A	H1
R 3134	CHIP RES.	4.7	1/16W	5%	RMC1/16 4R7JATP	J24185479		1-	A	F3
R 3135	CHIP RES.	33k	1/16W	5%	RMC1/16 333JATP	J24185333		1-	A	F2
R 3135	CHIP RES.	30k	1/16W	1%	RMC1/16 303FTP	J24183303		4-	A	F2
R 3136	CHIP RES.	100	1/16W	5%	RMC1/16 101JATP	J24185101		1-	A	F3
R 3137	CHIP RES.	2.2k	1/16W	5%	RMC1/16 222JATP	J24185222		1-	A	F1
R 3138	CHIP RES.	100	1/16W	5%	RMC1/16 101JATP	J24185101		1-	A	F3
R 3139	CHIP RES.	4.7	1/16W	5%	RMC1/16 4R7JATP	J24185479		1-	A	F4
R 3140	CHIP RES.	10k	1/16W	5%	RMC1/16 103JATP	J24185103		1-	A	F2
R 3141	CHIP RES.	10k	1/16W	1%	RMC1/16 103FTP	J24183103		1-	A	F2
R 3142	CHIP RES.	10	1/16W	5%	RMC1/16 100JATP	J24185100		1-	A	E3
R 3143	CHIP RES.	22k	1/16W	5%	RMC1/16 223JATP	J24185223		1-	A	H1
R 3144	CHIP RES.	4.7k	1/16W	5%	RMC1/16 472JATP	J24185472		1-	A	F1
R 3145	CHIP RES.	33	1/2W	5%	RMC1/2 330JCTP	J24275330		1-	A	F2
R 3146	CHIP RES.	2.2M	1/16W	5%	RMC1/16 225JATP	J24185225		1-	A	F2
R 3147	CHIP RES.	39k	1/16W	1%	RMC1/16 393FTP	J24183393		1-	A	F2
R 3148	CHIP RES.	68k	1/16W	5%	RMC1/16 683JATP	J24185683		1-	A	F1
R 3149	CHIP RES.	10	1/16W	5%	RMC1/16 100JATP	J24185100		1-	A	E1
R 3150	CHIP RES.	1k	1/16W	5%	RMC1/16 102JATP	J24185102		1-	A	H1
R 3151	CHIP RES.	100k	1/16W	5%	RMC1/16 104JATP	J24185104		1-	A	F2
R 3152	CHIP RES.	470	1/16W	5%	RMC1/16 471JATP	J24185471		1-	A	E1
R 3154	CHIP RES.	470	1/16W	5%	RMC1/16 471JATP	J24185471		1-	A	E1
R 3155	CHIP RES.	68	1/16W	5%	RMC1/16 680JATP	J24185680		1-	A	E2
R 3156	CHIP RES.	100k	1/16W	5%	RMC1/16 104JATP	J24185104		1-	A	F1
R 3157	CHIP RES.	470	1/16W	5%	RMC1/16 471JATP	J24185471		1-	A	E1
R 3158	CHIP RES.	2.2k	1/16W	5%	RMC1/16 222JATP	J24185222		1-	A	H1
R 3159	CHIP RES.	150k	1/16W	5%	RMC1/16 154JATP	J24185154		1-	A	G4
R 3160	CHIP RES.	68	1/16W	5%	RMC1/16 680JATP	J24185680		1-	A	E2
R 3161	CHIP RES.	470	1/16W	5%	RMC1/16 471JATP	J24185471		1-	A	G4
R 3162	CHIP RES.	100k	1/16W	5%	RMC1/16 104JATP	J24185104		1-	A	F1
R 3163	CHIP RES.	1k	1/16W	5%	RMC1/16 102JATP	J24185102		1-	A	E2
R 3164	CHIP RES.	100	1/16W	5%	RMC1/16 101JATP	J24185101		1-	A	G4
R 3165	CHIP RES.	10	1/16W	5%	RMC1/16 100JATP	J24185100		1-	A	F1
R 3166	CHIP RES.	330	1/16W	5%	RMC1/16 331JATP	J24185331		1-	A	E2
R 3167	CHIP RES.	10k	1/16W	5%	RMC1/16 103JATP	J24185103		1-	A	G4
R 3168	CHIP RES.	10k	1/16W	5%	RMC1/16 103JATP	J24185103		1-	A	I4
R 3169	CHIP RES.	2.2k	1/16W	5%	RMC1/16 222JATP	J24185222		1-	A	E2
R 3170	CHIP RES.	100	1/16W	5%	RMC1/16 101JATP	J24185101		1-	A	H4
R 3171	CHIP RES.	100	1/16W	5%	RMC1/16 101JATP	J24185101		1-	A	I1
R 3172	CHIP RES.	150k	1/16W	5%	RMC1/16 154JATP	J24185154		1-	A	H4
R 3173	CHIP RES.	150k	1/16W	5%	RMC1/16 154JATP	J24185154		1-	A	I4
R 3174	CHIP RES.	33k	1/16W	5%	RMC1/16 333JATP	J24185333		1-	A	E2
R 3175	CHIP RES.	470	1/16W	5%	RMC1/16 471JATP	J24185471		1-	A	H4
R 3176	CHIP RES.	1k	1/16W	5%	RMC1/16 102JATP	J24185102		1-	A	J2
R 3177	CHIP RES.	100	1/16W	5%	RMC1/16 101JATP	J24185101		1-	A	H4
R 3178	CHIP RES.	68k	1/16W	5%	RMC1/16 683JATP	J24185683		1-	A	I4
R 3180	CHIP RES.	33k	1/16W	5%	RMC1/16 333JATP	J24185333		1-	A	H1
R 3181	CHIP RES.	10k	1/16W	5%	RMC1/16 103JATP	J24185103		1-	A	F1
R 3182	CHIP RES.	22	1/16W	5%	RMC1/16 220JATP	J24185220		1-	A	H1
R 3183	CHIP RES.	330	1/10W	5%	RMC1/10T 331J	J24205331		1-	A	G2
R 3184	CHIP RES.	10k	1/16W	5%	RMC1/16 103JATP	J24185103		1-	A	I4

RX-1Unit

Parts List

REF	DESCRIPTION	VALUE	V/W	TOL.	MFR'S DESIG	VXSTD P/N	VERS.	LOT	SIDE	LAY ADR
R 3185	CHIP RES.	10k	1/16W	5%	RMC1/16 103JATP	J24185103		1-	A	H4
R 3186	CHIP RES.	10k	1/16W	5%	RMC1/16 103JATP	J24185103		1-	A	H1
R 3187	CHIP RES.	10k	1/16W	5%	RMC1/16 103JATP	J24185103		1-	A	G1
R 3188	CHIP RES.	10	1/16W	5%	RMC1/16 100JATP	J24185100		1-	A	F2
R 3189	CHIP RES.	220	1/16W	5%	RMC1/16 221JATP	J24185221		1-	A	H1
R 3190	CHIP RES.	100	1/16W	5%	RMC1/16 101JATP	J24185101		1-	A	J1
R 3191	CHIP RES.	0	1/16W	5%	RMC1/16 000JATP	J24185000		1-	A	J1
R 3192	CHIP RES.	68k	1/16W	5%	RMC1/16 683JATP	J24185683		1-	A	I4
R 3193	CHIP RES.	100	1/16W	5%	RMC1/16 101JATP	J24185101		1-	A	H4
R 3194	CHIP RES.	68	1/10W	5%	RMC1/10T 680J	J24205680		1-	A	G4
R 3195	CHIP RES.	330	1/16W	5%	RMC1/16 331JATP	J24185331		1-	A	E2
R 3196	CHIP RES.	68k	1/16W	5%	RMC1/16 683JATP	J24185683		1-	A	J1
R 3197	CHIP RES.	75k	1/16W	1%	RMC1/16 753FTP	J24183753		1-	A	G1
R 3198	CHIP RES.	150k	1/16W	5%	RMC1/16 154JATP	J24185154		1-	A	I4
R 3199	CHIP RES.	18	1/16W	5%	RMC1/16 180JATP	J24185180		1-	A	E2
R 3200	CHIP RES.	150k	1/16W	5%	RMC1/16 154JATP	J24185154		1-	A	H4
R 3201	CHIP RES.	10k	1/16W	5%	RMC1/16 103JATP	J24185103		1-	A	I4
R 3202	CHIP RES.	10k	1/16W	5%	RMC1/16 103JATP	J24185103		1-	A	J4
R 3203	CHIP RES.	100k	1/16W	5%	RMC1/16 104JATP	J24185104		1-	A	H4
R 3204	CHIP RES.	330	1/16W	5%	RMC1/16 331JATP	J24185331		1-	A	E2
R 3205	CHIP RES.	470	1/16W	5%	RMC1/16 471JATP	J24185471		1-	A	F2
R 3206	CHIP RES.	1k	1/16W	5%	RMC1/16 102JATP	J24185102		1-	A	J4
R 3207	CHIP RES.	33	1/16W	5%	RMC1/16 330JATP	J24185330		1-	A	G4
R 3208	CHIP RES.	33k	1/16W	1%	RMC1/16 333FTP	J24183333		1-	A	G2
R 3209	CHIP RES.	330	1/16W	5%	RMC1/16 331JATP	J24185331		1-	A	G3
R 3210	CHIP RES.	100k	1/16W	5%	RMC1/16 104JATP	J24185104		1-	A	H4
R 3211	CHIP RES.	100k	1/16W	5%	RMC1/16 104JATP	J24185104		1-4	A	H2
R 3212	CHIP RES.	100k	1/16W	5%	RMC1/16 104JATP	J24185104		1-4	A	G2
R 3213	CHIP RES.	100k	1/16W	5%	RMC1/16 104JATP	J24185104		1-4	A	G2
R 3214	CHIP RES.	100k	1/16W	5%	RMC1/16 104JATP	J24185104		1-4	A	J2
R 3215	CHIP RES.	470	1/16W	5%	RMC1/16 471JATP	J24185471		1-	A	F2
R 3216	CHIP RES.	1k	1/16W	5%	RMC1/16 102JATP	J24185102		1-	A	G4
R 3217	CHIP RES.	22k	1/16W	5%	RMC1/16 223JATP	J24185223		1-	A	J4
R 3218	CHIP RES.	100k	1/16W	5%	RMC1/16 104JATP	J24185104		1-4	A	I2
R 3219	CHIP RES.	47	1/16W	5%	RMC1/16 470JATP	J24185470		1-	A	J4
R 3220	CHIP RES.	4.7k	1/16W	5%	RMC1/16 472JATP	J24185472		1-	A	J4
R 3221	CHIP RES.	100	1/16W	5%	RMC1/16 101JATP	J24185101		1-	A	H4
R 3222	CHIP RES.	6.8k	1/16W	1%	RMC1/16 682FTP	J24183682		1-	A	G1
R 3223	CHIP RES.	470	1/16W	5%	RMC1/16 471JATP	J24185471		1-	A	F2
R 3224	CHIP RES.	10k	1/16W	5%	RMC1/16 103JATP	J24185103		1-	A	G2
R 3225	CHIP RES.	10k	1/16W	5%	RMC1/16 103JATP	J24185103		1-	A	I4
R 3226	CHIP RES.	330	1/10W	5%	RMC1/10T 331J	J24205331		1-	A	G2
R 3227	CHIP RES.	330	1/10W	5%	RMC1/10T 331J	J24205331		1-	A	G2
R 3228	CHIP RES.	3.3k	1/16W	1%	RMC1/16 332FTP	J24183332		1-	A	G1
R 3229	CHIP RES.	10	1/10W	5%	RMC1/10T 100J	J24205100		1-	A	G4
R 3230	CHIP RES.	6.8k	1/16W	1%	RMC1/16 682FTP	J24183682		1-	A	G1
R 3231	CHIP RES.	33	1/10W	5%	RMC1/10T 330J	J24205330		1-	A	G4
R 3233	CHIP RES.	33k	1/16W	5%	RMC1/16 333JATP	J24185333		1-	A	G1
R 3234	CHIP RES.	100	1/16W	5%	RMC1/16 101JATP	J24185101		1-	A	I4
R 3235	CHIP RES.	3.3	1/16W	5%	RMC1/16 3R3JATP	J24185339		1-	A	G4
R 3236	CHIP RES.	330	1/10W	5%	RMC1/10T 331J	J24205331		1-	A	J2
R 3237	CHIP RES.	3.3	1/16W	5%	RMC1/16 3R3JATP	J24185339		1-	A	G3
R 3238	CHIP RES.	390	1/16W	5%	RMC1/16 391JATP	J24185391		1-	A	G3
R 3239	CHIP RES.	470	1/16W	5%	RMC1/16 471JATP	J24185471		1-	A	G3
R 3240	CHIP RES.	330	1/10W	5%	RMC1/10T 331J	J24205331		1-	A	I2
R 3241	CHIP RES.	330	1/10W	5%	RMC1/10T 331J	J24205331		1-	A	H2
R 3242	CHIP RES.	6.8k	1/16W	1%	RMC1/16 682FTP	J24183682		1-	A	G1
R 3243	CHIP RES.	68k	1/16W	5%	RMC1/16 683JATP	J24185683		1-	A	I4
R 3244	CHIP RES.	10k	1/16W	5%	RMC1/16 103JATP	J24185103		1-	A	G1
R 3245	CHIP RES.	100k	1/16W	5%	RMC1/16 104JATP	J24185104		1-	A	I4
R 3246	CHIP RES.	47k	1/16W	5%	RMC1/16 473JATP	J24185473		1-	A	J4
R 3247	CHIP RES.	22k	1/16W	5%	RMC1/16 223JATP	J24185223		1-	A	J4
R 3248	CHIP RES.	100k	1/16W	5%	RMC1/16 104JATP	J24185104		1-	A	G1
R 3249	CHIP RES.	33k	1/16W	5%	RMC1/16 333JATP	J24185333		1-	A	G1
R 3250	CHIP RES.	1k	1/16W	5%	RMC1/16 102JATP	J24185102		1-	A	I4
R 3251	CHIP RES.	47k	1/16W	5%	RMC1/16 473JATP	J24185473		1-	A	J4
R 3252	CHIP RES.	100	1/16W	5%	RMC1/16 101JATP	J24185101		1-	A	G4
R 3253	CHIP RES.	18k	1/16W	5%	RMC1/16 183JATP	J24185183		1-	A	G3
R 3254	CHIP RES.	18k	1/16W	5%	RMC1/16 183JATP	J24185183		1-	A	G3
R 3255	CHIP RES.	68k	1/16W	5%	RMC1/16 683JATP	J24185683		1-	A	J4
R 3256	CHIP RES.	100k	1/16W	5%	RMC1/16 104JATP	J24185104		1-	A	G4
R 3257	CHIP RES.	1.8k	1/16W	5%	RMC1/16 182JATP	J24185182		1-	A	G3
R 3258	CHIP RES.	1.5k	1/16W	5%	RMC1/16 152JATP	J24185152		1-	A	G3

RX-1 Unit

Parts List

REF	DESCRIPTION	VALUE	V/W	TOL.	MFR'S DESIG	VXSTD P/N	VERS.	LOT	SIDE	LAY ADR
R 3259	CHIP RES.	3.3k	1/16W	1%	RMC1/16 332FTP	J24183332		1-	A	G1
R 3260	CHIP RES.	2.2k	1/16W	5%	RMC1/16 222JATP	J24185222		1-	A	G3
R 3262	CHIP RES.	100	1/16W	5%	RMC1/16 101JATP	J24185101		1-	A	I4
R 3263	CHIP RES.	18k	1/16W	5%	RMC1/16 183JATP	J24185183		1-	A	G3
R 3264	CHIP RES.	18k	1/16W	5%	RMC1/16 183JATP	J24185183		1-	A	G3
R 3265	CHIP RES.	1k	1/16W	5%	RMC1/16 102JATP	J24185102		1-	A	J4
R 3266	CHIP RES.	120	1/16W	5%	RMC1/16 121JATP	J24185121		1-	A	H4
R 3267	CHIP RES.	3.9k	1/16W	5%	RMC1/16 392JATP	J24185392		1-	A	H4
R 3268	CHIP RES.	180	1/16W	5%	RMC1/16 181JATP	J24185181		1-	A	I4
R 3269	CHIP RES.	2.7k	1/16W	5%	RMC1/16 272JATP	J24185272		1-	A	I4
R 3270	CHIP RES.	0	1/16W	5%	RMC1/16 000JATP	J24185000		1-	A	I4
R 3272	CHIP RES.	4.7k	1/16W	5%	RMC1/16 472JATP	J24185472		1-	A	J4
R 3273	CHIP RES.	3.9k	1/16W	5%	RMC1/16 392JATP	J24185392		1-	A	H4
R 3274	CHIP RES.	2.7k	1/16W	5%	RMC1/16 272JATP	J24185272		1-	A	H4
R 3276	CHIP RES.	22k	1/16W	5%	RMC1/16 223JATP	J24185223		1-	A	G4
R 3277	CHIP RES.	100	1/16W	5%	RMC1/16 101JATP	J24185101		1-	A	G1
R 3277	CHIP RES.	2.2k	1/16W	5%	RMC1/16 222JATP	J24185222		5-	A	G1
R 3278	CHIP RES.	2.2k	1/16W	5%	RMC1/16 222JATP	J24185222		1-	A	G1
R 3279	CHIP RES.	47	1/16W	5%	RMC1/16 470JATP	J24185470		1-	A	F2
R 3280	CHIP RES.	22k	1/16W	5%	RMC1/16 223JATP	J24185223		1-	A	G1
R 3281	CHIP RES.	330	1/10W	5%	RMC1/10T 331J	J24205331		1-	A	G4
R 3282	CHIP RES.	330	1/10W	5%	RMC1/10T 331J	J24205331		1-	A	G3
R 3283	CHIP RES.	330	1/10W	5%	RMC1/10T 331J	J24205331		1-	A	G3
R 3284	CHIP RES.	4.7k	1/16W	5%	RMC1/16 472JATP	J24185472		1-	A	G4
R 3285	CHIP RES.	10k	1/16W	5%	RMC1/16 103JATP	J24185103		1-	A	F2
R 3286	CHIP RES.	330	1/10W	5%	RMC1/10T 331J	J24205331		1-	A	H4
R 3287	CHIP RES.	330	1/10W	5%	RMC1/10T 331J	J24205331		1-	A	I4
R 3288	CHIP RES.	330	1/10W	5%	RMC1/10T 331J	J24205331		1-	A	J4
R 3289	CHIP RES.	22k	1/16W	5%	RMC1/16 223JATP	J24185223		1-	A	G1
R 3290	CHIP RES.	15k	1/16W	5%	RMC1/16 153JATP	J24185153		1-	A	I4
R 3291	CHIP RES.	1k	1/16W	5%	RMC1/16 102JATP	J24185102		1-	A	J4
R 3292	CHIP RES.	22k	1/16W	5%	RMC1/16 223JATP	J24185223		1-	A	J4
R 3293	CHIP RES.	100k	1/16W	5%	RMC1/16 104JATP	J24185104		1-	A	F2
R 3294	CHIP RES.	6.8k	1/16W	5%	RMC1/16 682JATP	J24185682		1-	A	F2
R 3295	CHIP RES.	100k	1/16W	5%	RMC1/16 104JATP	J24185104		1-	A	F2
R 3296	CHIP RES.	1k	1/16W	5%	RMC1/16 102JATP	J24185102		1-	A	G1
R 3297	CHIP RES.	0	1/16W	5%	RMC1/16 000JATP	J24185000		1-	A	E1
R 3298	CHIP RES.	100k	1/16W	5%	RMC1/16 104JATP	J24185104		1-	A	J1
R 3299	CHIP RES.	10k	1/16W	1%	RMC1/16 103FTP	J24183103		1-	A	J1
R 3300	CHIP RES.	10k	1/16W	1%	RMC1/16 103FTP	J24183103		1-	A	J1
R 3301	CHIP RES.	10	1/16W	5%	RMC1/16 100JATP	J24185100		1-	A	I1
R 3302	CHIP RES.	12k	1/16W	1%	RMC1/16 123FTP	J24183123		1-	A	J1
R 3303	CHIP RES.	4.7k	1/16W	1%	RMC1/16 472FTP	J24183472		1-	A	J1
R 3306	CHIP RES.	10k	1/16W	5%	RMC1/16 103JATP	J24185103		1-	A	I1
R 3307	CHIP RES.	1k	1/16W	5%	RMC1/16 102JATP	J24185102		1-	A	G1
R 3308	CHIP RES.	100	1/16W	5%	RMC1/16 101JATP	J24185101		1-	A	F4
R 3309	CHIP RES.	68	1/10W	5%	RMC1/10T 680J	J24205680		1-	A	A4
R 3310	CHIP RES.	1k	1/16W	5%	RMC1/16 102JATP	J24185102		1-	A	A4
R 3311	CHIP RES.	22	1/16W	5%	RMC1/16 220JATP	J24185220		1-	A	A3
R 3312	CHIP RES.	1k	1/16W	5%	RMC1/16 102JATP	J24185102		1-	A	I2
R 3313	CHIP RES.	0	1/16W	5%	RMC1/16 000JATP	J24185000		1-	A	F4
R 3314	CHIP RES.	0	1/16W	5%	RMC1/16 000JATP	J24185000		1-	A	A4
R 3315	CARBON FILM RES.	10	1/6W	5%	RD16PJ100 10	J01225100		1-	A	E4
R 3315	CHIP RES.	10	1/16W	5%	RMC1/16 100JATP	J24185100		4-	A	E4
R 3315	CHIP RES.	33	1/16W	5%	RMC1/16 330JATP	J24185330		14-	A	E4
R 3316	CHIP RES.	0	1/16W	5%	RMC1/16 000JATP	J24185000	W/ CE LABEL	8-	A	G1
R 3316	CHIP RES.	0	1/16W	5%	RMC1/16 000JATP	J24185000	W/O CE LABEL	11-	A	G1
R 3317	CHIP RES.	3.3k	1/16W	5%	RMC1/16 332JATP	J24185332		5-	A	
RL3001	RELAY		DC12V		FTR-B3GA012Z-B10 DC12V	M1190201		1-	A	A1
RL3002	RELAY		DC12V		FTR-B3GA012Z-B10 DC12V	M1190201		1-	A	A2
RL3003	RELAY		DC12V		FTR-B3GA012Z-B10 DC12V	M1190201		1-	A	A2
RL3004	RELAY		DC12V		FTR-B3GA012Z-B10 DC12V	M1190201		1-	A	A2
RL3005	RELAY		DC12V		FTR-B3GA012Z-B10 DC12V	M1190201		1-	A	A3
RL3006	RELAY		DC12V		FTR-B3GA012Z-B10 DC12V	M1190201		1-	A	B3
RL3007	RELAY		DC12V		FTR-B3GA012Z-B10 DC12V	M1190201		1-	A	B2
RL3008	RELAY		DC12V		FTR-B3GA012Z-B10 DC12V	M1190201		1-	A	B3
RL3009	RELAY		DC12V		FTR-B3GA012Z-B10 DC12V	M1190201		1-	A	B3
RL3010	RELAY		DC12V		FTR-B3GA012Z-B10 DC12V	M1190201		1-	A	B2
RL3011	RELAY		DC12V		FTR-B3GA012Z-B10 DC12V	M1190201		1-	A	B2
RL3012	RELAY		DC12V		FTR-B3GA012Z-B10 DC12V	M1190201		1-	A	B1
RL3013	RELAY		DC12V		FTR-B3GA012Z-B10 DC12V	M1190201		1-	A	B3
RL3014	RELAY		DC12V		FTR-B3GA012Z-B10 DC12V	M1190201		1-	A	B4
RL3015	RELAY		DC12V		FTR-B3GA012Z-B10 DC12V	M1190201		1-	A	B3

RX-1Unit

Parts List

REF	DESCRIPTION	VALUE	V/W	TOL.	MFR'S DESIG	VXSTD P/N	VERS.	LOT	SIDE	LAY ADR
RL3016	RELAY		DC12V		FTR-B3GA012Z-B10 DC12V	M1190201		1-	A	D3
RL3017	RELAY		DC12V		FTR-B3GA012Z-B10 DC12V	M1190201		1-	A	D3
RL3018	RELAY		DC12V		FTR-B3GA012Z-B10 DC12V	M1190201		1-	A	D4
RL3019	RELAY		DC12V		FTR-B3GA012Z-B10 DC12V	M1190201		1-	A	E4
RL3020	RELAY		DC12V		FTR-B3GA012Z-B10 DC12V	M1190201		1-	A	F4
T 3001	COIL WIDE-TRANS.				050812564 92H5	L0022619		1-	A	E4
T 3002	COIL WIDE-TRANS.				3A4RIB8/14/13	L0023052		1-	A	E4
T 3003	COIL 07RF	160MHz			160M R12-K905X	L0022053		1-	A	D2
T 3004	BALUN TRANSFOMERS				070812736D	L0023047		1-	A	E3
T 3004	BALUN TRANSFOMERS				100812913A	L0023088		20-	A	E3
T 3005	COIL 10RF	0.19uH			0.19U	L0022999A		1-	A	E3
T 3006	BALUN TRANSFOMERS				070812736D	L0023047		1-	A	E3
T 3007	BALUN TRANSFOMERS				070812735D	L0023046		1-	A	E3
T 3008	BALUN TRANSFOMERS				070812735D	L0023046		1-	A	E4
T 3009	BALUN TRANSFOMERS				070812735D	L0023046		1-	A	E2
T 3010	BALUN TRANSFOMERS				070812737B	L0023048		1-	A	E2
T 3011	BALUN TRANSFOMERS				070812735D	L0023046		1-	A	G1
T 3012	BALUN TRANSFOMERS				070812735D	L0023046		1-	A	F3
T 3013	BALUN TRANSFOMERS				070812735D	L0023046		1-	A	H1
T 3014	BALUN TRANSFOMERS				070812735D	L0023046		1-	A	F4
T 3015	BALUN TRANSFOMERS				070812736D	L0023047		1-	A	F3
T 3016	BALUN TRANSFOMERS				#458PT-1586	L0190276		1-	A	E2
T 3017	BALUN TRANSFOMERS				080812770	L0023050		1-	A	F4
T 3018	COIL 07RF	9MHz			070812754D 9.0M	L0023053		1-	A	H1
T 3019	COIL 07RF	9MHz			070812754D 9.0M	L0023053		1-	A	H4
T 3020	COIL 07RF	9MHz			070812754D 9.0M	L0023053		1-	A	H1
T 3021	COIL 07RF	9MHz			070812754D 9.0M	L0023053		1-	A	I1
T 3022	BALUN TRANSFOMERS				080812770	L0023050		1-	A	G4
T 3023	COIL 07RF	9MHz			070812754D 9.0M	L0023053		1-	A	H4
T 3024	COIL WIDE-TRANS.				050812564 92H5	L0022619		1-	A	G4
T 3025	COIL 07RF	9MHz			070812754D 9.0M	L0023053		1-	A	J1
T 3026	COIL 07RF	9MHz			070812754D 9.0M	L0023053		1-	A	G2
T 3027	COIL 07RF	9MHz			070812754D 9.0M	L0023053		1-	A	G2
T 3028	COIL 07RF	9MHz			070812754D 9.0M	L0023053		1-	A	I4
T 3029	BALUN TRANSFOMERS				070812737B	L0023048		1-	A	G3
T 3030	BALUN TRANSFOMERS				080812769	L0023049		1-	A	G4
T 3031	COIL 07RF	9MHz			070812754D 9.0M	L0023053		1-	A	G3
T 3032	COIL 07RF	9MHz			070812754D 9.0M	L0023053		1-	A	G3
T 3033	BALUN TRANSFOMERS				070812736D	L0023047		1-	A	F4
T 3034	COIL 07RF	9MHz			070812754D 9.0M	L0023053		1-	A	A3
TP3016	CHECK TERMINAL				RCT00000C	Q5000103		1-	A	E2
TP3020	CHECK TERMINAL				RCT00000C	Q5000103		1-	A	G4
TP3023	CHECK TERMINAL				RCT00000C	Q5000103		1-	A	H1
TP3026	CHECK TERMINAL				RCT00000C	Q5000103		1-	A	J2
XF3001	XTAL FILTER				MF9QB 9.000MHZ	H1102451		1-	A	F4
XF3002	XTAL FILTER				MF9QB 9.000MHZ	H1102451		1-	A	G4
XF3003	XTAL FILTER				MF9QB 9.000MHZ	H1102451		1-	A	G3
XF3004	XTAL FILTER				MF9QB 9.000MHZ	H1102451		1-	A	G2
XF3005	XTAL FILTER				MF9MB 9.000MHZ	H1102452		1-	A	G3
XF3006	XTAL FILTER				MF9MB 9.000MHZ	H1102452		1-	A	G2
XF3007	XTAL FILTER				MF9RB 9.000MHZ	H1102460		1-	A	I1
XF3008	XTAL FILTER				MF9RB 9.000MHZ	H1102460		1-	A	I1
XF3009	XTAL FILTER				X09F03A 9.000MHZ	H1102453	W/FILTER	1-	A	I3
XF3010	XTAL FILTER				X09F30A 9.000MHZ	H1102455		1-	A	H3
XF3011	XTAL FILTER				X09F06B 9.000MHZ	H1102454		1-	A	I3
	SHIELD CASE					RA0659300		1-		
	SHIELD CASE COVER				(37x30.5)	RA1152400		1-		
	COVER				(P1090633)	RA1266500	W/CE LABEL	8-		

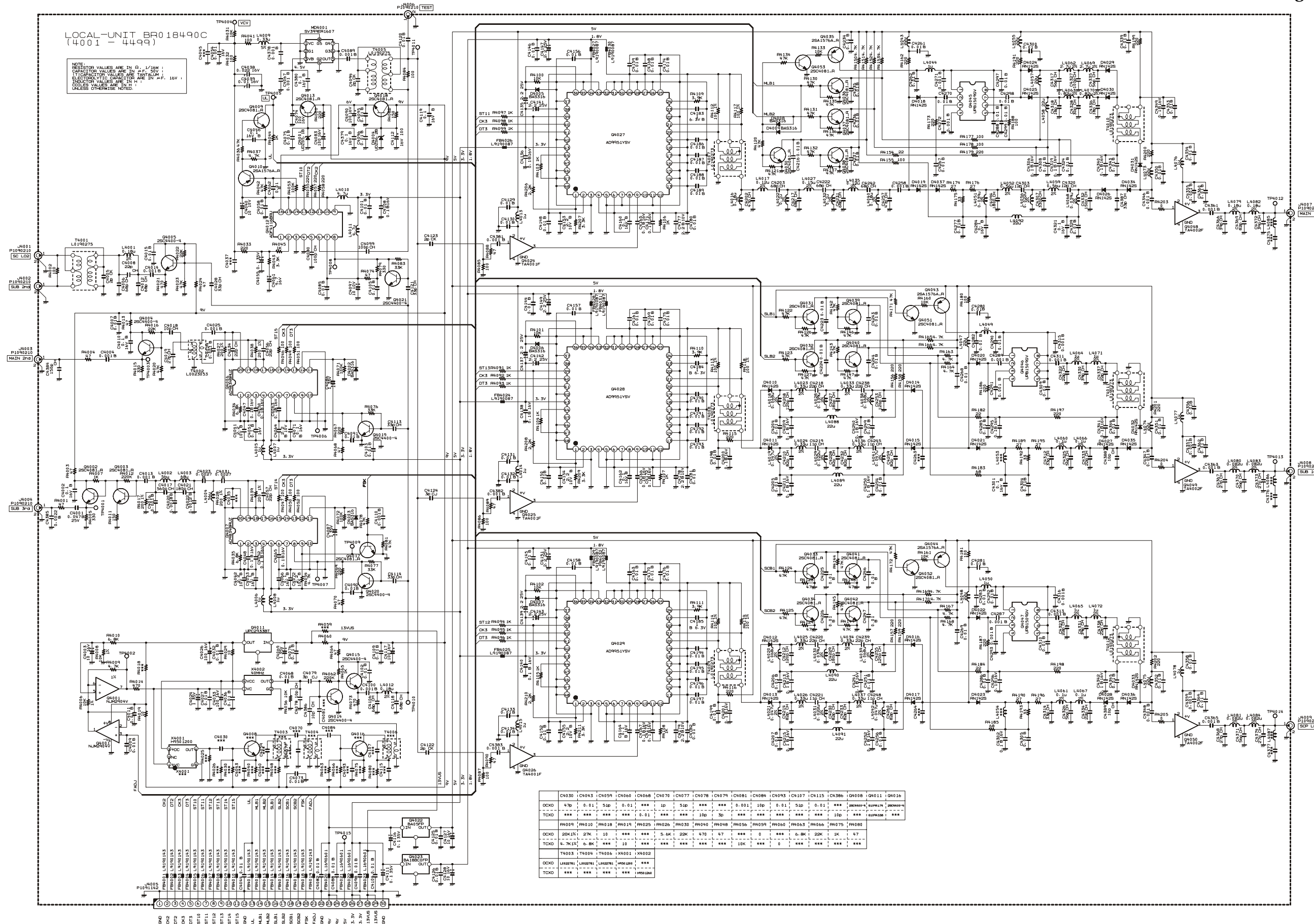

LOCAL Unit

Note

LOCAL Unit

Parts Layout (Side A)

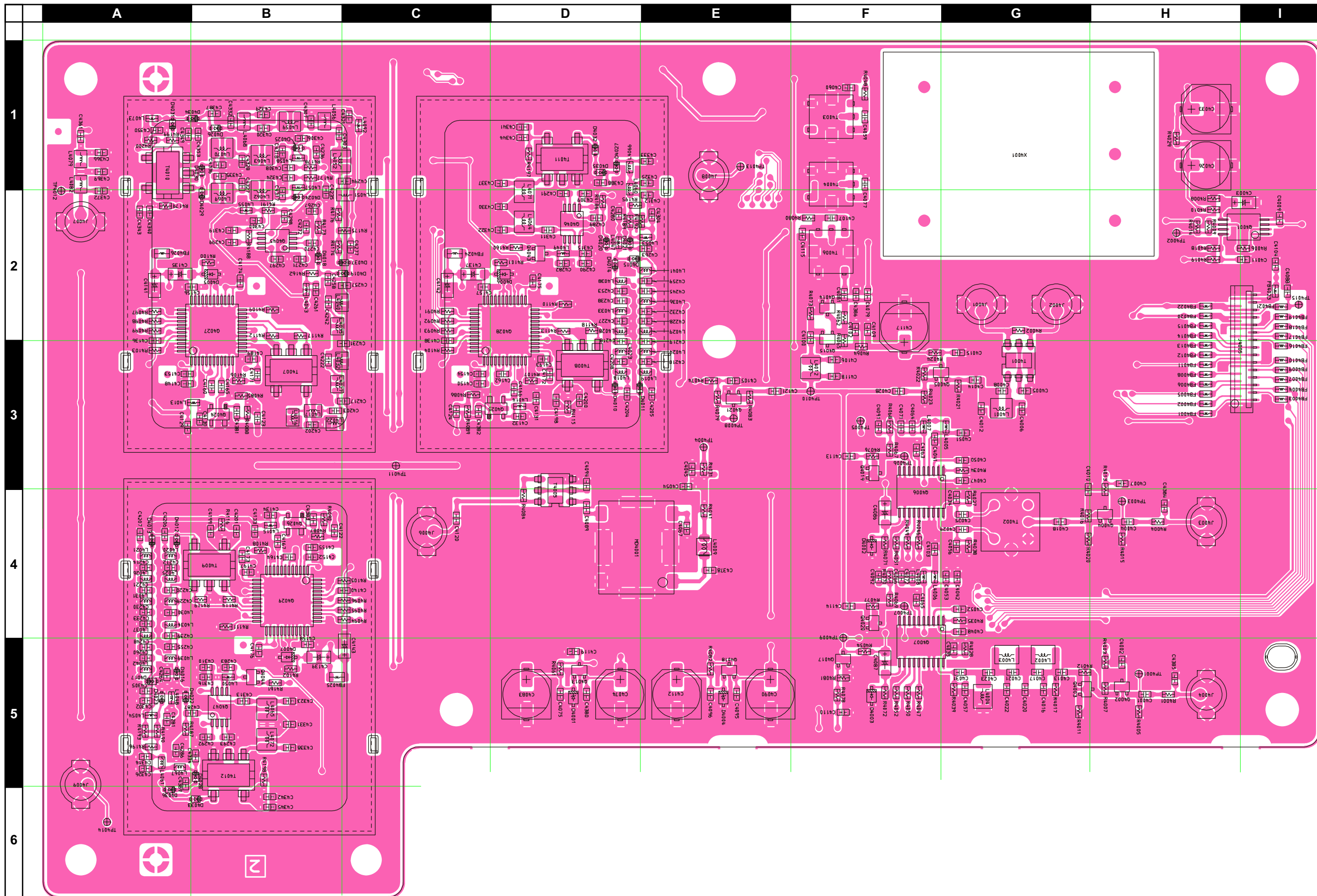

LOCAL Unit

Parts Layout (Side B)

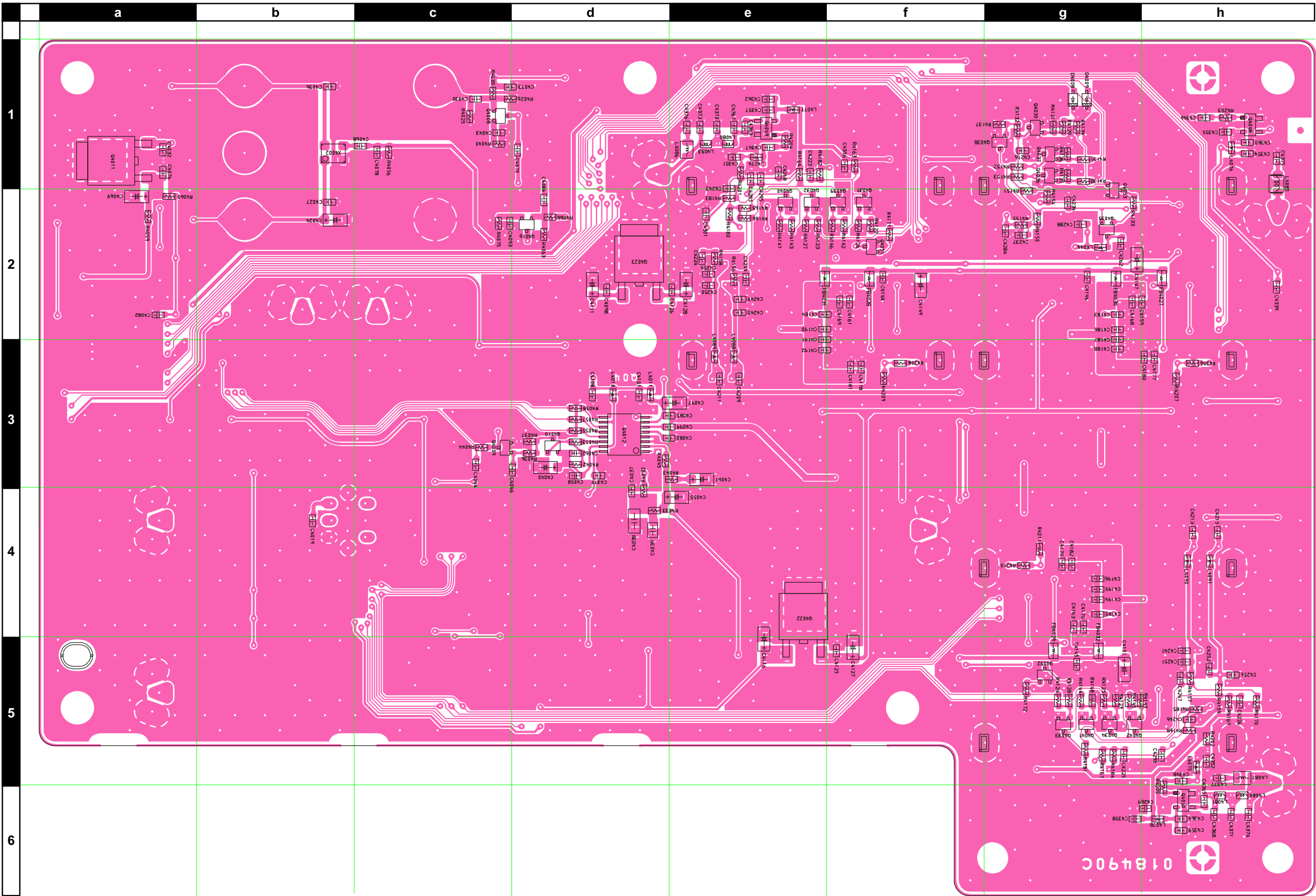

LOCAL Unit

Parts List

REF	DESCRIPTION	VALUE	V/W	TOL.	MFR'S DESIG	VXSTD P/N	VERS.	LOT	SIDE	LAY ADR
PCB with Components						CS2074701 CS2074702	TCXO OCXO			
	Printed Circuit Board					FR018490C				
C 4001	CHIP CAP.	0.047uF	25V	B	GRM188B11E473KA01D	K22144811		1-	A	B2
C 4002	CHIP CAP.	0.1uF	16V	B	GRM188B11C104KA01D	K22124805		1-	A	B2
C 4003	CHIP TA.CAP.	10uF	16V		TEESVA1C106M8R	K78120077		1-	A	A5
C 4004	CHIP CAP.	0.001uF	50V	B	GRM188B11H102KA01D	K22174821		1-	A	B3
C 4005	CHIP CAP.	2pF	50V	CK	GRM1884C1H2R0CZ01D	K22174203		1-	A	B4
C 4006	CHIP CAP.	68pF	50V	CH	GRM1882C1H680JA01D	K22174231		1-	A	B4
C 4007	CHIP CAP.	0.01uF	50V	B	GRM188B11H103KA01D	K22174823		1-	A	B3
C 4008	CHIP CAP.	22pF	50V	CH	GRM1882C1H220JA01D	K22174219		1-	A	C4
C 4009	CHIP CAP.	0.01uF	50V	B	GRM188B11H103KA01D	K22174823		1-	A	A5
C 4010	CHIP CAP.	0.1uF	16V	B	GRM188B11C104KA01D	K22124805		1-	A	B3
C 4011	CHIP CAP.	0.01uF	50V	B	GRM188B11H103KA01D	K22174823		1-	A	A5
C 4012	CHIP CAP.	68pF	50V	CH	GRM1882C1H680JA01D	K22174231		1-	A	C4
C 4013	CHIP CAP.	0.001uF	50V	B	GRM188B11H102KA01D	K22174821		1-	A	B2
C 4014	CHIP CAP.	0.001uF	50V	B	GRM188B11H102KA01D	K22174821		1-	A	C4
C 4015	CHIP CAP.	0.01uF	50V	B	GRM188B11H103KA01D	K22174823		1-	A	C4
C 4016	CHIP CAP.	0.001uF	50V	B	GRM188B11H102KA01D	K22174821		1-	A	B2
C 4017	CHIP CAP.	560pF	50V	CH	GRM1882C1H561JA01D	K22174273		1-	A	B2
C 4018	CHIP CAP.	10pF	50V	CH	GRM1882C1H100JA01D	K22174211		1-	A	B3
C 4019	CHIP CAP.	27pF	50V	CH	GRM1882C1H270JA01D	K22174221		1-	B	g3
C 4020	CHIP CAP.	0.0018uF	50V	B	GRM188B11H182KA01D	K22174828		1-	A	B2
C 4021	CHIP CAP.	180pF	50V	CH	GRM1882C1H181JA01D	K22174241		1-	A	C2
C 4022	CHIP CAP.	0.0012uF	50V	B	GRM188B11H122KA01D	K22174826		1-	A	C2
C 4023	CHIP CAP.	0.0027uF	50V	B	GRM188B11H272KA01D	K22174829		1-	A	C2
C 4024	CHIP TA.CAP.	1uF	35V		TEESVA1V105M8R	K78160032		1-	B	g5
C 4025	CHIP CAP.	0.001uF	50V	B	GRM188B11H102KA01D	K22174821		1-	A	C3
C 4026	AL.ELECTRO.CAP.	100uF	16V		EEE1CA101WP	K48120012		1-	A	A5
C 4027	CHIP CAP.	0.01uF	50V	B	GRM188B11H103KA01D	K22174823		1-	B	g5
C 4028	CHIP CAP.	33pF	50V	CH	GRM1882C1H330JA01D	K22174223		1-	A	C4
C 4029	CHIP CAP.	0.001uF	50V	B	GRM188B11H102KA01D	K22174821		1-	A	C3
C 4030	CHIP CAP.	47pF	50V	CH	GRM1882C1H470JA01D	K22174227	W/OCXO	1-	B	f6
C 4031	CHIP CAP.	0.0027uF	50V	B	GRM188B11H272KA01D	K22174829		1-	A	C2
C 4032	CHIP CAP.	0.01uF	50V	B	GRM188B11H103KA01D	K22174823		1-	B	h5
C 4033	AL.ELECTRO.CAP.	100uF	16V		EEE1CA101WP	K48120012		1-	A	A6
C 4034	CHIP CAP.	22pF	50V	CH	GRM1882C1H220JA01D	K22174219		1-	A	C3
C 4036	CHIP CAP.	0.01uF	50V	B	GRM188B11H103KA01D	K22174823		1-	B	g6
C 4038	FILM CAP.	0.022uF	16V		ECHU1C223JX5	K57120034		1-	B	e3
C 4039	FILM CAP.	0.01uF	16V		ECHU1C103JX5	K57120030		1-	B	e3
C 4040	CHIP TA.CAP.	10uF	10V		TEESVA1A106M8R	K78100028		1-	B	f3
C 4041	CHIP CAP.	2.2uF	10V	B	GRM188B31A225KE18D	K22104805		1-	A	C4
C 4042	CHIP CAP.	2.2uF	10V	B	GRM188B31A225KE18D	K22104805		1-	A	C3
C 4043	CHIP CAP.	0.01uF	50V	B	GRM188B11H103KA01D	K22174823	W/OCXO	1-	B	f6
C 4044	CHIP CAP.	0.01uF	50V	B	GRM188B11H103KA01D	K22174823		1-	B	f3
C 4046	CHIP CAP.	0.1uF	16V	B	GRM188B11C104KA01D	K22124805		1-	B	f3
C 4047	CHIP CAP.	0.1uF	16V	B	GRM188B11C104KA01D	K22124805		1-	A	C3
C 4048	CHIP CAP.	0.1uF	16V	B	GRM188B11C104KA01D	K22124805		1-	A	C2
C 4050	CHIP CAP.	0.1uF	16V	B	GRM188B11C104KA01D	K22124805		1-	A	C3
C 4051	CHIP CAP.	0.1uF	16V	B	GRM188B11C104KA01D	K22124805		1-	A	C4
C 4052	CHIP CAP.	0.1uF	16V	B	GRM188B11C104KA01D	K22124805		1-	A	C2
C 4053	CHIP CAP.	0.1uF	16V	B	GRM188B11C104KA01D	K22124805		1-	A	C3
C 4054	FILM CAP.	0.001uF	16V		ECHU1C102JX5	K57120042		1-	A	E3
C 4055	CHIP TA.CAP.	0.1uF	35V		TEESVA1V104M8R	K78160025		1-	B	e3
C 4056	CHIP CAP.	22pF	50V	CH	GRM1882C1H220JA01D	K22174219		1-	A	C2
C 4057	CHIP CAP.	22pF	50V	CH	GRM1882C1H220JA01D	K22174219		1-	A	C3
C 4058	CHIP CAP.	0.01uF	50V	B	GRM188B11H103KA01D	K22174823		1-	B	e3
C 4059	CHIP CAP.	51pF	50V	CH	GRM1882C1H510JZ01D	K22174228	W/OCXO	1-	A	D6
C 4060	CHIP CAP.	0.01uF	50V	B	GRM188B11H103KA01D	K22174823	W/OCXO	1-	A	D6
C 4061	CHIP TA.CAP.	4.7uF	16V		TEESVA1C475M8R	K78120031		1-	B	e3
C 4062	CHIP CAP.	0.01uF	50V	B	GRM188B11H103KA01D	K22174823		1-	B	e3
C 4063	CHIP CAP.	0.1uF	16V	B	GRM188B11C104KA01D	K22124805		1-	A	C3
C 4064	CHIP CAP.	2.2uF	10V	B	GRM188B31A225KE18D	K22104805		1-	A	C4
C 4065	CHIP CAP.	0.1uF	16V	B	GRM188B11C104KA01D	K22124805		1-	A	C2
C 4066	CHIP CAP.	0.1uF	16V	B	GRM188B11C104KA01D	K22124805		1-	A	C3
C 4067	CHIP CAP.	0.001uF	50V	B	GRM188B11H102KA01D	K22174821		1-	A	E3
C 4068	CHIP CAP.	0.01uF	50V	B	GRM188B11H103KA01D	K22174823	W/TCXO	1-	B	g5
C 4069	CHIP TA.CAP.	1uF	35V		TEESVA1V105M8R	K78160032		1-	B	h5
C 4070	CHIP CAP.	1pF	50V	CK	GRM1884C1H1R0CZ01D	K22174202	W/OCXO	1-	B	f5
C 4071	CHIP CAP.	0.1uF	16V	B	GRM188B11C104KA01D	K22124805		1-	A	C4
C 4072	CHIP CAP.	2.2uF	10V	B	GRM188B31A225KE18D	K22104805		1-	A	C3
C 4073	CHIP CAP.	0.01uF	50V	B	GRM188B11H103KA01D	K22174823		1-	B	f6
C 4074	AL.ELECTRO.CAP.	100uF	16V		EEE1CA101WP	K48120012		1-	A	E2

LOCAL Unit

Parts List

REF	DESCRIPTION	VALUE	V/W	TOL.	MFR'S DESIG	VXSTD P/N	VERS.	LOT	SIDE	LAY ADR
C 4075	CHIP CAP.	0.01uF	50V	B	GRM188B11H103KA01D	K22174823		1-	A	F2
C 4076	CHIP CAP.	0.01uF	50V	B	GRM188B11H103KA01D	K22174823		1-	B	h5
C 4077	CHIP CAP.	51pF	50V	CH	GRM1882C1H510JZ01D	K22174228	W/OCXO	1-	A	D5
C 4078	CHIP CAP.	10pF	50V	CH	GRM1882C1H100JA01D	K22174211	W/TCXO	1-	B	g5
C 4079	CHIP CAP.	3pF	50V	CJ	GRM1883C1H3R0CZ01D	K22174204	W/TCXO	1-	A	D5
C 4080	CHIP CAP.	100pF	50V	CH	GRM1882C1H101JA01D	K22174235		1-	B	e4
C 4081	CHIP CAP.	0.001uF	50V	B	GRM188B11H102KA01D	K22174821	W/OCXO	1-	A	D5
C 4082	CHIP CAP.	0.01uF	50V	B	GRM188B11H103KA01D	K22174823		1-	B	h4
C 4083	AL.ELECTRO.CAP.	100uF	16V		EEE1CA101WP	K48120012		1-	A	F2
C 4084	CHIP CAP.	10pF	50V	CH	GRM1882C1H100JA01D	K22174211	W/OCXO	1-	B	f5
C 4085	CHIP CAP.	0.01uF	50V	B	GRM188B11H103KA01D	K22174823		1-	B	e4
C 4086	CHIP TA.CAP.	1uF	35V		TEESVA1V105M8R	K78160032		1-	A	C3
C 4087	CHIP TA.CAP.	1uF	35V		TEESVA1V105M8R	K78160032		1-	A	C2
C 4088	CHIP CAP.	0.01uF	50V	B	GRM188B11H103KA01D	K22174823		1-	A	A5
C 4089	CHIP CAP.	0.001uF	50V	B	GRM188B11H102KA01D	K22174821		1-	A	E3
C 4090	AL.ELECTRO.CAP.	100uF	16V		EEE1CA101WP	K48120012		1-	A	D2
C 4091	CHIP CAP.	0.01uF	50V	B	GRM188B11H103KA01D	K22174823		1-	A	C4
C 4092	CHIP CAP.	0.01uF	50V	B	GRM188B11H103KA01D	K22174823		1-	A	C3
C 4093	CHIP CAP.	0.01uF	50V	B	GRM188B11H103KA01D	K22174823	W/OCXO	1-	B	f5
C 4094	CHIP CAP.	2pF	50V	CK	GRM1884C1H2R0CZ01D	K22174203		1-	A	E3
C 4095	CHIP CAP.	0.01uF	50V	B	GRM188B11H103KA01D	K22174823		1-	A	D2
C 4096	CHIP CAP.	0.01uF	50V	B	GRM188B11H103KA01D	K22174823		1-	A	E2
C 4097	CHIP TA.CAP.	10uF	10V		TEESVA1A106M8R	K78100028		1-	B	e4
C 4098	CHIP CAP.	0.01uF	50V	B	GRM188B11H103KA01D	K22174823		1-	B	e5
C 4099	CHIP CAP.	100pF	50V	CH	GRM1882C1H101JA01D	K22174235		1-	B	e4
C 4100	CHIP CAP.	0.001uF	50V	B	GRM188B11H102KA01D	K22174821		1-	A	D4
C 4101	CHIP CAP.	0.01uF	50V	B	GRM188B11H103KA01D	K22174823		1-	B	e4
C 4102	CHIP CAP.	0.01uF	50V	B	GRM188B11H103KA01D	K22174823		1-	A	D4
C 4103	CHIP CAP.	0.01uF	50V	B	GRM188B11H103KA01D	K22174823		1-	A	C3
C 4104	CHIP CAP.	0.01uF	50V	B	GRM188B11H103KA01D	K22174823		1-	A	A5
C 4105	CHIP CAP.	0.01uF	50V	B	GRM188B11H103KA01D	K22174823		1-	A	D4
C 4106	CHIP CAP.	68pF	50V	CH	GRM1882C1H680JA01D	K22174231		1-	A	D4
C 4107	CHIP CAP.	51pF	50V	CH	GRM1882C1H510JZ01D	K22174228	W/OCXO	1-	A	D5
C 4108	CHIP CAP.	0.1uF	16V	B	GRM188B11C104KA01D	K22124805		1-	B	e4
C 4109	CHIP CAP.	0.01uF	50V	B	GRM188B11H103KA01D	K22174823		1-	A	D4
C 4110	CHIP CAP.	0.001uF	50V	B	GRM188B11H102KA01D	K22174821		1-	A	D2
C 4111	CHIP TA.CAP.	0.1uF	35V		TEESVA1V104M8R	K78160025		1-	B	e5
C 4112	AL.ELECTRO.CAP.	100uF	16V		EEE1CA101WP	K48120012		1-	A	E2
C 4113	CHIP CAP.	33pF	50V	CH	GRM1882C1H330JA01D	K22174223		1-	A	D3
C 4114	CHIP CAP.	33pF	50V	CH	GRM1882C1H330JA01D	K22174223		1-	A	D2
C 4115	CHIP CAP.	0.01uF	50V	B	GRM188B11H103KA01D	K22174823	W/OCXO	1-	A	D5
C 4116	CHIP TA.CAP.	0.1uF	35V		TEESVA1V104M8R	K78160025		1-	B	d2
C 4117	AL.ELECTRO.CAP.	100uF	16V		EEE1CA101WP	K48120012		1-	A	C4
C 4118	CHIP CAP.	68pF	50V	CH	GRM1882C1H680JA01D	K22174231		1-	A	D4
C 4119	CHIP CAP.	0.1uF	16V	B	GRM188B11C104KA01D	K22124805		1-	A	E2
C 4120	CHIP CAP.	0.01uF	50V	B	GRM188B11H103KA01D	K22174823		1-	A	F3
C 4121	CHIP CAP.	33pF	50V	CH	GRM1882C1H330JA01D	K22174223		1-	A	D4
C 4122	CHIP CAP.	2pF	50V	CK	GRM1884C1H2R0CZ01D	K22174203		1-	A	G3
C 4123	CHIP CAP.	2pF	50V	CK	GRM1884C1H2R0CZ01D	K22174203		1-	A	H4
C 4124	CHIP CAP.	3pF	50V	CJ	GRM1883C1H3R0CZ01D	K22174204		1-	A	F4
C 4125	CHIP CAP.	0.01uF	50V	B	GRM188B11H103KA01D	K22174823		1-	B	d2
C 4126	CHIP CAP.	0.01uF	50V	B	GRM188B11H103KA01D	K22174823		1-	B	e5
C 4127	CHIP TA.CAP.	10uF	16V		TEESVA1C106M8R	K78120077		1-	B	d2
C 4128	CHIP TA.CAP.	10uF	16V		TEESVA1C106M8R	K78120077		1-	B	e5
C 4129	CHIP CAP.	0.01uF	50V	B	GRM188B11H103KA01D	K22174823		1-	A	H4
C 4130	CHIP CAP.	0.01uF	50V	B	GRM188B11H103KA01D	K22174823		1-	A	H4
C 4131	CHIP CAP.	0.01uF	50V	B	GRM188B11H103KA01D	K22174823		1-	A	F4
C 4132	CHIP CAP.	0.01uF	50V	B	GRM188B11H103KA01D	K22174823		1-	A	F4
C 4133	CHIP CAP.	0.01uF	50V	B	GRM188B11H103KA01D	K22174823		1-	A	H3
C 4134	CHIP CAP.	0.01uF	50V	B	GRM188B11H103KA01D	K22174823		1-	A	G3
C 4135	CHIP TA.CAP.	2.2uF	25V		TEESVA1E225M8R	K78140020		1-	A	H5
C 4136	CHIP CAP.	0.1uF	16V	B	GRM188B11C104KA01D	K22124805		1-	A	H4
C 4137	CHIP TA.CAP.	2.2uF	25V		TEESVA1E225M8R	K78140020		1-	A	F5
C 4138	CHIP CAP.	0.1uF	16V	B	GRM188B11C104KA01D	K22124805		1-	A	F4
C 4139	CHIP TA.CAP.	2.2uF	25V		TEESVA1E225M8R	K78140020		1-	A	G2
C 4140	CHIP CAP.	0.1uF	16V	B	GRM188B11C104KA01D	K22124805		1-	A	G3
C 4141	CHIP TA.CAP.	2.2uF	25V		TEESVA1E225M8R	K78140020		1-	A	H5
C 4142	CHIP TA.CAP.	2.2uF	25V		TEESVA1E225M8R	K78140020		1-	A	F5
C 4143	CHIP TA.CAP.	2.2uF	25V		TEESVA1E225M8R	K78140020		1-	A	G2
C 4144	CHIP CAP.	0.01uF	50V	B	GRM188B11H103KA01D	K22174823		1-	B	c5
C 4145	CHIP CAP.	0.01uF	50V	B	GRM188B11H103KA01D	K22174823		1-	B	b2
C 4146	CHIP CAP.	0.01uF	50V	B	GRM188B11H103KA01D	K22174823		1-	B	b5
C 4147	CHIP TA.CAP.	2.2uF	25V		TEESVA1E225M8R	K78140020		1-	B	b5

LOCAL Unit

Parts List

REF	DESCRIPTION	VALUE	V/W	TOL.	MFR'S DESIG	VXSTD P/N	VERS.	LOT	SIDE	LAY ADR
C 4148	CHIP CAP.	0.01uF	50V	B	GRM188B11H103KA01D	K22174823		1-	A	H4
C 4149	CHIP TA.CAP.	2.2uF	25V		TEESVA1E225M8R	K78140020		1-	B	c5
C 4150	CHIP CAP.	0.01uF	50V	B	GRM188B11H103KA01D	K22174823		1-	A	F4
C 4151	CHIP TA.CAP.	2.2uF	25V		TEESVA1E225M8R	K78140020		1-	B	b2
C 4152	CHIP CAP.	0.01uF	50V	B	GRM188B11H103KA01D	K22174823		1-	A	G3
C 4153	CHIP CAP.	2.2uF	10V	B	GRM188B31A225KE18D	K22104805		1-	A	H4
C 4154	CHIP CAP.	2.2uF	10V	B	GRM188B31A225KE18D	K22104805		1-	A	F4
C 4155	CHIP CAP.	2.2uF	10V	B	GRM188B31A225KE18D	K22104805		1-	A	G3
C 4156	CHIP CAP.	0.01uF	50V	B	GRM188B11H103KA01D	K22174823		1-	A	H5
C 4157	CHIP CAP.	0.01uF	50V	B	GRM188B11H103KA01D	K22174823		1-	A	F5
C 4158	CHIP CAP.	0.01uF	50V	B	GRM188B11H103KA01D	K22174823		1-	A	G2
C 4159	CHIP CAP.	0.01uF	50V	B	GRM188B11H103KA01D	K22174823		1-	B	b4
C 4160	CHIP CAP.	0.1uF	16V	B	GRM188B11C104KA01D	K22124805		1-	A	H4
C 4161	CHIP CAP.	0.01uF	50V	B	GRM188B11H103KA01D	K22174823		1-	B	d4
C 4162	CHIP CAP.	0.1uF	16V	B	GRM188B11C104KA01D	K22124805		1-	A	F4
C 4163	CHIP CAP.	0.01uF	50V	B	GRM188B11H103KA01D	K22174823		1-	B	b2
C 4164	CHIP CAP.	0.1uF	16V	B	GRM188B11C104KA01D	K22124805		1-	A	G3
C 4165	CHIP CAP.	0.1uF	16V	B	GRM188B11C104KA01D	K22124805		1-	A	H4
C 4166	CHIP CAP.	0.1uF	16V	B	GRM188B11C104KA01D	K22124805		1-	A	F4
C 4167	CHIP CAP.	0.1uF	16V	B	GRM188B11C104KA01D	K22124805		1-	A	G3
C 4168	CHIP CAP.	0.01uF	50V	B	GRM188B11H103KA01D	K22174823		1-	B	b4
C 4169	CHIP CAP.	0.01uF	50V	B	GRM188B11H103KA01D	K22174823		1-	B	d4
C 4170	CHIP CAP.	0.01uF	50V	B	GRM188B11H103KA01D	K22174823		1-	B	b2
C 4171	CHIP CAP.	0.1uF	16V	B	GRM188B11C104KA01D	K22124805		1-	A	H4
C 4172	CHIP CAP.	0.1uF	16V	B	GRM188B11C104KA01D	K22124805		1-	A	F4
C 4173	CHIP CAP.	0.1uF	16V	B	GRM188B11C104KA01D	K22124805		1-	A	H3
C 4174	CHIP CAP.	0.01uF	50V	B	GRM188B11H103KA01D	K22174823		1-	A	H5
C 4175	CHIP CAP.	0.01uF	50V	B	GRM188B11H103KA01D	K22174823		1-	A	F5
C 4176	CHIP CAP.	0.01uF	50V	B	GRM188B11H103KA01D	K22174823		1-	A	H2
C 4177	CHIP CAP.	2.2uF	10V	B	GRM188B31A225KE18D	K22104805		1-	B	b4
C 4178	CHIP CAP.	2.2uF	10V	B	GRM188B31A225KE18D	K22104805		1-	B	d4
C 4179	CHIP CAP.	2.2uF	10V	B	GRM188B31A225KE18D	K22104805		1-	B	b3
C 4180	CHIP CAP.	0.01uF	50V	B	GRM188B11H103KA01D	K22174823		1-	B	b4
C 4181	CHIP CAP.	0.01uF	50V	B	GRM188B11H103KA01D	K22174823		1-	B	d4
C 4182	CHIP CAP.	0.01uF	50V	B	GRM188B11H103KA01D	K22174823		1-	B	b3
C 4183	CHIP CAP.	1uF	6.3V	B	GRM188B10J105KA01D	K22084801		1-	B	b4
C 4184	CHIP CAP.	1uF	6.3V	B	GRM188B10J105KA01D	K22084801		1-	B	d4
C 4185	CHIP CAP.	1uF	6.3V	B	GRM188B10J105KA01D	K22084801		1-	B	b2
C 4186	CHIP CAP.	0.01uF	50V	B	GRM188B11H103KA01D	K22174823		1-	B	b4
C 4187	CHIP CAP.	0.01uF	50V	B	GRM188B11H103KA01D	K22174823		1-	B	b4
C 4188	CHIP CAP.	0.01uF	50V	B	GRM188B11H103KA01D	K22174823		1-	B	b4
C 4189	CHIP CAP.	0.01uF	50V	B	GRM188B11H103KA01D	K22174823		1-	A	H4
C 4190	CHIP CAP.	0.01uF	50V	B	GRM188B11H103KA01D	K22174823		1-	B	d4
C 4191	CHIP CAP.	0.01uF	50V	B	GRM188B11H103KA01D	K22174823		1-	B	d4
C 4192	CHIP CAP.	0.01uF	50V	B	GRM188B11H103KA01D	K22174823		1-	B	d4
C 4193	CHIP CAP.	0.01uF	50V	B	GRM188B11H103KA01D	K22174823		1-	A	F4
C 4194	CHIP CAP.	0.01uF	50V	B	GRM188B11H103KA01D	K22174823		1-	B	b2
C 4195	CHIP CAP.	0.01uF	50V	B	GRM188B11H103KA01D	K22174823		1-	B	b3
C 4196	CHIP CAP.	0.01uF	50V	B	GRM188B11H103KA01D	K22174823		1-	B	b3
C 4197	CHIP CAP.	0.01uF	50V	B	GRM188B11H103KA01D	K22174823		1-	A	H3
C 4198	CHIP CAP.	0.01uF	50V	B	GRM188B11H103KA01D	K22174823		1-	A	F4
C 4199	CHIP CAP.	0.01uF	50V	B	GRM188B11H103KA01D	K22174823		1-	A	H3
C 4200	CHIP CAP.	0.1uF	16V	B	GRM188B11C104KA01D	K22124805		1-	A	E4
C 4201	CHIP CAP.	0.1uF	16V	B	GRM188B11C104KA01D	K22124805		1-	A	H3
C 4202	CHIP CAP.	47pF	50V	CH	GRM188C1H470JA01D	K22174227		1-	A	G4
C 4203	CHIP CAP.	68pF	50V	CH	GRM188C1H680JA01D	K22174231		1-	A	G4
C 4204	CHIP CAP.	0.01uF	50V	B	GRM188B11H103KA01D	K22174823		1-	A	E4
C 4205	CHIP CAP.	0.01uF	50V	B	GRM188B11H103KA01D	K22174823		1-	A	E4
C 4206	CHIP CAP.	0.01uF	50V	B	GRM188B11H103KA01D	K22174823		1-	A	H3
C 4207	CHIP CAP.	0.01uF	50V	B	GRM188B11H103KA01D	K22174823		1-	A	H3
C 4208	CHIP CAP.	120pF	50V	CH	GRM188C1H121JA01D	K22174237		1-	A	E4
C 4209	CHIP CAP.	0.1uF	16V	B	GRM188B11C104KA01D	K22124805		1-	B	d4
C 4210	CHIP CAP.	82pF	50V	CH	GRM188C1H820JA01D	K22174233		1-	A	E4
C 4211	CHIP CAP.	0.1uF	16V	B	GRM188B11C104KA01D	K22124805		1-	B	d4
C 4212	CHIP CAP.	120pF	50V	CH	GRM188C1H121JA01D	K22174237		1-	A	H3
C 4213	CHIP CAP.	0.1uF	16V	B	GRM188B11C104KA01D	K22124805		1-	B	a3
C 4214	CHIP CAP.	82pF	50V	CH	GRM188C1H820JA01D	K22174233		1-	A	H3
C 4215	CHIP CAP.	0.1uF	16V	B	GRM188B11C104KA01D	K22124805		1-	B	a3
C 4216	CHIP CAP.	0.01uF	50V	B	GRM188B11H103KA01D	K22174823		1-	B	b5
C 4217	CHIP CAP.	68pF	50V	CH	GRM188C1H680JA01D	K22174231		1-	A	G4
C 4218	CHIP CAP.	22pF	50V	CH	GRM188C1H220JA01D	K22174219		1-	A	E4
C 4219	CHIP CAP.	11pF	50V	CH	GRM188C1H110JZ01D	K22174212		1-	A	E4
C 4220	CHIP CAP.	22pF	50V	CH	GRM188C1H220JA01D	K22174219		1-	A	H3

LOCAL Unit

Parts List

REF	DESCRIPTION	VALUE	V/W	TOL.	MFR'S DESIG	VXSTD P/N	VERS.	LOT	SIDE	LAY ADR
C 4221	CHIP CAP.	11pF	50V	CH	GRM1882C1H110JZ01D	K22174212		1-	A	H3
C 4222	CHIP CAP.	68pF	50V	CH	GRM1882C1H680JA01D	K22174231		1-	A	G4
C 4223	CHIP CAP.	0.01uF	50V	B	GRM188B11H103KA01D	K22174823		1-	B	d5
C 4224	CHIP CAP.	0.01uF	50V	B	GRM188B11H103KA01D	K22174823		1-	B	e5
C 4225	CHIP CAP.	0.01uF	50V	B	GRM188B11H103KA01D	K22174823		1-	B	b1
C 4226	CHIP CAP.	0.01uF	50V	B	GRM188B11H103KA01D	K22174823		1-	B	a2
C 4227	CHIP CAP.	180pF	50V	CH	GRM1882C1H181JA01D	K22174241		1-	A	E4
C 4228	CHIP CAP.	82pF	50V	CH	GRM1882C1H820JA01D	K22174233		1-	A	E4
C 4229	CHIP CAP.	180pF	50V	CH	GRM1882C1H181JA01D	K22174241		1-	A	H2
C 4230	CHIP CAP.	82pF	50V	CH	GRM1882C1H820JA01D	K22174233		1-	A	H2
C 4231	CHIP CAP.	68pF	50V	CH	GRM1882C1H680JA01D	K22174231		1-	A	G4
C 4232	CHIP CAP.	82pF	50V	CH	GRM1882C1H820JA01D	K22174233		1-	A	E4
C 4233	CHIP CAP.	82pF	50V	CH	GRM1882C1H820JA01D	K22174233		1-	A	H2
C 4234	CHIP CAP.	0.01uF	50V	B	GRM188B11H103KA01D	K22174823		1-	B	b5
C 4235	CHIP CAP.	0.01uF	50V	B	GRM188B11H103KA01D	K22174823		1-	A	G5
C 4236	CHIP CAP.	0.01uF	50V	B	GRM188B11H103KA01D	K22174823		1-	A	G5
C 4237	CHIP CAP.	0.01uF	50V	B	GRM188B11H103KA01D	K22174823		1-	B	b5
C 4238	CHIP CAP.	22pF	50V	CH	GRM1882C1H220JA01D	K22174219		1-	A	E4
C 4239	CHIP CAP.	22pF	50V	CH	GRM1882C1H220JA01D	K22174219		1-	A	H2
C 4240	CHIP CAP.	0.1uF	16V	B	GRM188B11C104KA01D	K22124805		1-	B	d4
C 4241	CHIP CAP.	0.1uF	16V	B	GRM188B11C104KA01D	K22124805		1-	B	a2
C 4242	CHIP CAP.	68pF	50V	CH	GRM1882C1H680JA01D	K22174231		1-	A	G4
C 4243	CHIP CAP.	0.01uF	50V	B	GRM188B11H103KA01D	K22174823		1-	B	d5
C 4244	CHIP CAP.	0.01uF	50V	B	GRM188B11H103KA01D	K22174823		1-	B	d5
C 4245	CHIP CAP.	11pF	50V	CH	GRM1882C1H110JZ01D	K22174212		1-	A	E5
C 4246	CHIP CAP.	0.01uF	50V	B	GRM188B11H103KA01D	K22174823		1-	B	a2
C 4247	CHIP CAP.	0.01uF	50V	B	GRM188B11H103KA01D	K22174823		1-	B	a2
C 4248	CHIP CAP.	11pF	50V	CH	GRM1882C1H110JZ01D	K22174212		1-	A	H2
C 4249	CHIP CAP.	0.01uF	50V	B	GRM188B11H103KA01D	K22174823		1-	B	d4
C 4250	CHIP CAP.	0.1uF	16V	B	GRM188B11C104KA01D	K22124805		1-	B	e5
C 4251	CHIP CAP.	0.01uF	50V	B	GRM188B11H103KA01D	K22174823		1-	B	a2
C 4252	CHIP CAP.	0.1uF	16V	B	GRM188B11C104KA01D	K22124805		1-	B	a2
C 4253	CHIP CAP.	120pF	50V	CH	GRM1882C1H121JA01D	K22174237		1-	A	E5
C 4254	CHIP CAP.	0.01uF	50V	B	GRM188B11H103KA01D	K22174823		1-	B	e5
C 4255	CHIP CAP.	120pF	50V	CH	GRM1882C1H121JA01D	K22174237		1-	A	H2
C 4256	CHIP CAP.	0.01uF	50V	B	GRM188B11H103KA01D	K22174823		1-	B	a2
C 4257	CHIP CAP.	47pF	50V	CH	GRM1882C1H470JA01D	K22174227		1-	A	G5
C 4258	CHIP CAP.	0.001uF	50V	B	GRM188B11H102KA01D	K22174821		1-	A	G5
C 4259	CHIP CAP.	82pF	50V	CH	GRM1882C1H820JA01D	K22174233		1-	A	E5
C 4260	CHIP CAP.	82pF	50V	CH	GRM1882C1H820JA01D	K22174233		1-	A	H2
C 4261	CHIP CAP.	0.01uF	50V	B	GRM188B11H103KA01D	K22174823		1-	A	G5
C 4262	CHIP CAP.	0.01uF	50V	B	GRM188B11H103KA01D	K22174823		1-	B	b5
C 4267	CHIP CAP.	0.01uF	50V	B	GRM188B11H103KA01D	K22174823		1-	A	G5
C 4268	CHIP CAP.	0.01uF	50V	B	GRM188B11H103KA01D	K22174823		1-	B	d5
C 4269	CHIP CAP.	0.01uF	50V	B	GRM188B11H103KA01D	K22174823		1-	B	b1
C 4270	CHIP CAP.	0.01uF	50V	B	GRM188B11H103KA01D	K22174823		1-	A	G5
C 4271	CHIP CAP.	0.001uF	50V	B	GRM188B11H102KA01D	K22174821		1-	A	G5
C 4272	CHIP CAP.	0.001uF	50V	B	GRM188B11H102KA01D	K22174821		1-	A	G5
C 4277	CHIP CAP.	0.01uF	50V	B	GRM188B11H103KA01D	K22174823		1-	A	G5
C 4280	CHIP CAP.	0.01uF	50V	B	GRM188B11H103KA01D	K22174823		1-	A	E5
C 4281	CHIP CAP.	0.01uF	50V	B	GRM188B11H103KA01D	K22174823		1-	A	H2
C 4282	CHIP CAP.	0.01uF	50V	B	GRM188B11H103KA01D	K22174823		1-	A	F5
C 4283	CHIP CAP.	0.01uF	50V	B	GRM188B11H103KA01D	K22174823		1-	A	H2
C 4284	CHIP CAP.	0.1uF	16V	B	GRM188B11C104KA01D	K22124805		1-	B	c5
C 4285	CHIP CAP.	0.01uF	50V	B	GRM188B11H103KA01D	K22174823		1-	B	d5
C 4286	CHIP CAP.	0.01uF	50V	B	GRM188B11H103KA01D	K22174823		1-	A	H1
C 4287	CHIP CAP.	0.001uF	50V	B	GRM188B11H102KA01D	K22174821		1-	A	H2
C 4288	CHIP CAP.	0.01uF	50V	B	GRM188B11H103KA01D	K22174823		1-	B	b5
C 4289	CHIP CAP.	0.001uF	50V	B	GRM188B11H102KA01D	K22174821		1-	A	E5
C 4290	CHIP CAP.	0.01uF	50V	B	GRM188B11H103KA01D	K22174823		1-	A	E5
C 4291	CHIP CAP.	0.001uF	50V	B	GRM188B11H102KA01D	K22174821		1-	A	F5
C 4292	CHIP CAP.	0.01uF	50V	B	GRM188B11H103KA01D	K22174823		1-	A	H2
C 4293	CHIP CAP.	0.001uF	50V	B	GRM188B11H102KA01D	K22174821		1-	A	H2
C 4294	CHIP CAP.	180pF	50V	CH	GRM1882C1H181JA01D	K22174241		1-	A	G5
C 4295	CHIP CAP.	0.1uF	16V	B	GRM188B11C104KA01D	K22124805		1-	B	d5
C 4296	CHIP CAP.	0.1uF	16V	B	GRM188B11C104KA01D	K22124805		1-	B	b1
C 4297	CHIP CAP.	0.01uF	50V	B	GRM188B11H103KA01D	K22174823		1-	A	G5
C 4298	CHIP CAP.	0.01uF	50V	B	GRM188B11H103KA01D	K22174823		1-	A	G5
C 4299	CHIP CAP.	0.01uF	50V	B	GRM188B11H103KA01D	K22174823		1-	A	H5
C 4300	CHIP CAP.	0.01uF	50V	B	GRM188B11H103KA01D	K22174823		1-	A	H5
C 4301	CHIP CAP.	0.1uF	16V	B	GRM188B11C104KA01D	K22124805		1-	B	e5
C 4302	CHIP CAP.	0.1uF	16V	B	GRM188B11C104KA01D	K22124805		1-	A	H2
C 4303	CHIP CAP.	12pF	50V	CH	GRM1882C1H120JA01D	K22174213		1-	A	G6

LOCAL Unit

Parts List

REF	DESCRIPTION	VALUE	V/W	TOL.	MFR'S DESIG	VXSTD P/N	VERS.	LOT	SIDE	LAY ADR
C 4304	CHIP CAP.	0.01uF	50V	B	GRM188B11H103KA01D	K22174823		1-	A	E5
C 4305	CHIP CAP.	0.01uF	50V	B	GRM188B11H103KA01D	K22174823		1-	A	H2
C 4306	CHIP CAP.	0.1uF	16V	B	GRM188B11C104KA01D	K22124805		1-	A	G6
C 4307	CHIP CAP.	330pF	50V	CH	GRM1882C1H331JA01D	K22174253		1-	A	G6
C 4308	CHIP CAP.	0.01uF	50V	B	GRM188B11H103KA01D	K22174823		1-	A	G5
C 4309	CHIP CAP.	0.01uF	50V	B	GRM188B11H103KA01D	K22174823		1-	A	E5
C 4310	CHIP CAP.	0.01uF	50V	B	GRM188B11H103KA01D	K22174823		1-	A	H2
C 4311	CHIP CAP.	0.001uF	50V	B	GRM188B11H102KA01D	K22174821		1-	A	F5
C 4312	CHIP CAP.	33pF	50V	CH	GRM1882C1H330JA01D	K22174223		1-	A	E5
C 4313	CHIP CAP.	0.001uF	50V	B	GRM188B11H102KA01D	K22174821		1-	A	H2
C 4314	CHIP CAP.	33pF	50V	CH	GRM1882C1H330JA01D	K22174223		1-	A	H1
C 4315	CHIP CAP.	0.001uF	50V	B	GRM188B11H102KA01D	K22174821		1-	A	E5
C 4316	CHIP CAP.	0.001uF	50V	B	GRM188B11H102KA01D	K22174821		1-	A	H2
C 4317	CHIP CAP.	56pF	50V	CH	GRM1882C1H560JA01D	K22174229		1-	A	G5
C 4318	CHIP CAP.	18pF	50V	CH	GRM1882C1H180JA01D	K22174217		1-	A	G5
C 4319	CHIP CAP.	0.1uF	16V	B	GRM188B11C104KA01D	K22124805		1-	A	H5
C 4320	CHIP CAP.	12pF	50V	CH	GRM1882C1H120JA01D	K22174213		1-	A	H6
C 4321	CHIP CAP.	0.1uF	16V	B	GRM188B11C104KA01D	K22124805		1-	A	G6
C 4322	CHIP CAP.	22pF	50V	CH	GRM1882C1H220JA01D	K22174219		1-	A	F5
C 4323	CHIP CAP.	22pF	50V	CH	GRM1882C1H220JA01D	K22174219		1-	A	G2
C 4324	CHIP CAP.	0.01uF	50V	B	GRM188B11H103KA01D	K22174823		1-	A	G5
C 4325	CHIP CAP.	56pF	50V	CH	GRM1882C1H560JA01D	K22174229		1-	A	E5
C 4326	CHIP CAP.	56pF	50V	CH	GRM1882C1H560JA01D	K22174229		1-	A	H1
C 4327	CHIP CAP.	100pF	50V	CH	GRM1882C1H101JA01D	K22174235		1-	A	H5
C 4328	CHIP CAP.	30pF	50V	CH	GRM1882C1H300JZ01D	K22174222		1-	A	H5
C 4329	CHIP CAP.	0.01uF	50V	B	GRM188B11H103KA01D	K22174823		1-	A	H6
C 4330	CHIP CAP.	39pF	50V	CH	GRM1882C1H390JA01D	K22174225		1-	A	F5
C 4331	CHIP CAP.	39pF	50V	CH	GRM1882C1H390JA01D	K22174225		1-	A	G2
C 4332	CHIP CAP.	150pF	50V	CH	GRM1882C1H151JA01D	K22174239		1-	A	H6
C 4333	CHIP CAP.	22pF	50V	CH	GRM1882C1H220JA01D	K22174219		1-	A	E5
C 4334	CHIP CAP.	22pF	50V	CH	GRM1882C1H220JA01D	K22174219		1-	A	H1
C 4335	CHIP CAP.	56pF	50V	CH	GRM1882C1H560JA01D	K22174229		1-	A	H5
C 4336	CHIP CAP.	18pF	50V	CH	GRM1882C1H180JA01D	K22174217		1-	A	H5
C 4337	CHIP CAP.	22pF	50V	CH	GRM1882C1H220JA01D	K22174219		1-	A	F5
C 4338	CHIP CAP.	22pF	50V	CH	GRM1882C1H220JA01D	K22174219		1-	A	G1
C 4339	CHIP CAP.	0.01uF	50V	B	GRM188B11H103KA01D	K22174823		1-	B	a5
C 4340	CHIP CAP.	0.1uF	16V	B	GRM188B11C104KA01D	K22124805		1-	A	H5
C 4341	CHIP CAP.	0.1uF	16V	B	GRM188B11C104KA01D	K22124805		1-	A	F6
C 4342	CHIP CAP.	0.1uF	16V	B	GRM188B11C104KA01D	K22124805		1-	A	G1
C 4343	CHIP CAP.	0.01uF	50V	B	GRM188B11H103KA01D	K22174823		1-	A	H5
C 4344	CHIP CAP.	0.01uF	50V	B	GRM188B11H103KA01D	K22174823		1-	A	F6
C 4345	CHIP CAP.	0.01uF	50V	B	GRM188B11H103KA01D	K22174823		1-	A	G1
C 4346	CHIP CAP.	0.001uF	50V	B	GRM188B11H102KA01D	K22174821		1-	B	a6
C 4347	CHIP CAP.	0.001uF	50V	B	GRM188B11H102KA01D	K22174821		1-	B	d5
C 4348	CHIP CAP.	0.001uF	50V	B	GRM188B11H102KA01D	K22174821		1-	B	a1
C 4349	CHIP CAP.	0.1uF	16V	B	GRM188B11C104KA01D	K22124805		1-	A	H6
C 4350	CHIP CAP.	0.01uF	50V	B	GRM188B11H103KA01D	K22174823		1-	A	H6
C 4351	CHIP CAP.	0.01uF	50V	B	GRM188B11H103KA01D	K22174823		1-	B	d5
C 4352	CHIP CAP.	0.01uF	50V	B	GRM188B11H103KA01D	K22174823		1-	B	a1
C 4353	CHIP CAP.	0.01uF	50V	B	GRM188B11H103KA01D	K22174823		1-	A	H6
C 4354	CHIP CAP.	0.01uF	50V	B	GRM188B11H103KA01D	K22174823		1-	B	a5
C 4355	CHIP CAP.	0.001uF	50V	B	GRM188B11H102KA01D	K22174821		1-	B	a6
C 4356	CHIP CAP.	0.01uF	50V	B	GRM188B11H103KA01D	K22174823		1-	B	d5
C 4357	CHIP CAP.	0.001uF	50V	B	GRM188B11H102KA01D	K22174821		1-	B	d6
C 4358	CHIP CAP.	0.01uF	50V	B	GRM188B11H103KA01D	K22174823		1-	B	b1
C 4359	CHIP CAP.	0.001uF	50V	B	GRM188B11H102KA01D	K22174821		1-	B	a1
C 4360	CHIP CAP.	0.01uF	50V	B	GRM188B11H103KA01D	K22174823		1-	B	a6
C 4361	CHIP CAP.	0.001uF	50V	B	GRM188B11H102KA01D	K22174821		1-	A	l6
C 4362	CHIP CAP.	0.01uF	50V	B	GRM188B11H103KA01D	K22174823		1-	B	d6
C 4363	CHIP CAP.	0.001uF	50V	B	GRM188B11H102KA01D	K22174821		1-	B	d6
C 4364	CHIP CAP.	0.01uF	50V	B	GRM188B11H103KA01D	K22174823		1-	B	a1
C 4365	CHIP CAP.	0.001uF	50V	B	GRM188B11H102KA01D	K22174821		1-	B	a1
C 4366	CHIP CAP.	39pF	50V	CH	GRM1882C1H390JA01D	K22174225		1-	A	l5
C 4367	CHIP CAP.	27pF	50V	CH	GRM1882C1H270JA01D	K22174221		1-	B	d6
C 4368	CHIP CAP.	27pF	50V	CH	GRM1882C1H270JA01D	K22174221		1-	B	a1
C 4369	CHIP CAP.	82pF	50V	CH	GRM1882C1H820JA01D	K22174233		1-	A	l5
C 4370	CHIP CAP.	56pF	50V	CH	GRM1882C1H560JA01D	K22174229		1-	B	d6
C 4371	CHIP CAP.	56pF	50V	CH	GRM1882C1H560JA01D	K22174229		1-	B	a1
C 4372	CHIP CAP.	39pF	50V	CH	GRM1882C1H390JA01D	K22174225		1-	A	l5
C 4373	CHIP CAP.	27pF	50V	CH	GRM1882C1H270JA01D	K22174221		1-	B	e6
C 4374	CHIP CAP.	27pF	50V	CH	GRM1882C1H270JA01D	K22174221		1-	B	a1
C 4378	CHIP CAP.	0.001uF	50V	B	GRM188B11H102KA01D	K22174821		1-	A	E3
C 4379	CHIP CAP.	0.1uF	16V	B	GRM188B11C104KA01D	K22124805		1-	B	e3

LOCAL Unit

Parts List

REF	DESCRIPTION	VALUE	V/W	TOL.	MFR'S DESIG	VXSTD P/N	VERS.	LOT	SIDE	LAY ADR
C 4380	CHIP CAP.	0.1uF	16V	B	GRM188B11C104KA01D	K22124805		1-	A	E2
C 4381	CHIP CAP.	0.001uF	50V	B	GRM188B11H102KA01D	K22174821		1-	A	H4
C 4382	CHIP CAP.	0.001uF	50V	B	GRM188B11H102KA01D	K22174821		1-	A	F4
C 4383	CHIP CAP.	0.001uF	50V	B	GRM188B11H102KA01D	K22174821		1-	A	G3
C 4384	CHIP CAP.	150pF	50V	CH	GRM1882C1H151JA01D	K22174239		1-	A	B3
C 4385	CHIP CAP.	0.0022uF	50V	B	GRM188B11H222KA01D	K22174822		1-	A	A2
C 4386	CHIP CAP.	10pF	50V	CH	GRM1882C1H100JA01D	K22174211	W/TCXO	1-	A	D5
C 4387	CHIP CAP.	33pF	50V	CH	GRM1882C1H330JA01D	K22174223		1-	A	H6
C 4388	CHIP CAP.	10pF	50V	CH	GRM1882C1H100JA01D	K22174211		1-	A	E5
C 4389	CHIP CAP.	10pF	50V	CH	GRM1882C1H100JA01D	K22174211		1-	A	H1
D 4001	DIODE				UDZS TE-17 5.1B	G2070908		1-	A	E2
D 4002	DIODE				BAS316	G2070716		1-	A	C3
D 4003	DIODE				BAS316	G2070716		1-	A	C2
D 4004	DIODE				UDZS TE-17 6.2B	G2070912		1-	A	D2
D 4005	DIODE				BAS316	G2070716		1-	A	H5
D 4006	DIODE				BAS316	G2070716		1-	A	F5
D 4007	DIODE				BAS316	G2070716		1-	A	G2
D 4008	DIODE				BAS316	G2070716		1-	B	b6
D 4009	DIODE				BAS316	G2070716		1-	B	b6
D 4010	DIODE				RN142S TE61	G2070994		1-	A	E4
D 4011	DIODE				RN142S TE61	G2070994		1-	A	E4
D 4012	DIODE				RN142S TE61	G2070994		1-	A	H3
D 4013	DIODE				RN142S TE61	G2070994		1-	A	H3
D 4014	DIODE				RN142S TE61	G2070994		1-	A	E5
D 4015	DIODE				RN142S TE61	G2070994		1-	A	E5
D 4016	DIODE				RN142S TE61	G2070994		1-	A	H2
D 4017	DIODE				RN142S TE61	G2070994		1-	A	H2
D 4018	DIODE				RN142S TE61	G2070994		1-	A	G5
D 4019	DIODE				RN142S TE61	G2070994		1-	A	G5
D 4020	DIODE				RN142S TE61	G2070994		1-	A	E5
D 4021	DIODE				RN142S TE61	G2070994		1-	A	E5
D 4022	DIODE				RN142S TE61	G2070994		1-	A	H2
D 4023	DIODE				RN142S TE61	G2070994		1-	A	H2
D 4024	DIODE				RN142S TE61	G2070994		1-	A	G5
D 4025	DIODE				RN142S TE61	G2070994		1-	A	G5
D 4026	DIODE				RN142S TE61	G2070994		1-	A	H6
D 4027	DIODE				RN142S TE61	G2070994		1-	A	E5
D 4028	DIODE				RN142S TE61	G2070994		1-	A	H1
D 4029	DIODE				RN142S TE61	G2070994		1-	A	H5
D 4030	DIODE				RN142S TE61	G2070994		1-	A	H5
D 4031	DIODE				RN142S TE61	G2070994		1-	A	H6
D 4032	DIODE				RN142S TE61	G2070994		1-	A	E5
D 4033	DIODE				RN142S TE61	G2070994		1-	A	H1
D 4034	DIODE				RN142S TE61	G2070994		1-	A	H6
D 4035	DIODE				RN142S TE61	G2070994		1-	A	E5
D 4036	DIODE				RN142S TE61	G2070994		1-	A	H1
D 4037	DIODE				RN142S TE61	G2070994		1-	A	G5
FB4001	FERRITE BEADS				BLM18BD601SN1D	L9190143		1-	A	A4
FB4002	FERRITE BEADS				BLM18BD601SN1D	L9190143		1-	A	A4
FB4003	FERRITE BEADS				BLM18BD601SN1D	L9190143		1-	A	A4
FB4004	FERRITE BEADS				BLM18BD601SN1D	L9190143		1-	A	A4
FB4005	FERRITE BEADS				BLM18BD601SN1D	L9190143		1-	A	A4
FB4006	FERRITE BEADS				BLM18BD601SN1D	L9190143		1-	A	A4
FB4007	FERRITE BEADS				BLM18BD601SN1D	L9190143		1-	A	A4
FB4008	FERRITE BEADS				BLM18BD601SN1D	L9190143		1-	A	A4
FB4009	FERRITE BEADS				BLM18BD601SN1D	L9190143		1-	A	A4
FB4010	FERRITE BEADS				BLM18BD601SN1D	L9190143		1-	A	A4
FB4011	FERRITE BEADS				BLM18BD601SN1D	L9190143		1-	A	A4
FB4012	FERRITE BEADS				BLM18BD601SN1D	L9190143		1-	A	A4
FB4013	FERRITE BEADS				BLM18BD601SN1D	L9190143		1-	A	A4
FB4014	FERRITE BEADS				BLM18BD601SN1D	L9190143		1-	A	A4
FB4015	FERRITE BEADS				BLM18BD601SN1D	L9190143		1-	A	A4
FB4016	FERRITE BEADS				BLM18BD601SN1D	L9190143		1-	A	A4
FB4017	FERRITE BEADS				BLM18BD601SN1D	L9190143		1-	A	A4
FB4018	FERRITE BEADS				BLM18BD601SN1D	L9190143		1-	A	A4
FB4019	FERRITE BEADS				BLM18BD601SN1D	L9190143		1-	A	A4
FB4020	FERRITE BEADS				BLM18PG600SN1D	L1690601		1-	A	A4
FB4021	FERRITE BEADS				BLM18PG600SN1D	L1690601		1-	A	A4
FB4022	FERRITE BEADS				BLM18PG600SN1D	L1690601		1-	A	A4
FB4023	FERRITE BEADS				BLM18PG600SN1D	L1690601		1-	A	A5
FB4024	FERRITE BEADS				BK2125HS101-T	L9190087		1-	A	F5
FB4025	FERRITE BEADS				BK2125HS101-T	L9190087		1-	A	G2
FB4026	FERRITE BEADS				BK2125HS101-T	L9190087		1-	A	H5

LOCAL Unit

Parts List

REF	DESCRIPTION	VALUE	V/W	TOL.	MFR'S DESIG	VXSTD P/N	VERS.	LOT	SIDE	LAY ADR
FB4027	FERRITE BEADS				BK2125HS101-T	L9190087		1-	B	b5
FB4028	FERRITE BEADS				BK2125HS101-T	L9190087		1-	B	c5
FB4029	FERRITE BEADS				BK2125HS101-T	L9190087		1-	B	b2
FB4030	FERRITE BEADS				BK2125HS101-T	L9190087		1-	B	b5
FB4031	FERRITE BEADS				BK2125HS101-T	L9190087		1-	B	d5
FB4032	FERRITE BEADS				BK2125HS101-T	L9190087		1-	B	b2
J 4001	CONNECTOR				TMP-J01X-V6	P1090210		1-	A	C4
J 4002	CONNECTOR				TMP-J01X-V6	P1090210		1-	A	B4
J 4003	CONNECTOR				TMP-J01X-V6	P1090210		1-	A	A3
J 4004	CONNECTOR				TMP-J01X-V6	P1090210		1-	A	A2
J 4005	CONNECTOR				30FLT-SM2-TB(LF)(SN)(M)	P1091142		1-	A	A4
J 4006	CONNECTOR				TMP-J01X-V6	P1090210		1-	A	F3
J 4007	CONNECTOR				TMP-J01X-V6	P1090210		1-	A	I5
J 4008	CONNECTOR				TMP-J01X-V6	P1090210		1-	A	E5
J 4009	CONNECTOR				TMP-J01X-V6	P1090210		1-	A	I1
L 4001	CHIP COIL	0.18uH		2%	C2520C-R18G-RA	L1691297		1-	A	C4
L 4002	M.RFC	56uH			LLM3225-560J	L1691142		1-	A	B2
L 4003	M.RFC	68uH			LLM3225-680J	L1691143		1-	A	C2
L 4004	M.RFC	56uH			LLM3225-560J	L1691142		1-	A	C2
L 4005	M.RFC	1uH			LK1608 1R0K-T	L1690687		1-	A	C4
L 4006	M.RFC	1uH			LK1608 1R0K-T	L1690687		1-	A	C3
L 4007	M.RFC	1uH			LK1608 1R0K-T	L1690687		1-	A	C4
L 4008	M.RFC	1uH			LK1608 1R0K-T	L1690687		1-	A	C3
L 4009	CHIP COIL	0.33uH		5%	NLV-25T-R33J-PF	L1691418		1-	A	E3
L 4010	M.RFC	4.7uH			LK1608 4R7K-T	L1690688		1-	B	e4
L 4011	M.RFC	4.7uH			LK1608 4R7K-T	L1690688		1-	B	e4
L 4012	CHIP COIL	0.18uH		2%	C2520C-R18G-RA	L1691297		1-	A	D4
L 4013	M.RFC	1uH			LK1608 1R0K-T	L1690687		1-	A	H4
L 4014	M.RFC	1uH			LK1608 1R0K-T	L1690687		1-	A	F4
L 4015	M.RFC	1uH			LK1608 1R0K-T	L1690687		1-	A	G3
L 4016	M.RFC	0.18uH		2%	C2012C-R18G-RA	L1690779		1-	A	G4
L 4017	M.RFC	0.12uH		2%	C2012C-R12G-RA	L1690777		1-	A	G4
L 4018	M.RFC	0.068uH		2%	C1608CB-68NG-RF	L1691042		1-	A	E4
L 4019	M.RFC	0.047uH		2%	C1608CB-47NG-RF	L1691040		1-	A	E4
L 4020	M.RFC	0.068uH		2%	C1608CB-68NG-RF	L1691042		1-	A	H3
L 4021	M.RFC	0.047uH		2%	C1608CB-47NG-RF	L1691040		1-	A	H3
L 4022	M.RFC	0.1uH		2%	C2012C-R10G-RA	L1690776		1-	A	G4
L 4023	M.RFC	0.33uH		2%	C1608CB-R33G-RF	L1691106		1-	A	E4
L 4024	M.RFC	0.33uH		2%	C1608CB-R33G-RF	L1691106		1-	A	E4
L 4025	M.RFC	0.33uH		2%	C1608CB-R33G-RF	L1691106		1-	A	H3
L 4026	M.RFC	0.33uH		2%	C1608CB-R33G-RF	L1691106		1-	A	H3
L 4027	M.RFC	0.15uH		2%	C2012C-R15G-RA	L1690778		1-	A	G4
L 4028	M.RFC	0.039uH		2%	C1608CB-39NG-RF	L1691039		1-	A	E4
L 4029	M.RFC	0.022uH		2%	C1608CB-22NG-RF	L1691036		1-	A	E4
L 4030	M.RFC	0.039uH		2%	C1608CB-39NG-RF	L1691039		1-	A	H2
L 4031	M.RFC	0.022uH		2%	C1608CB-22NG-RF	L1691036		1-	A	H2
L 4032	M.RFC	0.1uH		2%	C2012C-R10G-RA	L1690776		1-	A	G4
L 4033	M.RFC	0.33uH		2%	C1608CB-R33G-RF	L1691106		1-	A	E4
L 4034	M.RFC	0.33uH		2%	C1608CB-R33G-RF	L1691106		1-	A	H2
L 4035	M.RFC	0.12uH		2%	C2012C-R12G-RA	L1690777		1-	A	G4
L 4036	M.RFC	0.33uH		2%	C1608CB-R33G-RF	L1691106		1-	A	E4
L 4037	M.RFC	0.33uH		2%	C1608CB-R33G-RF	L1691106		1-	A	H2
L 4038	M.RFC	0.068uH		2%	C1608CB-68NG-RF	L1691042		1-	A	E5
L 4039	M.RFC	0.068uH		2%	C1608CB-68NG-RF	L1691042		1-	A	H2
L 4040	M.RFC	0.18uH		2%	C2012C-R18G-RA	L1690779		1-	A	G4
L 4041	M.RFC	0.047uH		2%	C1608CB-47NG-RF	L1691040		1-	A	E5
L 4042	M.RFC	0.047uH		2%	C1608CB-47NG-RF	L1691040		1-	A	H2
L 4043	M.RFC	22uH			LK1608 220M-T	L1691030		1-	A	G5
L 4044	M.RFC	1uH			LK1608 1R0K-T	L1690687		1-	B	b5
L 4047	M.RFC	22uH			LK1608 220M-T	L1691030		1-	A	E5
L 4048	M.RFC	22uH			LK1608 220M-T	L1691030		1-	A	H2
L 4049	M.RFC	1uH			LK1608 1R0K-T	L1690687		1-	A	F5
L 4050	M.RFC	1uH			LK1608 1R0K-T	L1690687		1-	A	H2
L 4051	M.RFC	0.039uH		2%	C2012C-39NG-RA	L1690771		1-	A	G5
L 4052	CHIP COIL	0.56uH		2%	C2520C-R56G-RA	L1691303		1-	A	G5
L 4055	M.RFC	22uH			LK1608 220M-T	L1691030		1-	A	H5
L 4056	M.RFC	0.022uH		2%	C2012C-22NG-RA	L1690768		1-	A	G6
L 4057	M.RFC	22uH			LK1608 220M-T	L1691030		1-	A	G5
L 4058	M.RFC	22uH			LK1608 220M-T	L1691030		1-	A	G5
L 4059	CHIP COIL	0.56uH		2%	C2520C-R56G-RA	L1691303		1-	A	G6
L 4060	M.RFC	0.1uH		2%	C1608CB-R10G-RF	L1691045		1-	A	E5
L 4061	M.RFC	0.1uH		2%	C1608CB-R10G-RF	L1691045		1-	A	H1
L 4062	CHIP COIL	2.7uH		2%	C2520C-2R7G-RA	L1691314		1-	A	H5

LOCAL Unit

Parts List

REF	DESCRIPTION	VALUE	V/W	TOL.	MFR'S DESIG	VXSTD P/N	VERS.	LOT	SIDE	LAY ADR
L 4063	CHIP COIL	0.82uH		2%	C2520C-R82G-RA	L1691307		1-	A	H5
L 4064	CHIP COIL	1uH		2%	C2520C-1R0G-RA	L1691309		1-	A	F5
L 4065	CHIP COIL	1uH		2%	C2520C-1R0G-RA	L1691309		1-	A	H2
L 4066	M.RFC	0.1uH		2%	C1608CB-R10G-RF	L1691045		1-	A	E5
L 4067	M.RFC	0.1uH		2%	C1608CB-R10G-RF	L1691045		1-	A	H1
L 4068	M.RFC	0.039uH		2%	C2012C-39NG-RA	L1690771		1-	A	H6
L 4069	CHIP COIL	2.7uH		2%	C2520C-2R7G-RA	L1691314		1-	A	H5
L 4070	CHIP COIL	0.82uH		2%	C2520C-R82G-RA	L1691307		1-	A	H5
L 4071	CHIP COIL	1uH		2%	C2520C-1R0G-RA	L1691309		1-	A	F5
L 4072	CHIP COIL	1uH		2%	C2520C-1R0G-RA	L1691309		1-	A	H2
L 4073	M.RFC	22uH			LK1608 220M-T	L1691030		1-	A	H6
L 4074	M.RFC	22uH			LK1608 220M-T	L1691030		1-	B	d5
L 4075	M.RFC	22uH			LK1608 220M-T	L1691030		1-	B	a1
L 4076	M.RFC	1uH			LK1608 1R0K-T	L1690687		1-	B	a5
L 4077	M.RFC	1uH			LK1608 1R0K-T	L1690687		1-	B	d6
L 4078	M.RFC	1uH			LK1608 1R0K-T	L1690687		1-	B	b1
L 4079	M.RFC	0.18uH		2%	C2012C-R18G-RA	L1690779		1-	A	I5
L 4080	M.RFC	0.082uH		2%	C1608CB-82NG-RF	L1691044		1-	B	d6
L 4081	M.RFC	0.082uH		2%	C1608CB-82NG-RF	L1691044		1-	B	a1
L 4082	M.RFC	0.18uH		2%	C2012C-R18G-RA	L1690779		1-	A	I5
L 4083	M.RFC	0.082uH		2%	C1608CB-82NG-RF	L1691044		1-	B	e6
L 4084	M.RFC	0.082uH		2%	C1608CB-82NG-RF	L1691044		1-	B	a1
L 4088	M.RFC	22uH			LK1608 220M-T	L1691030		1-	B	d4
L 4089	M.RFC	22uH			LK1608 220M-T	L1691030		1-	B	d4
L 4090	M.RFC	22uH			LK1608 220M-T	L1691030		1-	B	a3
L 4091	M.RFC	22uH			LK1608 220M-T	L1691030		1-	B	a3
L 4092	M.RFC	22uH			LK1608 220M-T	L1691030		1-	A	G6
MD4001	VCO MODULE				SV399ER1607	Q7000627		1-	A	E3
Q 4001	IC				NJM2904V-TE1	G1091677		1-	A	A5
Q 4002	TRANSISTOR				2SC4081 T106 R	G3340818R		1-	A	B2
Q 4003	TRANSISTOR				2SC4081 T106 R	G3340818R		1-	A	B2
Q 4004	TRANSISTOR				2SC4400-4-TL	G3344008D		1-	A	B3
Q 4005	TRANSISTOR				2SC4400-4-TL	G3344008D		1-	A	C4
Q 4006	IC				AD9834BRUZ-REEL7	G1094297		1-	A	C3
Q 4007	IC				AD9834BRUZ-REEL7	G1094297		1-	A	C2
Q 4008	TRANSISTOR				2SC4400-4-TL	G3344008D	W/OCXO	1-	B	f6
Q 4009	TRANSISTOR				2SC4081 T106 R	G3340818R		1-	B	f3
Q 4010	TRANSISTOR				2SA1576A T106 R	G3115768R		1-	B	f4
Q 4011	IC				BAJ2CC0FP	G1094174	W/OCXO	1-	B	i5
Q 4011	IC				UPC2933BT-E1-AZ	G1094338	W/TCXO	1-	B	i5
Q 4012	IC				ADF4116BRU(TAPE)	G1093581		1-	B	e4
Q 4013	TRANSISTOR				2SC4081 T106 R	G3340818R		1-	A	E2
Q 4014	TRANSISTOR				2SC4400-4-TL	G3344008D		1-	A	D4
Q 4015	TRANSISTOR				2SC4400-4-TL	G3344008D		1-	A	D4
Q 4016	TRANSISTOR				2SC4400-4-TL	G3344008D	W/OCXO	1-	B	f5
Q 4017	TRANSISTOR				2SC4081 T106 R	G3340818R		1-	A	D2
Q 4018	TRANSISTOR				2SC4081 T106 R	G3340818R		1-	A	D2
Q 4019	TRANSISTOR				2SC4400-4-TL	G3344008D		1-	A	C3
Q 4020	TRANSISTOR				2SC4400-4-TL	G3344008D		1-	A	C2
Q 4021	TRANSISTOR				2SC4400-4-TL	G3344008D		1-	A	D4
Q 4022	IC				BA05FP-E2	G1093209		1-	B	d2
Q 4023	IC				BA18BC0FP-E2	G1094034		1-	B	e5
Q 4024	IC				TA4001F(TE85L)	G1092752		1-	A	H4
Q 4025	IC				TA4001F(TE85L)	G1092752		1-	A	F4
Q 4026	IC				TA4001F(TE85L)	G1092752		1-	A	G3
Q 4027	IC				AD9951YSVZ-REEL7	G1094023		1-	A	H4
Q 4028	IC				AD9951YSVZ-REEL7	G1094023		1-	A	F4
Q 4029	IC				AD9951YSVZ-REEL7	G1094023		1-	A	G2
Q 4030	TRANSISTOR				2SC4081 T106 R	G3340818R		1-	B	b6
Q 4031	TRANSISTOR				2SC4081 T106 R	G3340818R		1-	B	d5
Q 4032	TRANSISTOR				2SC4081 T106 R	G3340818R		1-	B	d5
Q 4033	TRANSISTOR				2SC4081 T106 R	G3340818R		1-	B	b2
Q 4034	TRANSISTOR				2SC4081 T106 R	G3340818R		1-	B	b2
Q 4035	TRANSISTOR				2SA1576A T106 R	G3115768R		1-	B	b5
Q 4036	TRANSISTOR				2SC4081 T106 R	G3340818R		1-	B	b5
Q 4037	TRANSISTOR				2SC4081 T106 R	G3340818R		1-	B	b5
Q 4038	TRANSISTOR				2SC4081 T106 R	G3340818R		1-	B	c6
Q 4039	TRANSISTOR				2SC4081 T106 R	G3340818R		1-	B	d5
Q 4040	TRANSISTOR				2SC4081 T106 R	G3340818R		1-	B	d5
Q 4041	TRANSISTOR				2SC4081 T106 R	G3340818R		1-	B	b2
Q 4042	TRANSISTOR				2SC4081 T106 R	G3340818R		1-	B	b2
Q 4043	TRANSISTOR				2SA1576A T106 R	G3115768R		1-	A	F5
Q 4044	TRANSISTOR				2SA1576A T106 R	G3115768R		1-	A	H2

LOCAL Unit

Parts List

REF	DESCRIPTION	VALUE	V/W	TOL.	MFR'S DESIG	VXSTD P/N	VERS.	LOT	SIDE	LAY ADR
Q 4045	IC				UPB1509GV-E1	G1093149		1-	A	G5
Q 4046	IC				UPB1509GV-E1	G1093149		1-	A	E5
Q 4047	IC				UPB1509GV-E1	G1093149		1-	A	H2
Q 4048	IC				TA4002F(TE85L.F)	G1092813		1-	B	a6
Q 4049	IC				TA4002F(TE85L.F)	G1092813		1-	B	d6
Q 4050	IC				TA4002F(TE85L.F)	G1092813		1-	B	a1
Q 4051	TRANSISTOR				2SC4081 T106 R	G3340818R		1-	B	c5
Q 4052	TRANSISTOR				2SC4081 T106 R	G3340818R		1-	B	b2
Q 4053	TRANSISTOR				2SC4081 T106 R	G3340818R		1-	B	b5
R 4001	CHIP RES.	47	1/16W	5%	RMC1/16 470JATP	J24185470		1-	A	B2
R 4002	CHIP RES.	100	1/16W	5%	RMC1/16 101JATP	J24185101		1-	A	C4
R 4003	CHIP RES.	47	1/16W	5%	RMC1/16 470JATP	J24185470		1-	A	B2
R 4004	CHIP RES.	47	1/16W	5%	RMC1/16 470JATP	J24185470		1-	A	B3
R 4005	CHIP RES.	330	1/16W	5%	RMC1/16 331JATP	J24185331		1-	A	B2
R 4006	CHIP RES.	10k	1/16W	1%	RMC1/16 103FTP	J24183103		1-	A	A5
R 4007	CHIP RES.	1k	1/16W	5%	RMC1/16 102JATP	J24185102		1-	A	B2
R 4008	CHIP RES.	10k	1/16W	1%	RMC1/16 103FTP	J24183103		1-	A	A5
R 4009	CHIP RES.	20k	1/16W	1%	RMC1/16 203FTP	J24183203	W/OCXO	1-	A	A5
R 4009	CHIP RES.	4.7k	1/16W	1%	RMC1/16 472FTP	J24183472	W/TCXO	1-	A	A5
R 4010	CHIP RES.	27k	1/16W	5%	RMC1/16 273JATP	J24185273	W/OCXO	1-	A	A5
R 4010	CHIP RES.	6.8k	1/16W	5%	RMC1/16 682JATP	J24185682	W/TCXO	1-	A	A5
R 4011	CHIP RES.	150	1/16W	5%	RMC1/16 151JATP	J24185151		1-	A	B2
R 4012	CHIP RES.	220k	1/16W	5%	RMC1/16 224JATP	J24185224		1-	A	B2
R 4013	CHIP RES.	47	1/16W	5%	RMC1/16 470JATP	J24185470		1-	A	B3
R 4014	CHIP RES.	470	1/16W	5%	RMC1/16 471JATP	J24185471		1-	A	A5
R 4015	CHIP RES.	330	1/16W	5%	RMC1/16 331JATP	J24185331		1-	A	B3
R 4016	CHIP RES.	22k	1/16W	5%	RMC1/16 223JATP	J24185223		1-	A	B3
R 4017	CHIP RES.	200	1/16W	1%	RMC1/16 201FTP	J24183201		1-	A	B2
R 4018	CHIP RES.	10	1/16W	5%	RMC1/16 100JATP	J24185100	W/OCXO	1-	A	A5
R 4019	CHIP RES.	10	1/16W	5%	RMC1/16 100JATP	J24185100	W/TCXO	1-	A	A5
R 4020	CHIP RES.	47k	1/16W	5%	RMC1/16 473JATP	J24185473		1-	A	B3
R 4021	CHIP RES.	470	1/16W	5%	RMC1/16 471JATP	J24185471		1-	A	C4
R 4022	CHIP RES.	22k	1/16W	5%	RMC1/16 223JATP	J24185223		1-	A	C4
R 4023	CHIP RES.	47k	1/16W	5%	RMC1/16 473JATP	J24185473		1-	A	C4
R 4024	CHIP RES.	47	1/16W	5%	RMC1/16 470JATP	J24185470		1-	A	C4
R 4026	CHIP RES.	5.6k	1/16W	5%	RMC1/16 562JATP	J24185562	W/OCXO	1-	B	f6
R 4027	CHIP RES.	200	1/16W	1%	RMC1/16 201FTP	J24183201		1-	A	C3
R 4028	CHIP RES.	200	1/16W	1%	RMC1/16 201FTP	J24183201		1-	A	C2
R 4029	CHIP RES.	10	1/16W	5%	RMC1/16 100JATP	J24185100		1-	A	A6
R 4030	CHIP RES.	22k	1/16W	5%	RMC1/16 223JATP	J24185223	W/OCXO	1-	B	f6
R 4031	CHIP RES.	10k	1/16W	5%	RMC1/16 103JATP	J24185103		1-	A	E3
R 4032	CHIP RES.	100	1/16W	5%	RMC1/16 101JATP	J24185101		1-	B	e3
R 4033	CHIP RES.	220	1/16W	5%	RMC1/16 221JATP	J24185221		1-	B	e3
R 4034	CHIP RES.	6.8k	1/16W	5%	RMC1/16 682JATP	J24185682		1-	A	C3
R 4035	CHIP RES.	6.8k	1/16W	5%	RMC1/16 682JATP	J24185682		1-	A	C2
R 4036	CHIP RES.	47k	1/16W	5%	RMC1/16 473JATP	J24185473		1-	B	f3
R 4037	CHIP RES.	4.7k	1/16W	5%	RMC1/16 472JATP	J24185472		1-	B	f4
R 4038	CHIP RES.	200	1/16W	1%	RMC1/16 201FTP	J24183201		1-	A	C3
R 4039	CHIP RES.	200	1/16W	1%	RMC1/16 201FTP	J24183201		1-	A	C2
R 4040	CHIP RES.	470	1/16W	5%	RMC1/16 471JATP	J24185471	W/OCXO	1-	B	f6
R 4041	CHIP RES.	100	1/16W	5%	RMC1/16 101JATP	J24185101		1-	A	E3
R 4042	CHIP RES.	47k	1/16W	5%	RMC1/16 473JATP	J24185473		1-	B	e3
R 4043	CHIP RES.	3.3k	1/16W	5%	RMC1/16 332JATP	J24185332		1-	B	e3
R 4044	CHIP RES.	1k	1/16W	5%	RMC1/16 102JATP	J24185102		1-	B	f3
R 4045	CHIP RES.	1k	1/16W	5%	RMC1/16 102JATP	J24185102		1-	B	e3
R 4046	CHIP RES.	100	1/16W	5%	RMC1/16 101JATP	J24185101		1-	A	C3
R 4047	CHIP RES.	100	1/16W	5%	RMC1/16 101JATP	J24185101		1-	A	C2
R 4048	CHIP RES.	47	1/16W	5%	RMC1/16 470JATP	J24185470	W/OCXO	1-	A	D6
R 4049	CHIP RES.	100	1/16W	5%	RMC1/16 101JATP	J24185101		1-	A	C3
R 4050	CHIP RES.	100	1/16W	5%	RMC1/16 101JATP	J24185101		1-	A	C2
R 4051	CHIP RES.	100	1/16W	5%	RMC1/16 101JATP	J24185101		1-	A	C3
R 4052	CHIP RES.	100	1/16W	5%	RMC1/16 101JATP	J24185101		1-	A	C2
R 4053	CHIP RES.	100k	1/16W	5%	RMC1/16 104JATP	J24185104		1-	B	e4
R 4054	CHIP RES.	4.7k	1/16W	5%	RMC1/16 472JATP	J24185472		1-	A	D2
R 4055	CHIP RES.	220	1/16W	5%	RMC1/16 221JATP	J24185221		1-	B	e4
R 4056	CHIP RES.	10k	1/16W	5%	RMC1/16 103JATP	J24185103	W/TCXO	1-	B	g5
R 4057	CHIP RES.	220	1/16W	5%	RMC1/16 221JATP	J24185221		1-	B	e4
R 4058	CHIP RES.	220	1/16W	5%	RMC1/16 221JATP	J24185221		1-	B	e4
R 4059	CHIP RES.	0	1/16W	5%	RMC1/16 000JATP	J24185000	W/OCXO	1-	B	h5
R 4060	CHIP RES.	0	1/16W	5%	RMC1/16 000JATP	J24185000	W/TCXO	1-	B	h5
R 4061	CHIP RES.	220	1/16W	5%	RMC1/16 221JATP	J24185221		1-	A	F2
R 4062	CHIP RES.	220k	1/16W	5%	RMC1/16 224JATP	J24185224		1-	A	D4
R 4063	CHIP RES.	6.8k	1/16W	5%	RMC1/16 682JATP	J24185682	W/OCXO	1-	B	f5

LOCAL Unit

Parts List

REF	DESCRIPTION	VALUE	V/W	TOL.	MFR'S DESIG	VXSTD P/N	VERS.	LOT	SIDE	LAY ADR
R 4064	CHIP RES.	47	1/16W	5%	RMC1/16 470JATP	J24185470		1-	A	D4
R 4065	CHIP RES.	1k	1/16W	5%	RMC1/16 102JATP	J24185102		1-	A	D4
R 4066	CHIP RES.	22k	1/16W	5%	RMC1/16 223JATP	J24185223	W/OCXO	1-	B	f5
R 4067	CHIP RES.	220	1/16W	5%	RMC1/16 221JATP	J24185221		1-	A	C3
R 4068	CHIP RES.	47	1/16W	5%	RMC1/16 470JATP	J24185470		1-	A	C4
R 4069	CHIP RES.	220	1/16W	5%	RMC1/16 221JATP	J24185221		1-	A	C2
R 4070	CHIP RES.	47	1/16W	5%	RMC1/16 470JATP	J24185470		1-	A	C3
R 4071	CHIP RES.	100k	1/16W	5%	RMC1/16 104JATP	J24185104		1-	A	C3
R 4072	CHIP RES.	100k	1/16W	5%	RMC1/16 104JATP	J24185104		1-	A	C2
R 4073	CHIP RES.	470	1/16W	5%	RMC1/16 471JATP	J24185471		1-	A	D4
R 4074	CHIP RES.	47	1/16W	5%	RMC1/16 470JATP	J24185470		1-	A	E4
R 4075	CHIP RES.	1k	1/16W	5%	RMC1/16 102JATP	J24185102	W/OCXO	1-	B	f5
R 4076	CHIP RES.	33k	1/16W	5%	RMC1/16 333JATP	J24185333		1-	A	C3
R 4077	CHIP RES.	33k	1/16W	5%	RMC1/16 333JATP	J24185333		1-	A	C2
R 4078	CHIP RES.	47k	1/16W	5%	RMC1/16 473JATP	J24185473		1-	A	D2
R 4079	CHIP RES.	330	1/16W	5%	RMC1/16 331JATP	J24185331		1-	A	E4
R 4080	CHIP RES.	47	1/16W	5%	RMC1/16 470JATP	J24185470	W/OCXO	1-	A	D5
R 4081	CHIP RES.	47k	1/16W	5%	RMC1/16 473JATP	J24185473		1-	A	D2
R 4082	CHIP RES.	150	1/16W	5%	RMC1/16 151JATP	J24185151		1-	A	E2
R 4083	CHIP RES.	33k	1/16W	5%	RMC1/16 333JATP	J24185333		1-	A	D4
R 4084	CHIP RES.	100	1/16W	5%	RMC1/16 101JATP	J24185101		1-	A	F3
R 4085	CHIP RES.	100	1/16W	5%	RMC1/16 101JATP	J24185101		1-	A	H4
R 4086	CHIP RES.	100	1/16W	5%	RMC1/16 101JATP	J24185101		1-	A	F4
R 4087	CHIP RES.	100	1/16W	5%	RMC1/16 101JATP	J24185101		1-	A	G3
R 4088	CHIP RES.	47	1/16W	5%	RMC1/16 470JATP	J24185470		1-	A	H4
R 4089	CHIP RES.	47	1/16W	5%	RMC1/16 470JATP	J24185470		1-	A	F4
R 4090	CHIP RES.	47	1/16W	5%	RMC1/16 470JATP	J24185470		1-	A	G3
R 4091	CHIP RES.	1k	1/16W	5%	RMC1/16 102JATP	J24185102		1-	A	F4
R 4092	CHIP RES.	1k	1/16W	5%	RMC1/16 102JATP	J24185102		1-	A	F4
R 4093	CHIP RES.	1k	1/16W	5%	RMC1/16 102JATP	J24185102		1-	A	F4
R 4094	CHIP RES.	1k	1/16W	5%	RMC1/16 102JATP	J24185102		1-	A	G2
R 4095	CHIP RES.	1k	1/16W	5%	RMC1/16 102JATP	J24185102		1-	A	G2
R 4096	CHIP RES.	1k	1/16W	5%	RMC1/16 102JATP	J24185102		1-	A	G2
R 4097	CHIP RES.	1k	1/16W	5%	RMC1/16 102JATP	J24185102		1-	A	H4
R 4098	CHIP RES.	1k	1/16W	5%	RMC1/16 102JATP	J24185102		1-	A	H4
R 4099	CHIP RES.	1k	1/16W	5%	RMC1/16 102JATP	J24185102		1-	A	H4
R 4100	CHIP RES.	10k	1/16W	5%	RMC1/16 103JATP	J24185103		1-	A	H5
R 4101	CHIP RES.	10k	1/16W	5%	RMC1/16 103JATP	J24185103		1-	A	F5
R 4102	CHIP RES.	10k	1/16W	5%	RMC1/16 103JATP	J24185103		1-	A	G2
R 4103	CHIP RES.	1k	1/16W	5%	RMC1/16 102JATP	J24185102		1-	A	H4
R 4104	CHIP RES.	1k	1/16W	5%	RMC1/16 102JATP	J24185102		1-	A	F4
R 4105	CHIP RES.	1k	1/16W	5%	RMC1/16 102JATP	J24185102		1-	A	G3
R 4106	CHIP RES.	1k	1/16W	5%	RMC1/16 102JATP	J24185102		1-	A	H4
R 4107	CHIP RES.	1k	1/16W	5%	RMC1/16 102JATP	J24185102		1-	A	F4
R 4108	CHIP RES.	1k	1/16W	5%	RMC1/16 102JATP	J24185102		1-	A	H3
R 4109	CHIP RES.	3.9k	1/16W	5%	RMC1/16 392JATP	J24185392		1-	A	G4
R 4110	CHIP RES.	3.9k	1/16W	5%	RMC1/16 392JATP	J24185392		1-	A	F4
R 4111	CHIP RES.	3.9k	1/16W	5%	RMC1/16 392JATP	J24185392		1-	A	H2
R 4112	CHIP RES.	100	1/16W	1%	RMC1/16 101FTP	J24183101		1-	A	G4
R 4113	CHIP RES.	100	1/16W	1%	RMC1/16 101FTP	J24183101		1-	A	F4
R 4114	CHIP RES.	100	1/16W	1%	RMC1/16 101FTP	J24183101		1-	A	H2
R 4115	CHIP RES.	220	1/16W	5%	RMC1/16 221JATP	J24185221		1-	A	F4
R 4116	CHIP RES.	220	1/16W	5%	RMC1/16 221JATP	J24185221		1-	A	H3
R 4117	CHIP RES.	100	1/16W	1%	RMC1/16 101FTP	J24183101		1-	A	G4
R 4118	CHIP RES.	100	1/16W	1%	RMC1/16 101FTP	J24183101		1-	A	E4
R 4119	CHIP RES.	100	1/16W	1%	RMC1/16 101FTP	J24183101		1-	A	H2
R 4120	CHIP RES.	47k	1/16W	5%	RMC1/16 473JATP	J24185473		1-	B	b6
R 4121	CHIP RES.	47k	1/16W	5%	RMC1/16 473JATP	J24185473		1-	B	b6
R 4122	CHIP RES.	47k	1/16W	5%	RMC1/16 473JATP	J24185473		1-	B	c5
R 4123	CHIP RES.	47k	1/16W	5%	RMC1/16 473JATP	J24185473		1-	B	d5
R 4124	CHIP RES.	47k	1/16W	5%	RMC1/16 473JATP	J24185473		1-	B	b2
R 4125	CHIP RES.	47k	1/16W	5%	RMC1/16 473JATP	J24185473		1-	B	b2
R 4126	CHIP RES.	47k	1/16W	5%	RMC1/16 473JATP	J24185473		1-	B	d5
R 4127	CHIP RES.	47k	1/16W	5%	RMC1/16 473JATP	J24185473		1-	B	d5
R 4128	CHIP RES.	47k	1/16W	5%	RMC1/16 473JATP	J24185473		1-	B	b2
R 4129	CHIP RES.	47k	1/16W	5%	RMC1/16 473JATP	J24185473		1-	B	b2
R 4130	CHIP RES.	47k	1/16W	5%	RMC1/16 473JATP	J24185473		1-	B	b5
R 4131	CHIP RES.	47k	1/16W	5%	RMC1/16 473JATP	J24185473		1-	B	b5
R 4132	CHIP RES.	47k	1/16W	5%	RMC1/16 473JATP	J24185473		1-	B	b6
R 4133	CHIP RES.	10k	1/16W	5%	RMC1/16 103JATP	J24185103		1-	B	b5
R 4134	CHIP RES.	47k	1/16W	5%	RMC1/16 473JATP	J24185473		1-	B	b6
R 4135	CHIP RES.	47k	1/16W	5%	RMC1/16 473JATP	J24185473		1-	B	b5
R 4136	CHIP RES.	47k	1/16W	5%	RMC1/16 473JATP	J24185473		1-	B	b5

LOCAL Unit

Parts List

REF	DESCRIPTION	VALUE	V/W	TOL.	MFR'S DESIG	VXSTD P/N	VERS.	LOT	SIDE	LAY ADR
R 4137	CHIP RES.	47k	1/16W	5%	RMC1/16 473JATP	J24185473		1-	B	c6
R 4142	CHIP RES.	47k	1/16W	5%	RMC1/16 473JATP	J24185473		1-	B	d5
R 4143	CHIP RES.	47k	1/16W	5%	RMC1/16 473JATP	J24185473		1-	B	d5
R 4144	CHIP RES.	47k	1/16W	5%	RMC1/16 473JATP	J24185473		1-	B	b2
R 4145	CHIP RES.	47k	1/16W	5%	RMC1/16 473JATP	J24185473		1-	B	b2
R 4146	CHIP RES.	47k	1/16W	5%	RMC1/16 473JATP	J24185473		1-	B	d5
R 4147	CHIP RES.	47k	1/16W	5%	RMC1/16 473JATP	J24185473		1-	B	d5
R 4148	CHIP RES.	47k	1/16W	5%	RMC1/16 473JATP	J24185473		1-	B	b2
R 4149	CHIP RES.	47k	1/16W	5%	RMC1/16 473JATP	J24185473		1-	B	b2
R 4150	CHIP RES.	4.7k	1/16W	5%	RMC1/16 472JATP	J24185472		1-	B	b5
R 4151	CHIP RES.	4.7k	1/16W	5%	RMC1/16 472JATP	J24185472		1-	B	b5
R 4152	CHIP RES.	4.7k	1/16W	5%	RMC1/16 472JATP	J24185472		1-	B	b5
R 4153	CHIP RES.	4.7k	1/16W	5%	RMC1/16 472JATP	J24185472		1-	B	b5
R 4154	CHIP RES.	22	1/16W	5%	RMC1/16 220JATP	J24185220		1-	B	b5
R 4155	CHIP RES.	100	1/16W	5%	RMC1/16 101JATP	J24185101		1-	B	b5
R 4156	CHIP RES.	220	1/16W	5%	RMC1/16 221JATP	J24185221		1-	B	d5
R 4157	CHIP RES.	220	1/16W	5%	RMC1/16 221JATP	J24185221		1-	B	a2
R 4158	CHIP RES.	220	1/16W	5%	RMC1/16 221JATP	J24185221		1-	B	d5
R 4159	CHIP RES.	220	1/16W	5%	RMC1/16 221JATP	J24185221		1-	B	a2
R 4160	CHIP RES.	10k	1/16W	5%	RMC1/16 103JATP	J24185103		1-	A	F5
R 4161	CHIP RES.	10k	1/16W	5%	RMC1/16 103JATP	J24185103		1-	A	G2
R 4162	CHIP RES.	220	1/16W	5%	RMC1/16 221JATP	J24185221		1-	A	G5
R 4163	CHIP RES.	4.7k	1/16W	5%	RMC1/16 472JATP	J24185472		1-	B	d5
R 4164	CHIP RES.	4.7k	1/16W	5%	RMC1/16 472JATP	J24185472		1-	B	d5
R 4165	CHIP RES.	4.7k	1/16W	5%	RMC1/16 472JATP	J24185472		1-	B	d5
R 4166	CHIP RES.	4.7k	1/16W	5%	RMC1/16 472JATP	J24185472		1-	B	d5
R 4167	CHIP RES.	4.7k	1/16W	5%	RMC1/16 472JATP	J24185472		1-	B	b1
R 4168	CHIP RES.	4.7k	1/16W	5%	RMC1/16 472JATP	J24185472		1-	B	a2
R 4169	CHIP RES.	4.7k	1/16W	5%	RMC1/16 472JATP	J24185472		1-	B	a2
R 4170	CHIP RES.	4.7k	1/16W	5%	RMC1/16 472JATP	J24185472		1-	B	a2
R 4171	CHIP RES.	47k	1/16W	5%	RMC1/16 473JATP	J24185473		1-	B	c5
R 4172	CHIP RES.	47k	1/16W	5%	RMC1/16 473JATP	J24185473		1-	B	b2
R 4173	CHIP RES.	220	1/16W	5%	RMC1/16 221JATP	J24185221		1-	A	G5
R 4174	CHIP RES.	27	1/16W	5%	RMC1/16 270JATP	J24185270		1-	A	G5
R 4175	CHIP RES.	33	1/16W	5%	RMC1/16 330JATP	J24185330		1-	A	G5
R 4176	CHIP RES.	27	1/16W	5%	RMC1/16 270JATP	J24185270		1-	A	G5
R 4177	CHIP RES.	100	1/16W	5%	RMC1/16 101JATP	J24185101		1-	A	G5
R 4178	CHIP RES.	100	1/16W	5%	RMC1/16 101JATP	J24185101		1-	A	G5
R 4179	CHIP RES.	220	1/16W	5%	RMC1/16 221JATP	J24185221		1-	A	H5
R 4180	CHIP RES.	100	1/16W	5%	RMC1/16 101JATP	J24185101		1-	B	d5
R 4181	CHIP RES.	100	1/16W	5%	RMC1/16 101JATP	J24185101		1-	B	b1
R 4182	CHIP RES.	22	1/16W	5%	RMC1/16 220JATP	J24185220		1-	B	d5
R 4183	CHIP RES.	68	1/16W	5%	RMC1/16 680JATP	J24185680		1-	B	d5
R 4184	CHIP RES.	22	1/16W	5%	RMC1/16 220JATP	J24185220		1-	B	b1
R 4185	CHIP RES.	68	1/16W	5%	RMC1/16 680JATP	J24185680		1-	B	a2
R 4186	CHIP RES.	220	1/16W	5%	RMC1/16 221JATP	J24185221		1-	A	E5
R 4187	CHIP RES.	220	1/16W	5%	RMC1/16 221JATP	J24185221		1-	A	H2
R 4188	CHIP RES.	100	1/16W	5%	RMC1/16 101JATP	J24185101		1-	A	H5
R 4189	CHIP RES.	27	1/16W	5%	RMC1/16 270JATP	J24185270		1-	A	E5
R 4190	CHIP RES.	27	1/16W	5%	RMC1/16 270JATP	J24185270		1-	A	H2
R 4191	CHIP RES.	220	1/16W	5%	RMC1/16 221JATP	J24185221		1-	A	H5
R 4192	CHIP RES.	33	1/16W	5%	RMC1/16 330JATP	J24185330		1-	A	E5
R 4193	CHIP RES.	33	1/16W	5%	RMC1/16 330JATP	J24185330		1-	A	H2
R 4195	CHIP RES.	27	1/16W	5%	RMC1/16 270JATP	J24185270		1-	A	E5
R 4196	CHIP RES.	27	1/16W	5%	RMC1/16 270JATP	J24185270		1-	A	H2
R 4197	CHIP RES.	220	1/16W	5%	RMC1/16 221JATP	J24185221		1-	A	F5
R 4198	CHIP RES.	220	1/16W	5%	RMC1/16 221JATP	J24185221		1-	A	H1
R 4199	CHIP RES.	220	1/16W	5%	RMC1/16 221JATP	J24185221		1-	A	H6
R 4200	CHIP RES.	220	1/16W	5%	RMC1/16 221JATP	J24185221		1-	A	H6
R 4201	CHIP RES.	220	1/16W	5%	RMC1/16 221JATP	J24185221		1-	B	d5
R 4202	CHIP RES.	220	1/16W	5%	RMC1/16 221JATP	J24185221		1-	B	a2
R 4203	CHIP RES.	0	1/16W	5%	RMC1/16 000JATP	J24185000		1-	B	a6
R 4204	CHIP RES.	0	1/16W	5%	RMC1/16 000JATP	J24185000		1-	B	d6
R 4205	CHIP RES.	0	1/16W	5%	RMC1/16 000JATP	J24185000		1-	B	b1
R 4206	CHIP RES.	2.2k	1/16W	5%	RMC1/16 222JATP	J24185222		1-	B	a4
R 4207	CHIP RES.	3.3k	1/16W	5%	RMC1/16 332JATP	J24185332		1-	B	a4
R 4208	CHIP RES.	2.2k	1/16W	5%	RMC1/16 222JATP	J24185222		1-	B	c4
R 4209	CHIP RES.	3.3k	1/16W	5%	RMC1/16 332JATP	J24185332		1-	B	c4
R 4210	CHIP RES.	2.2k	1/16W	5%	RMC1/16 222JATP	J24185222		1-	B	b3
R 4211	CHIP RES.	3.3k	1/16W	5%	RMC1/16 332JATP	J24185332		1-	B	b3
T 4001	BALUN TRANSFORMERS				#617DS-1710	L0190275		1-	A	C4
T 4002	COIL 07RF	9MHz			070812754D 9.0M	L0023053		1-	A	B3
T 4003	COIL 05RF				74.62M 010812302	L0022781	W/OXCO	1-	A	D6

LOCAL Unit

Parts List

REF	DESCRIPTION	VALUE	V/W	TOL.	MFR'S DESIG	VXSTD P/N	VERS.	LOT	SIDE	LAY ADR
T 4004	COIL 05RF				74.62M 010812302	L0022781	W/OCXO	1-	A	D5
T 4005	BALUN TRANSFOMERS				#617DS-1710	L0190275		1-	A	F3
T 4006	COIL 05RF				74.62M 010812302	L0022781	W/OCXO	1-	A	D5
T 4007	BALUN TRANSFOMERS				#458PT-1565	L0190273		1-	A	G4
T 4008	BALUN TRANSFOMERS				#458PT-1565	L0190273		1-	A	E4
T 4009	BALUN TRANSFOMERS				#458PT-1565	L0190273		1-	A	H3
T 4010	BALUN TRANSFOMERS				#458PT-1565	L0190273		1-	A	H5
T 4011	BALUN TRANSFOMERS				#458PT-1565	L0190273		1-	A	F5
T 4012	BALUN TRANSFOMERS				#458PT-1565	L0190273		1-	A	H1
X 4001	OCVCXO	10MHz			185H	H9501200	W/OCXO	1-	A	C5
X 4002	TCXO	40MHz			TTS18VSH 40.00000MHZ	H9501260	W/TCXO	1-	B	g5
	SHIELD CASE				(33X47)	RA0830500		1-		
	SHIELD CASE COVER				(33X47)	RA0830600		1-		

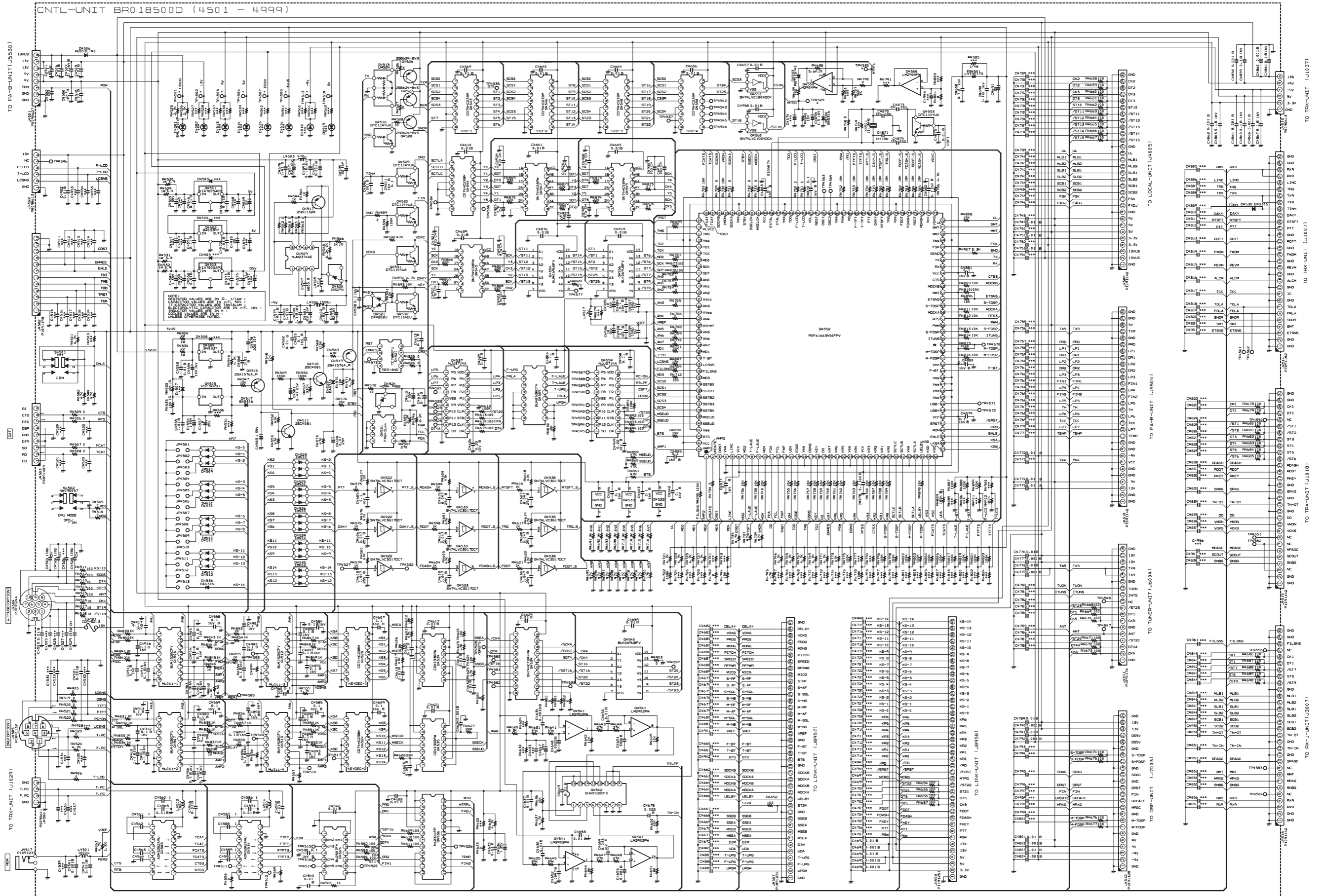

CNTL Unit (Lot. 1 ~ 7)

Note

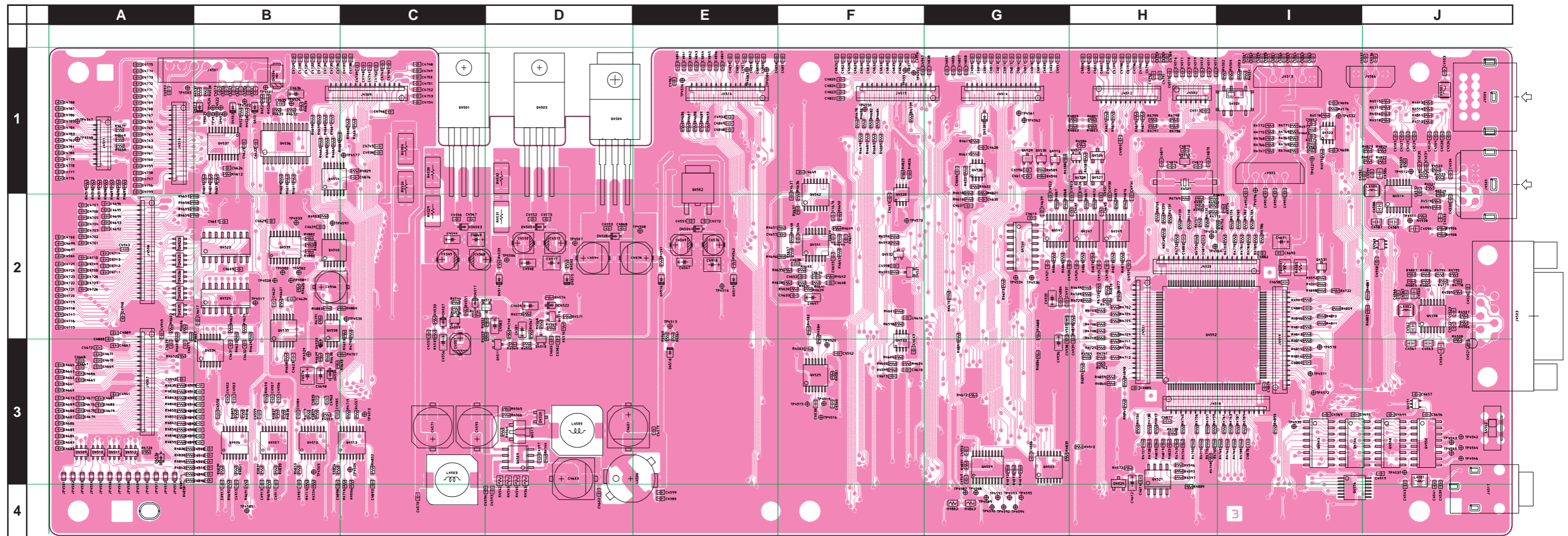

CNTL Unit (Lot. 1 ~ 7)

Parts Layout (Side B)

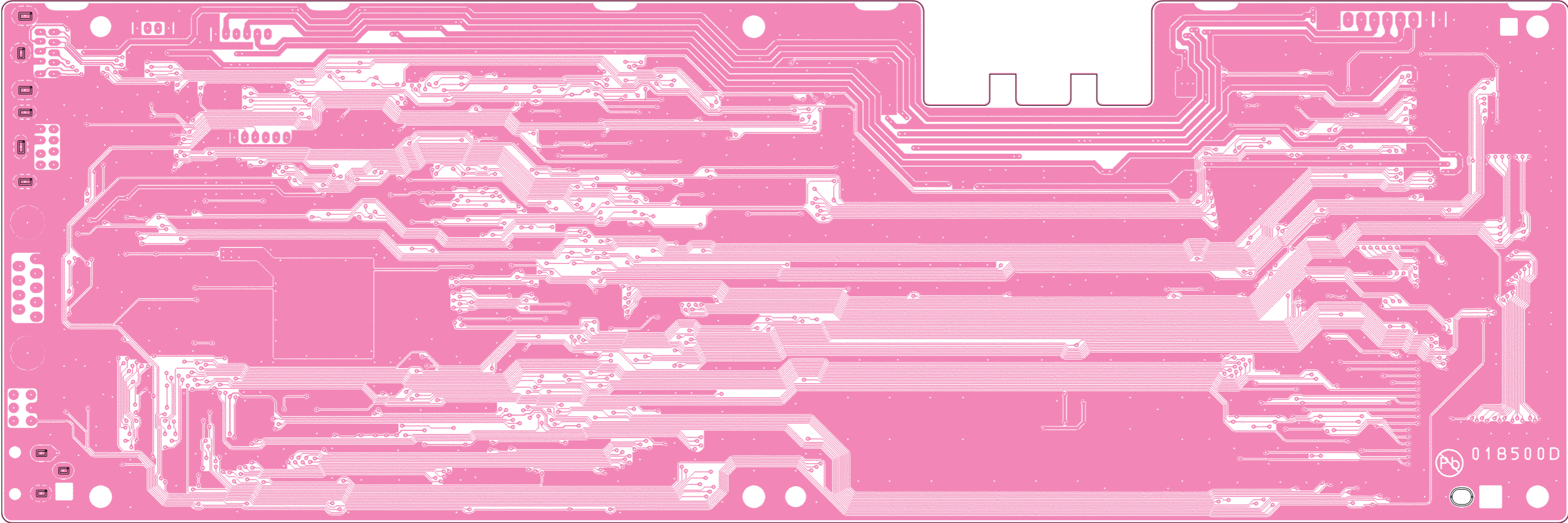

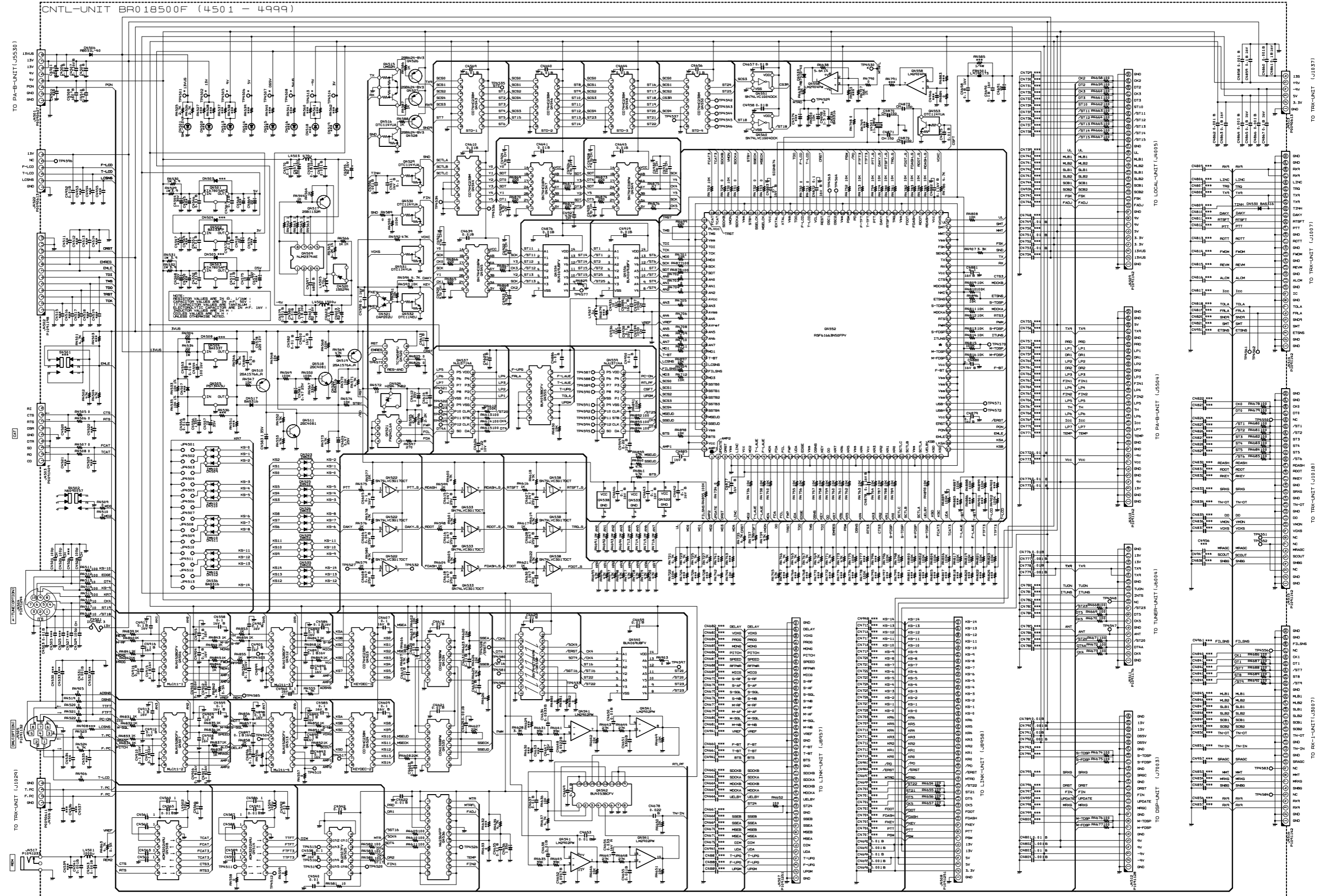

CNTL Unit (Lot. 8 ~)

Note

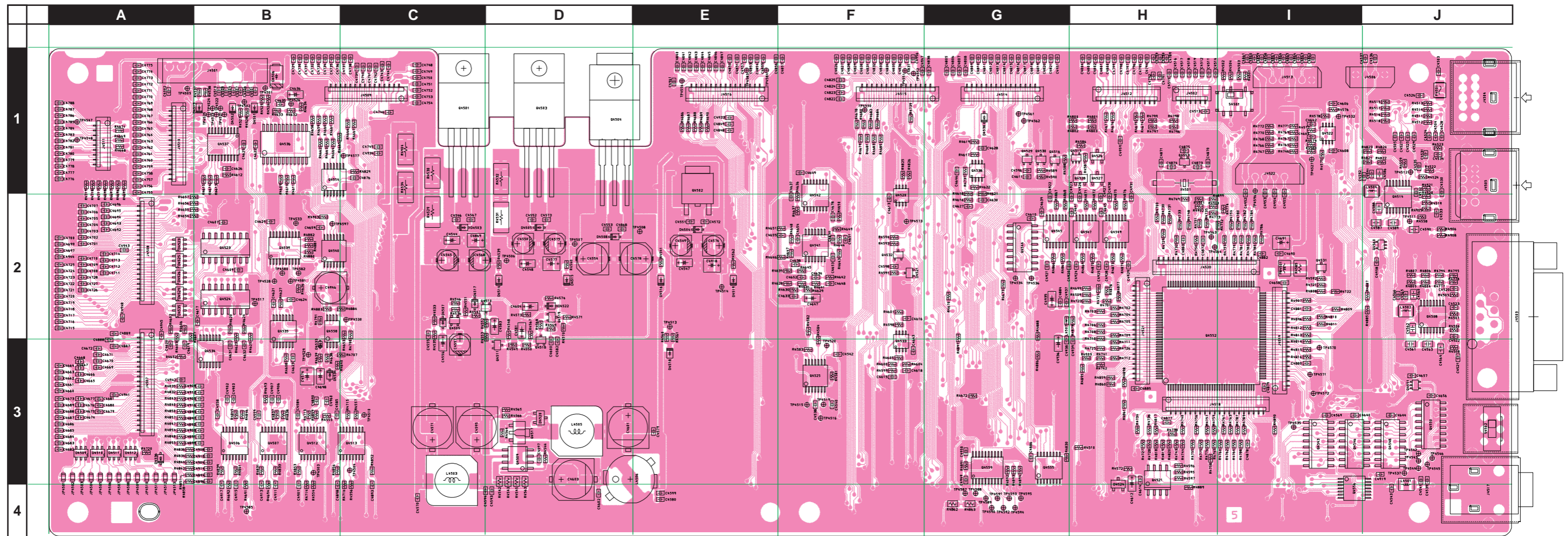

CNTL Unit (Lot. 8 ~)

Parts Layout (Side B)

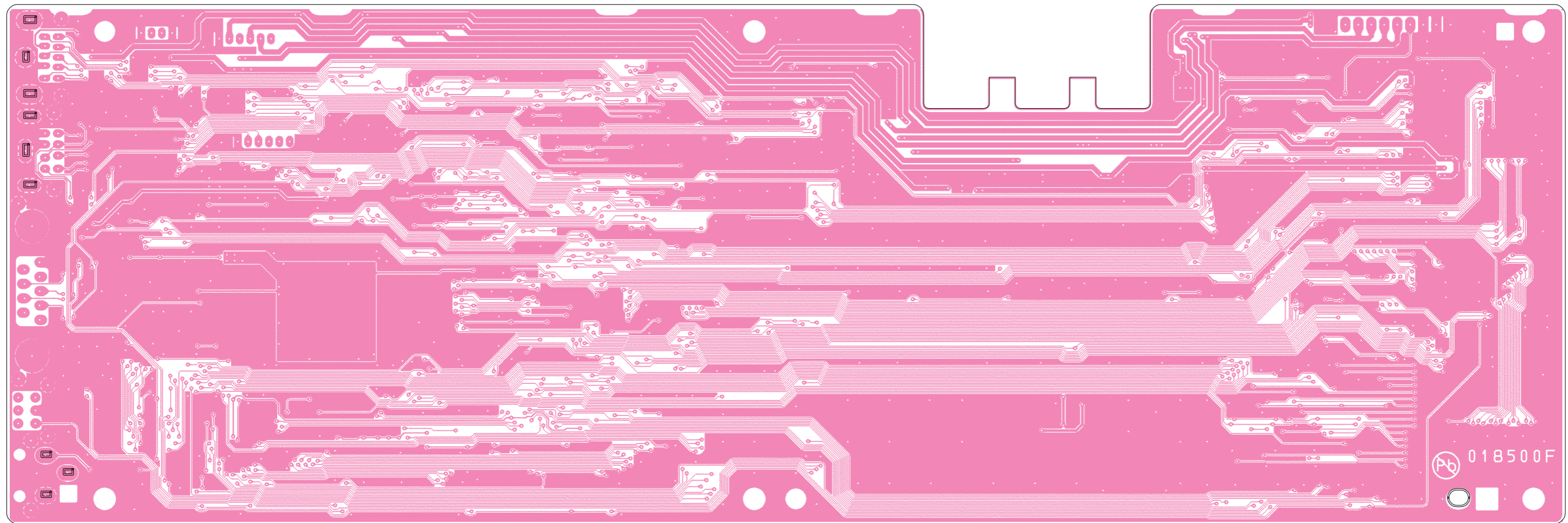

REF	DESCRIPTION	VALUE	V/W	TOL.	MFR'S DESIG	VXSTD P/N	VERS.	LOT	SIDE	LAY ADR
	PCB with Components					CS2075701	USA			
	PCB with Components					CS2075703	EXPORT			
	PCB with Components					CS2075704	EUROPE			
	PCB with Components					CS2075705	UNITED KINGDOM			
	PCB with Components					CS2075706	FRANCE			
	PCB with Components					CS2075707	AUSTRALIA			
	Printed Circuit Board					FR018500D		1-12		
	Printed Circuit Board					FR018500D	W/O CE LABEL	6-12		
	Printed Circuit Board					FR018500F	W/ CE LABEL	8-12		
	Printed Circuit Board					FR018500F		13-		
C 4501	CHIP CAP.	0.1uF	16V	B	GRM188B11C104KA01D	K22124805		1-	A	B1
C 4503	CHIP CAP.	0.01uF	50V	B	GRM188B11H103KA01D	K22174823		1-	A	J1
C 4504	CHIP CAP.	100pF	50V	CH	GRM1882C1H101JA01D	K22174235		1-	A	J1
C 4506	CHIP CAP.	0.01uF	50V	B	GRM188B11H103KA01D	K22174823		1-	A	B1
C 4507	CHIP CAP.	0.1uF	16V	B	GRM188B11C104KA01D	K22124805		1-	A	B1
C 4508	CHIP CAP.	0.1uF	16V	B	GRM188B11C104KA01D	K22124805		1-	A	B1
C 4509	CHIP CAP.	0.01uF	50V	B	GRM188B11H103KA01D	K22174823		1-	A	B1
C 4510	CHIP CAP.	0.01uF	50V	B	GRM188B11H103KA01D	K22174823		1-	A	B1
C 4524	CHIP CAP.	100pF	50V	CH	GRM1882C1H101JA01D	K22174235		1-	A	J1
C 4528	CHIP CAP.	100pF	50V	CH	GRM1882C1H101JA01D	K22174235		1-	A	J1
C 4529	CHIP CAP.	100pF	50V	CH	GRM1882C1H101JA01D	K22174235		1-	A	J1
C 4531	CHIP CAP.	0.001uF	50V	B	GRM188B11H102KA01D	K22174821		1-	A	J1
C 4538	CHIP CAP.	0.1uF	16V	B	GRM188B11C104KA01D	K22124805		1-	A	F3
C 4540	CHIP CAP.	0.01uF	50V	B	GRM188B11H103KA01D	K22174823		1-	A	F3
C 4541	CHIP CAP.	0.001uF	50V	B	GRM188B11H102KA01D	K22174821		1-	A	J3
C 4542	CHIP CAP.	0.01uF	50V	B	GRM188B11H103KA01D	K22174823		1-	A	F3
C 4543	CHIP CAP.	0.001uF	50V	B	GRM188B11H102KA01D	K22174821		1-	A	J4
C 4544	CHIP TA.CAP.	1uF	35V		TEESVA1V105M8R	K78160032		1-	A	C2
C 4546	CHIP CAP.	0.01uF	50V	B	GRM188B11H103KA01D	K22174823		1-	A	C2
C 4548	CHIP TA.CAP.	1uF	35V		TEESVA1V105M8R	K78160032		1-	A	D2
C 4551	CHIP CAP.	0.01uF	50V	B	GRM188B11H103KA01D	K22174823		1-	A	E2
C 4552	CHIP CAP.	0.01uF	50V	B	GRM188B11H103KA01D	K22174823		1-	A	D2
C 4553	CHIP CAP.	0.01uF	50V	B	GRM188B11H103KA01D	K22174823		1-	A	D2
C 4554	AL.ELECTRO.CAP.	100uF	16V		EEE1CA101WP	K48120012		1-	A	D2
C 4555	CHIP CAP.	0.01uF	50V	B	GRM188B11H103KA01D	K22174823		1-	A	C2
C 4556	CHIP TA.CAP.	1uF	35V		TEESVA1V105M8R	K78160032		1-	A	C3
C 4557	AL.ELECTRO.CAP.	10uF	35V		EEE1VA100WR	K48160006		1-	A	C3
C 4558	CHIP CAP.	0.1uF	16V	B	GRM188B11C104KA01D	K22124805		1-	A	B3
C 4559	CHIP CAP.	0.1uF	16V	B	GRM188B11C104KA01D	K22124805		1-	A	B3
C 4560	CHIP CAP.	1uF	16V	B	GRM21BB11C105KA01L	K22120809		1-	A	J2
C 4561	CHIP CAP.	1uF	16V	B	GRM21BB11C105KA01L	K22120809		1-	A	J3
C 4562	CHIP CAP.	1uF	16V	B	GRM21BB11C105KA01L	K22120809		1-	A	J2
C 4563	CHIP CAP.	1uF	16V	B	GRM21BB11C105KA01L	K22120809		1-	A	J3
C 4564	CHIP CAP.	1uF	16V	B	GRM21BB11C105KA01L	K22120809		1-	A	J3
C 4565	CHIP CAP.	0.01uF	50V	B	GRM188B11H103KA01D	K22174823		1-	A	J2
C 4566	CHIP CAP.	0.01uF	50V	B	GRM188B11H103KA01D	K22174823		1-	A	J2
C 4567	CHIP CAP.	0.01uF	50V	B	GRM188B11H103KA01D	K22174823		1-	A	C2
C 4569	CHIP CAP.	0.01uF	50V	B	GRM188B11H103KA01D	K22174823		1-	A	I3
C 4570	CHIP CAP.	0.01uF	50V	B	GRM188B11H103KA01D	K22174823		1-	A	C4
C 4571	AL.ELECTRO.CAP.	82uF	16V		APXA160ARA820MH70G	K48120022		1-	A	C3
C 4572	CHIP CAP.	0.01uF	50V	B	GRM188B11H103KA01D	K22174823		1-	A	E2
C 4573	CHIP CAP.	0.01uF	50V	B	GRM188B11H103KA01D	K22174823		1-	A	D2
C 4575	AL.ELECTRO.CAP.	10uF	35V		EEE1VA100WR	K48160006		1-	A	D2
C 4578	AL.ELECTRO.CAP.	220uF	10V		EEE1AA221XP	K48100007		1-	A	E2
C 4579	CHIP CAP.	0.001uF	50V	B	GRM188B11H102KA01D	K22174821		1-	A	E3
C 4580	CHIP CAP.	0.01uF	50V	B	GRM188B11H103KA01D	K22174823		1-	A	E4
C 4581	CHIP TA.CAP.	0.47uF	25V		TEESVA1E474M8R	K78140009		1-	A	D2
C 4582	CHIP CAP.	0.01uF	50V	B	GRM188B11H103KA01D	K22174823		1-	A	D3
C 4583	CHIP TA.CAP.	1uF	35V		TEESVA1V105M8R	K78160032		1-	A	D2
C 4584	CHIP CAP.	0.1uF	16V	B	GRM188B11C104KA01D	K22124805		1-	A	B3
C 4585	CHIP CAP.	0.1uF	16V	B	GRM188B11C104KA01D	K22124805		1-	A	B3
C 4586	CHIP CAP.	1uF	16V	B	GRM21BB11C105KA01L	K22120809		1-	A	J1
C 4587	CHIP CAP.	1uF	16V	B	GRM21BB11C105KA01L	K22120809		1-	A	J2
C 4588	CHIP CAP.	1uF	16V	B	GRM21BB11C105KA01L	K22120809		1-	A	J2
C 4589	CHIP CAP.	1uF	16V	B	GRM21BB11C105KA01L	K22120809		1-	A	J2
C 4590	CHIP CAP.	1uF	16V	B	GRM21BB11C105KA01L	K22120809		1-	A	J2
C 4591	CHIP CAP.	0.01uF	50V	B	GRM188B11H103KA01D	K22174823		1-	A	J1
C 4592	CHIP CAP.	0.01uF	50V	B	GRM188B11H103KA01D	K22174823		1-	A	I1
C 4593	CHIP CAP.	0.1uF	16V	B	GRM188B11C104KA01D	K22124805		1-	A	D4
C 4594	CHIP CAP.	0.001uF	50V	B	GRM188B11H102KA01D	K22174821		1-	A	C4
C 4595	AL.ELECTRO.CAP.	82uF	16V		APXA160ARA820MH70G	K48120022		1-	A	C3
C 4596	CHIP CAP.	0.001uF	50V	B	GRM188B11H102KA01D	K22174821		1-	A	G1
C 4597	CHIP CAP.	680pF	50V	B	GRM188B11H681KA01D	K22174807		1-	A	D3

CNTL Unit

Parts List

REF	DESCRIPTION	VALUE	V/W	TOL.	MFR'S DESIG	VXSTD P/N	VERS.	LOT	SIDE	LAY ADR
C 4598	CHIP CAP.	0.1uF	16V	B	GRM188B11C104KA01D	K22124805		1-	A	F2
C 4599	CHIP CAP.	0.1uF	16V	B	GRM188B11C104KA01D	K22124805		1-	A	E4
C 4600	CHIP CAP.	0.1uF	16V	B	GRM188B11C104KA01D	K22124805		1-	A	D3
C 4601	AL.ELECTRO.CAP.	82uF	16V		APXA160ARA820MH70G	K48120022		1-	A	D3
C 4602	CHIP CAP.	0.01uF	50V	B	GRM188B11H103KA01D	K22174823		1-	A	D4
C 4603	AL.ELECTRO.CAP.	82uF	16V		APXA160ARA820MH70G	K48120022		1-	A	D3
C 4604	CHIP TA.CAP.	0.47uF	25V		TEESVA1E474M8R	K78140009		1-	A	D2
C 4605	CHIP CAP.	0.1uF	16V	B	GRM188B11C104KA01D	K22124805		1-	A	I1
C 4606	CHIP CAP.	0.1uF	16V	B	GRM188B11C104KA01D	K22124805		1	A	I1
C 4606	CHIP CAP.	0.047uF	25V	B	GRM188B11E473KA01D	K22144811		2-	A	I1
C 4607	CHIP CAP.	0.1uF	16V	B	GRM188B11C104KA01D	K22124805		1-	A	B2
C 4608	CHIP CAP.	0.1uF	16V	B	GRM188B11C104KA01D	K22124805		1	A	I1
C 4608	CHIP CAP.	0.047uF	25V	B	GRM188B11E473KA01D	K22144811		2-	A	I1
C 4609	CHIP CAP.	0.1uF	16V	B	GRM188B11C104KA01D	K22124805		1-	A	B2
C 4610	CHIP CAP.	0.01uF	50V	B	GRM188B11H103KA01D	K22174823		1-	A	G2
C 4611	CHIP CAP.	0.1uF	16V	B	GRM188B11C104KA01D	K22124805		1-	A	G1
C 4612	CHIP TA.CAP.	1uF	35V		TEESVA1V105M8R	K78160032		1-	A	H3
C 4613	CHIP CAP.	0.01uF	50V	B	GRM188B11H103KA01D	K22174823		1-	A	F2
C 4614	CHIP CAP.	0.01uF	50V	B	GRM188B11H103KA01D	K22174823		1-	A	H3
C 4615	CHIP CAP.	0.1uF	16V	B	GRM188B11C104KA01D	K22124805		1	A	F3
C 4615	CHIP CAP.	0.047uF	25V	B	GRM188B11E473KA01D	K22144811		2-	A	F3
C 4616	CHIP CAP.	0.1uF	16V	B	GRM188B11C104KA01D	K22124805		1	A	F2
C 4616	CHIP CAP.	0.047uF	25V	B	GRM188B11E473KA01D	K22144811		2-	A	F2
C 4617	CHIP CAP.	0.01uF	50V	B	GRM188B11H103KA01D	K22174823		1-	A	B2
C 4618	CHIP CAP.	0.1uF	16V	B	GRM188B11C104KA01D	K22124805		1	A	F3
C 4618	CHIP CAP.	0.047uF	25V	B	GRM188B11E473KA01D	K22144811		2-	A	F3
C 4619	CHIP CAP.	0.01uF	50V	B	GRM188B11H103KA01D	K22174823		1-	A	A3
C 4620	CHIP CAP.	0.01uF	50V	B	GRM188B11H103KA01D	K22174823		1-	A	A3
C 4621	CHIP CAP.	0.01uF	50V	B	GRM188B11H103KA01D	K22174823		1-	A	B2
C 4622	CHIP CAP.	0.01uF	50V	B	GRM188B11H103KA01D	K22174823		1-	A	B1
C 4623	CHIP CAP.	0.001uF	50V	B	GRM188B11H102KA01D	K22174821		1-	A	B3
C 4624	CHIP CAP.	0.001uF	50V	B	GRM188B11H102KA01D	K22174821		1-	A	B2
C 4625	CHIP CAP.	0.01uF	50V	B	GRM188B11H103KA01D	K22174823		1-	A	B1
C 4626	CHIP CAP.	0.22uF	10V	B	GRM188B11A224KA01D	K22104801		1-	A	B1
C 4627	CHIP CAP.	0.1uF	16V	B	GRM188B11C104KA01D	K22124805		1	A	G2
C 4627	CHIP CAP.	0.047uF	25V	B	GRM188B11E473KA01D	K22144811		2-	A	G2
C 4628	CHIP CAP.	0.1uF	16V	B	GRM188B11C104KA01D	K22124805		1	A	G1
C 4628	CHIP CAP.	0.047uF	25V	B	GRM188B11E473KA01D	K22144811		2-	A	G1
C 4629	CHIP CAP.	0.01uF	50V	B	GRM188B11H103KA01D	K22174823		1-	A	B2
C 4630	CHIP CAP.	0.1uF	16V	B	GRM188B11C104KA01D	K22124805		1	A	G2
C 4630	CHIP CAP.	0.047uF	25V	B	GRM188B11E473KA01D	K22144811		2-	A	G2
C 4631	CHIP CAP.	0.01uF	50V	B	GRM188B11H103KA01D	K22174823		1-	A	B3
C 4632	CHIP CAP.	0.01uF	50V	B	GRM188B11H103KA01D	K22174823		1-	A	B3
C 4634	CHIP CAP.	0.0033uF	50V	B	GRM188B11H332KA01D	K22174831		1-	A	F2
C 4635	CHIP CAP.	0.01uF	50V	B	GRM188B11H103KA01D	K22174823		1-	A	B1
C 4636	CHIP TA.CAP.	1uF	35V		TEESVA1V105M8R	K78160032		1-	A	B1
C 4637	CHIP CAP.	0.01uF	50V	B	GRM188B11H103KA01D	K22174823		1-	A	F2
C 4638	CHIP CAP.	0.01uF	50V	B	GRM188B11H103KA01D	K22174823		1-	A	F2
C 4639	CHIP CAP.	0.01uF	50V	B	GRM188B11H103KA01D	K22174823		1-	A	G2
C 4640	CHIP CAP.	0.01uF	50V	B	GRM188B11H103KA01D	K22174823		1-	A	I3
C 4641	CHIP CAP.	0.01uF	50V	B	GRM188B11H103KA01D	K22174823		1-	A	G2
C 4642	CHIP CAP.	0.1uF	16V	B	GRM188B11C104KA01D	K22124805		1-	A	I1
C 4643	CHIP CAP.	0.1uF	16V	B	GRM188B11C104KA01D	K22124805		1-	A	F3
C 4644	CHIP CAP.	0.01uF	50V	B	GRM188B11H103KA01D	K22174823		1-	A	J3
C 4645	CHIP CAP.	0.01uF	50V	B	GRM188B11H103KA01D	K22174823		1-	A	H2
C 4646	CHIP CAP.	0.1uF	16V	B	GRM188B11C104KA01D	K22124805		1-	A	G1
C 4647	CHIP TA.CAP.	1uF	35V		TEESVA1V105M8R	K78160032		1-	A	F2
C 4648	CHIP CAP.	0.0022uF	50V	B	GRM188B11H222KA01D	K22174822		1-	A	F2
C 4649	CHIP CAP.	0.01uF	50V	B	GRM188B11H103KA01D	K22174823		1-	A	F1
C 4650	CHIP CAP.	0.01uF	50V	B	GRM188B11H103KA01D	K22174823		1-	A	F2
C 4651	CHIP CAP.	330pF	50V	B	GRM188B11H331KD01D	K22174803		1-	A	F2
C 4652	CHIP CAP.	0.0047uF	50V	B	GRM188B11H472KA01D	K22174833		1-	A	F2
C 4653	CHIP CAP.	0.01uF	50V	B	GRM188B11H103KA01D	K22174823		1-	A	F2
C 4654	CHIP CAP.	0.033uF	16V	R	GRM188R11C333KA01D	K22124801		1-	A	F2
C 4655	CHIP CAP.	0.001uF	50V	B	GRM188B11H102KA01D	K22174821		1-	A	F2
C 4656	CHIP CAP.	0.01uF	50V	B	GRM188B11H103KA01D	K22174823		1-	A	J3
C 4657	CHIP CAP.	0.01uF	50V	B	GRM188B11H103KA01D	K22174823		1-	A	J3
C 4658	CHIP CAP.	0.1uF	16V	B	GRM188B11C104KA01D	K22124805		1-	A	I2
C 4659	CHIP CAP.	0.01uF	50V	B	GRM188B11H103KA01D	K22174823		1-	A	B2
C 4678	CHIP CAP.	0.022uF	50V	B	GRM188B11H223KA01D	K22174839		1-	A	F2
C 4690	CHIP CAP.	0.1uF	16V	B	GRM188B11C104KA01D	K22124805		1-	A	I2
C 4691	CHIP TA.CAP.	22uF			TPSB22M016Y0600	K78120075		1-	A	I2
C 4692	CHIP CAP.	0.01uF	50V	B	GRM188B11H103KA01D	K22174823		1-	A	A2

CNTL Unit

Parts List

REF	DESCRIPTION	VALUE	V/W	TOL.	MFR'S DESIG	VXSTD P/N	VERS.	LOT	SIDE	LAY ADR
C 4693	CHIP CAP.	0.001uF	50V	B	GRM188B11H102KA01D	K22174821		1-	A	A2
C 4694	CHIP CAP.	0.01uF	50V	B	GRM188B11H103KA01D	K22174823		1-	A	A2
C 4695	CHIP CAP.	0.001uF	50V	B	GRM188B11H102KA01D	K22174821		1-	A	A2
C 4696	CHIP CAP.	0.001uF	50V	B	GRM188B11H102KA01D	K22174821		1-	A	A2
C 4698	CHIP TA.CAP.	1.5uF	16V		TEESVA1C155M8R	K78120020		1-	A	B3
C 4749	CHIP CAP.	0.01uF	50V	B	GRM188B11H103KA01D	K22174823		1-	A	C1
C 4751	CHIP CAP.	0.01uF	50V	B	GRM188B11H103KA01D	K22174823		1-	A	C1
C 4753	CHIP CAP.	0.01uF	50V	B	GRM188B11H103KA01D	K22174823		1-	A	C1
C 4772	CHIP CAP.	0.01uF	50V	B	GRM188B11H103KA01D	K22174823		1-	A	A1
C 4774	CHIP CAP.	0.01uF	50V	B	GRM188B11H103KA01D	K22174823		1-	A	A1
C 4775	CHIP CAP.	0.01uF	50V	B	GRM188B11H103KA01D	K22174823		1-	A	A1
C 4776	CHIP CAP.	0.01uF	50V	B	GRM188B11H103KA01D	K22174823		1-	A	A1
C 4777	CHIP CAP.	0.001uF	50V	B	GRM188B11H102KA01D	K22174821		1-	A	A1
C 4778	CHIP CAP.	0.01uF	50V	B	GRM188B11H103KA01D	K22174823		1-	A	A1
C 4779	CHIP CAP.	0.001uF	50V	B	GRM188B11H102KA01D	K22174821		1-	A	A1
C 4789	CHIP CAP.	0.01uF	50V	B	GRM188B11H103KA01D	K22174823		1-	A	H1
C 4790	CHIP CAP.	0.001uF	50V	B	GRM188B11H102KA01D	K22174821		1-	A	H1
C 4791	CHIP CAP.	0.01uF	50V	B	GRM188B11H103KA01D	K22174823		1-	A	H1
C 4792	CHIP CAP.	0.001uF	50V	B	GRM188B11H102KA01D	K22174821		1-	A	H1
C 4801	CHIP CAP.	0.01uF	50V	B	GRM188B11H103KA01D	K22174823		1-	A	H1
C 4802	CHIP CAP.	0.001uF	50V	B	GRM188B11H102KA01D	K22174821		1-	A	H1
C 4803	CHIP CAP.	0.01uF	50V	B	GRM188B11H103KA01D	K22174823		1-	A	H1
C 4804	CHIP CAP.	0.001uF	50V	B	GRM188B11H102KA01D	K22174821		1-	A	H1
C 4858	CHIP CAP.	0.001uF	50V	B	GRM188B11H102KA01D	K22174821		1-	A	I1
C 4859	CHIP CAP.	0.1uF	16V	B	GRM188B11C104KA01D	K22124805		1-	A	I1
C 4860	CHIP CAP.	0.001uF	50V	B	GRM188B11H102KA01D	K22174821		1-	A	I1
C 4861	CHIP CAP.	0.1uF	16V	B	GRM188B11C104KA01D	K22124805		1-	A	I1
C 4862	CHIP CAP.	0.001uF	50V	B	GRM188B11H102KA01D	K22174821		1-	A	I1
C 4863	CHIP CAP.	0.1uF	16V	B	GRM188B11C104KA01D	K22124805		1-	A	I1
C 4864	CHIP CAP.	0.001uF	50V	B	GRM188B11H102KA01D	K22174821		1-	A	I1
C 4865	CHIP CAP.	0.1uF	16V	B	GRM188B11C104KA01D	K22124805		1-	A	I1
C 4866	CHIP CAP.	0.001uF	50V	B	GRM188B11H102KA01D	K22174821		1-	A	I1
C 4867	CHIP CAP.	0.1uF	16V	B	GRM188B11C104KA01D	K22124805		1-	A	I1
C 4868	CHIP CAP.	0.01uF	50V	B	GRM188B11H103KA01D	K22174823		1-	A	D2
C 4869	CHIP TA.CAP.	22uF			TPSB226M016Y0600	K78120075		1-	A	C2
C 4870	CHIP CAP.	10pF	50V	CH	GRM1882C1H100JA01D	K22174211		1-	A	H1
C 4871	CHIP CAP.	10pF	50V	CH	GRM1882C1H100JA01D	K22174211		1-	A	H1
C 4872	CHIP CAP.	0.1uF	16V	B	GRM188B11C104KA01D	K22124805		1-	A	H2
C 4873	CHIP CAP.	10pF	50V	CH	GRM1882C1H100JA01D	K22174211		1-	A	H1
C 4874	CHIP CAP.	10pF	50V	CH	GRM1882C1H100JA01D	K22174211		1-	A	H1
C 4875	CHIP CAP.	0.01uF	50V	B	GRM188B11H103KA01D	K22174823		1-	A	H1
C 4876	CHIP CAP.	0.01uF	50V	B	GRM188B11H103KA01D	K22174823		1-	A	C1
C 4877	CHIP CAP.	0.1uF	16V	B	GRM188B11C104KA01D	K22124805		1-	A	H3
C 4878	CHIP CAP.	0.1uF	16V	B	GRM188B11C104KA01D	K22124805		1-	A	I3
C 4879	CHIP CAP.	0.1uF	16V	B	GRM188B11C104KA01D	K22124805		1-	A	I3
C 4880	CHIP CAP.	0.1uF	16V	B	GRM188B11C104KA01D	K22124805		1-	A	I3
C 4881	CHIP CAP.	0.1uF	16V	B	GRM188B11C104KA01D	K22124805		1-	A	I2
C 4882	CHIP CAP.	0.1uF	16V	B	GRM188B11C104KA01D	K22124805		1-	A	I2
C 4883	CHIP CAP.	0.1uF	16V	B	GRM188B11C104KA01D	K22124805		1-	A	H2
C 4884	CHIP CAP.	0.1uF	16V	B	GRM188B11C104KA01D	K22124805		1-	A	G2
C 4885	CHIP CAP.	0.1uF	16V	B	GRM188B11C104KA01D	K22124805		1-	A	H3
C 4886	CHIP CAP.	0.01uF	50V	B	GRM188B11H103KA01D	K22174823		1-	A	G3
C 4890	CHIP CAP.	0.1uF	16V	B	GRM188B11C104KA01D	K22124805		1-	A	B3
C 4891	CHIP CAP.	0.1uF	16V	B	GRM188B11C104KA01D	K22124805		1-	A	B3
C 4892	CHIP CAP.	0.1uF	16V	B	GRM188B11C104KA01D	K22124805		1-	A	B3
C 4893	CHIP CAP.	0.1uF	16V	B	GRM188B11C104KA01D	K22124805		1-	A	C3
C 4894	CHIP CAP.	0.1uF	16V	B	GRM188B11C104KA01D	K22124805		1-	A	B3
C 4895	CHIP CAP.	0.1uF	16V	B	GRM188B11C104KA01D	K22124805		1-	A	B3
C 4896	CHIP CAP.	0.1uF	16V	B	GRM188B11C104KA01D	K22124805		1-	A	B3
C 4897	CHIP CAP.	0.1uF	16V	B	GRM188B11C104KA01D	K22124805		1-	A	B3
C 4898	CHIP CAP.	0.1uF	16V	B	GRM188B11C104KA01D	K22124805		1-	A	B3
C 4899	CHIP CAP.	0.1uF	16V	B	GRM188B11C104KA01D	K22124805		1-	A	B3
C 4900	CHIP CAP.	0.1uF	16V	B	GRM188B11C104KA01D	K22124805		1-	A	B3
C 4901	CHIP CAP.	0.1uF	16V	B	GRM188B11C104KA01D	K22124805		1-	A	B3
C 4902	CHIP CAP.	0.1uF	16V	B	GRM188B11C104KA01D	K22124805		1-	A	B3
C 4903	CHIP CAP.	0.1uF	16V	B	GRM188B11C104KA01D	K22124805		1-	A	B3
C 4904	CHIP CAP.	0.1uF	16V	B	GRM188B11C104KA01D	K22124805		1-	A	B3
C 4905	CHIP CAP.	0.1uF	16V	B	GRM188B11C104KA01D	K22124805		1-	A	B3
C 4906	CHIP CAP.	0.1uF	16V	B	GRM188B11C104KA01D	K22124805		1-	A	B3
C 4907	CHIP CAP.	0.1uF	16V	B	GRM188B11C104KA01D	K22124805		1-	A	B3
C 4908	CHIP CAP.	0.1uF	16V	B	GRM188B11C104KA01D	K22124805		1-	A	B3
C 4909	CHIP CAP.	0.1uF	16V	B	GRM188B11C104KA01D	K22124805		1-	A	B3
C 4910	CHIP CAP.	0.1uF	16V	B	GRM188B11C104KA01D	K22124805		1-	A	B3

CNTL Unit

Parts List

REF	DESCRIPTION	VALUE	V/W	TOL.	MFR'S DESIG	VXSTD P/N	VERS.	LOT	SIDE	LAY ADR
C 4911	CHIP CAP.	0.1uF	16V	B	GRM188B11C104KA01D	K22124805		1-	A	B3
C 4912	CHIP CAP.	0.1uF	16V	B	GRM188B11C104KA01D	K22124805		1-	A	B3
C 4913	CHIP CAP.	0.1uF	16V	B	GRM188B11C104KA01D	K22124805		1-	A	B3
C 4914	CHIP CAP.	0.1uF	16V	B	GRM188B11C104KA01D	K22124805		1-	A	B3
C 4915	CHIP CAP.	0.1uF	16V	B	GRM188B11C104KA01D	K22124805		1-	A	B3
C 4916	CHIP CAP.	0.1uF	16V	B	GRM188B11C104KA01D	K22124805		1-	A	B3
C 4917	CHIP CAP.	0.1uF	16V	B	GRM188B11C104KA01D	K22124805		1-	A	B3
C 4918	CHIP TA.CAP.	22uF			TPSB226M016Y0600	K78120075		1-	A	E2
C 4919	CHIP CAP.	0.01uF	50V	B	GRM188B11H103KA01D	K22174823		1-	A	J3
C 4920	CHIP CAP.	47pF	50V	CH	GRM1882C1H470JA01D	K22174227		1-	A	G2
C 4921	CHIP CAP.	47pF	50V	CH	GRM1882C1H470JA01D	K22174227		1-	A	G2
C 4922	CHIP CAP.	47pF	50V	CH	GRM1882C1H470JA01D	K22174227		1-	A	G2
C 4923	CHIP CAP.	47pF	50V	CH	GRM1882C1H470JA01D	K22174227		1-	A	G2
C 4924	CHIP CAP.	47pF	50V	CH	GRM1882C1H470JA01D	K22174227		1-	A	H2
C 4925	CHIP CAP.	47pF	50V	CH	GRM1882C1H470JA01D	K22174227		1-	A	H2
C 4926	CHIP CAP.	47pF	50V	CH	GRM1882C1H470JA01D	K22174227		1-	A	H2
C 4927	CHIP CAP.	47pF	50V	CH	GRM1882C1H470JA01D	K22174227		1-	A	H2
C 4928	CHIP CAP.	47pF	50V	CH	GRM1882C1H470JA01D	K22174227		1-	A	H2
C 4929	CHIP CAP.	47pF	50V	CH	GRM1882C1H470JA01D	K22174227		1-	A	H2
C 4930	CHIP CAP.	10pF	50V	CH	GRM1882C1H100JA01D	K22174211		1-	A	H2
C 4931	CHIP CAP.	10pF	50V	CH	GRM1882C1H100JA01D	K22174211		1-	A	H2
C 4935	CHIP TA.CAP.	10uF	16V		TEESVA1C106M8R	K78120077		1-	A	G2
C 4936	CHIP TA.CAP.	10uF	16V		TEESVA1C106M8R	K78120077		1-	A	G3
C 4937	CHIP CAP.	100pF	50V	CH	GRM1882C1H101JA01D	K22174235		1-	A	G2
C 4938	CHIP CAP.	0.1uF	16V	B	GRM188B11C104KA01D	K22124805		1-	A	G2
C 4939	CHIP CAP.	100pF	50V	CH	GRM1882C1H101JA01D	K22174235		1-	A	H2
C 4949	CHIP CAP.	0.22uF	10V	B	GRM188B11A224KA01D	K22104801		1-	A	G3
C 4950	CHIP CAP.	0.01uF	50V	B	GRM188B11H103KA01D	K22174823		1-	A	G3
C 4952	CHIP CAP.	0.01uF	50V	B	GRM188B11H103KA01D	K22174823		1-	A	I1
C 4958	CHIP CAP.	0.01uF	50V	B	GRM188B11H103KA01D	K22174823		1-	A	J2
C 4960	CHIP CAP.	0.1uF	16V	B	GRM188B11C104KA01D	K22124805		1-	A	B3
D 4501	LED				SML-210VTT86	G2070768		1-	A	B1
D 4506	DIODE				RB051L-40TE25	G2070718		1-	A	B1
D 4509	DIODE				IMN10 T108	G2070078		1-	A	A3
D 4510	DIODE				IMN10 T108	G2070078		1-	A	A3
D 4511	DIODE				IMN10 T108	G2070078		1-	A	A3
D 4512	DIODE				IMN10 T108	G2070078		1-	A	A3
D 4517	DIODE				BAS316	G2070716		1-	A	C2
D 4520	DIODE				1SS294(TE85R.F)	G2070058		1-	A	D3
D 4521	DIODE				DAP202U T106	G2070160		1-	A	F2
D 4522	DIODE				BAS316	G2070716		1-	A	D2
D 4523	DIODE				IMN10 T108	G2070078		1-	A	A2
D 4524	DIODE				HZM4.7NB2 TR-E	G2070782		1-	A	H3
D 4525	DIODE				IMN10 T108	G2070078		1-	A	A2
D 4526	DIODE				IMN10 T108	G2070078		1-	A	A2
D 4529	DIODE				IMN10 T108	G2070078		1-	A	A2
D 4530	DIODE				BAS316	G2070716		1-	A	G1
D 4533	DIODE				RB751S-40TE61	G2070850		1-	A	B3
D 4534	DIODE				BAS316	G2070716		1-	A	B3
D 4535	DIODE				IMN10 T108	G2070078		1-	A	A2
D 4536	DIODE				BAS316	G2070716		1-	A	A3
F 4501	PROTECTOR				ICP-S2.3TN	G9090144		1-	A	J1
FB4501	FERRITE BEADS				FBMH3225HM102NT	L9190173		1-	A	I2
J 4501	CONNECTOR				SC25-08WS	P0090627		1-	A	A1
J 4502	CONNECTOR				12FLT-SM2-TB(LF)(SN)	P1091198		1-	A	H1
J 4503	CONNECTOR				XM2C-0942-232L	P0091409		1-	A	K2
J 4504	CONNECTOR				TCS7705-5120177	P1091244		1-	A	K1
J 4505	CONNECTOR				M50-008-020 R41-9553F	P1091132		1-	A	K1
J 4506	CONNECTOR				SB20-04WS	P0090611		1-	A	I1
J 4507	CONNECTOR				40FLT-SM2-TB(LF)(SN)(M)	P1091251		1-	A	A3
J 4508	CONNECTOR				40FLT-SM2-TB(LF)(SN)(M)	P1091251		1-	A	A2
J 4509	CONNECTOR				30FLT-SM2-TB(LF)(SN)(M)	P1091142		1-	A	C1
J 4510	CONNECTOR				30FLT-SM2-TB(LF)(SN)(M)	P1091142		1-	A	A1
J 4511	CONNECTOR				18FLT-SM2-TB(LF)(SN)(M)	P1091176		1-	A	A1
J 4512	CONNECTOR				24FLT-SM2-TB(LF)(SN)(M)	P1091128		1-	A	H1
J 4513	CONNECTOR				SB20-06WS	P0090613		1-	A	I1
J 4514	CONNECTOR				30FLT-SM2-TB(LF)(SN)(M)	P1091142		1-	A	G1
J 4515	CONNECTOR				30FLT-SM2-TB(LF)(SN)(M)	P1091142		1-	A	F1
J 4516	CONNECTOR				30FLT-SM2-TB(LF)(SN)(M)	P1091142		1-	A	E1
J 4517	CONNECTOR				YKB21-5296N	P1091233		1-	A	K4
J 4522	CONNECTOR				SB20-06WS	P0090613		1-	A	I1
JP4501	CHIP RES.	0	1/16W	5%	RMC1/16 000JATP	J24185000		1-	A	A3
JP4502	CHIP RES.	0	1/16W	5%	RMC1/16 000JATP	J24185000		1-	A	A3

CNTL Unit

Parts List

REF	DESCRIPTION	VALUE	V/W	TOL.	MFR'S DESIG	VXSTD P/N	VERS.	LOT	SIDE	LAY ADR
JP4503	CHIP RES.	0	1/16W	5%	RMC1/16 000JATP	J24185000		1-	A	A3
JP4506	CHIP RES.	0	1/16W	5%	RMC1/16 000JATP	J24185000		1-	A	A3
JP4507	CHIP RES.	0	1/16W	5%	RMC1/16 000JATP	J24185000		1-	A	A3
JP4510	CHIP RES.	0	1/16W	5%	RMC1/16 000JATP	J24185000		19-	A	A3
L 4501	M.RFC	1000uH			LLM3225-102J	L1691157		1-	A	J3
L 4502	M.RFC	100uH			FLC32T-101J	L1690227		1-	A	J2
L 4503	M.RFC	470uH			CDRH105RNP-471NC-VS	L1691359		1-	A	C3
L 4504	M.RFC	100uH			FLC32T-101J	L1690227		1-	A	J1
L 4505	M.RFC	470uH			CDRH105RNP-471NC-VS	L1691359		1-	A	D3
L 4506	CHIP COIL	1500uH			A814AY-152K=P3	L1691320		1-	A	D3
L 4507	M.RFC	1uH			LK1608 1R0K-T	L1690687		1-	A	G2
Q 4501	IC				KIA7805API	G1093163		1-	A	C1
Q 4502	IC				BA033CC0FP-E2	G1094077		1-	A	E1
Q 4503	IC				KIA7805API	G1093163		1-	A	D1
Q 4504	IC				BA033T	G1093776		1-	A	D1
Q 4505	IC				PST3445UR	G1093232		1-	A	C2
Q 4506	IC				BU4052BCFV-E2	G1094196		1-	A	B3
Q 4507	IC				BU4052BCFV-E2	G1094196		1-	A	B3
Q 4508	IC				ADM3202ARU	G1094022		1-	A	J2
Q 4509	IC				NJM2374AE-TE1	G1093808		1-	A	D3
Q 4510	TRANSISTOR				2SA1576A T106 R	G3115768R		1-	A	C2
Q 4511	TRANSISTOR				2SC4081 T106	G3340818		1-	A	D3
Q 4512	IC				BU4052BCFV-E2	G1094196		1-	A	B3
Q 4513	IC				BU4052BCFV-E2	G1094196		1-	A	C3
Q 4514	IC				ADM3202ARU	G1094022		1-	A	J2
Q 4515	TRANSISTOR				UMG2N TR	G3070088		1-	A	H1
Q 4516	TRANSISTOR				DTC114YUA T106	G3070298		1-	A	G1
Q 4517	TRANSISTOR				2SB1132 T100 R	G3211327R		1-	A	D3
Q 4518	TRANSISTOR				2SC4081 T106	G3340818		1-	A	D2
Q 4519	TRANSISTOR				2SA1576A T106 R	G3115768R		1-	A	D2
Q 4520	IC				TC7W08FU(TE12L.F)	G1092264		1-	A	F2
Q 4521	IC				FM24CL64	G1094270		1-	A	H3
Q 4522	IC				SN74LVC3G17DCTR	G1094419		1-	A	I1
Q 4523	IC				CD74HC238M96(TAPE)	G1094411		1-	A	B2
Q 4524	IC				CD74HC238M96(TAPE)	G1094411		1-	A	B2
Q 4525	IC				BU2507FV-E2	G1093773		1-	A	F3
Q 4526	TRANSISTOR				2SB624-T2B BV3	G3206247C		1-	A	H1
Q 4527	TRANSISTOR				2SB624-T2B BV3	G3206247C		1-	A	H1
Q 4528	TRANSISTOR				2SB624-T2B BV3	G3206247C		1-	A	H1
Q 4529	TRANSISTOR				DTC114YUA T106	G3070298		1-	A	G1
Q 4530	TRANSISTOR				DTC114YUA T106	G3070298		1-	A	G1
Q 4531	TRANSISTOR				DTC114YUA T106	G3070298		1-	A	I2
Q 4532	TRANSISTOR				DTC114EUA T106	G3070084		1-	A	F2
Q 4533	IC				SN74LVC3G17DCTR	G1094419		1-	A	F3
Q 4534	IC				CD4093BPWR	G1094093		1-	A	B3
Q 4535	IC				CD4030BPWR	G1094092		1-	A	B2
Q 4536	IC				M62364FP 600D	G1093033		1-	A	B1
Q 4537	IC				NJU3714A(TAPE)	G1094291		1-	A	B1
Q 4538	IC				SN74LVC3G17DCTR	G1094419		1-	A	G1
Q 4539	IC				SN74HCT244PWR	G1094091		1-	A	B2
Q 4540	IC				BU4069UBFV-E2	G1093601		1-	A	B2
Q 4541	IC				LM2902PWR	G1094009		1-	A	F2
Q 4542	IC				BU4053BCFV-E2	G1093422		1-	A	F2
Q 4543	IC				CD74HC238M96(TAPE)	G1094411		1-	A	I3
Q 4544	IC				CD74HC238M96(TAPE)	G1094411		1-	A	G2
Q 4545	IC				SN74HC08PWR	G1094724		1-	A	G2
Q 4546	IC				CD74HC238M96(TAPE)	G1094411		1-	A	I3
Q 4547	IC				SN74HC08PWR	G1094724		1-	A	H2
Q 4548	IC				CD74HC238M96(TAPE)	G1094411		1-	A	J3
Q 4549	IC				SN74HC08PWR	G1094724		1-	A	H2
Q 4550	IC				CD74HC238M96(TAPE)	G1094411		1-	A	J3
Q 4551	IC				SN74LVC1G04DCKR	G1093972		1-	A	J3
Q 4552	IC				R5F61663N50FPV			1-	A	H2
Q 4553	TRANSISTOR				DTC114YUA T106	G3070298		1-	A	H1
Q 4554	IC				BU4069UBFV-E2	G1093601		1-	A	B1
Q 4555	IC				BU4053BCFV-E2	G1093422		1-	A	G3
Q 4556	IC				BU4069UBFV-E2	G1093601		1-	A	I4
Q 4558	IC				LM2904PWR	G1094010		1-	A	B2
Q 4559	IC				NJU3714A(TAPE)	G1094291		1-	A	G3
Q 4560	IC				SN74LVC1G04DCKR	G1093972		1-	A	J2
R 4501	CHIP RES.	4.7k	1/16W	5%	RMC1/16 472JATP	J24185472		1-	A	I1
R 4502	CHIP RES.	47k	1/16W	5%	RMC1/16 473JATP	J24185473		1-	A	I1
R 4504	CHIP RES.	47k	1/16W	5%	RMC1/16 473JATP	J24185473		1-	A	I1

CNTL Unit

Parts List

REF	DESCRIPTION	VALUE	V/W	TOL.	MFR'S DESIG	VXSTD P/N	VERS.	LOT	SIDE	LAY ADR
R 4505	CHIP RES.	0	1/16W	5%	RMC1/16 000JATP	J24185000		1-	A	J2
R 4506	CHIP RES.	0	1/16W	5%	RMC1/16 000JATP	J24185000		1-	A	J2
R 4507	CHIP RES.	0	1/16W	5%	RMC1/16 000JATP	J24185000		1-	A	J2
R 4508	CHIP RES.	0	1/16W	5%	RMC1/16 000JATP	J24185000		1-	A	J3
R 4509	CHIP RES.	0	1/16W	5%	RMC1/16 000JATP	J24185000		1-	A	H2
R 4510	CHIP RES.	0	1/16W	5%	RMC1/16 000JATP	J24185000		1-	A	H3
R 4511	CHIP RES.	100	1/16W	5%	RMC1/16 101JATP	J24185101		1-	A	J1
R 4512	CHIP RES.	100	1/16W	5%	RMC1/16 101JATP	J24185101		1-	A	J1
R 4513	CHIP RES.	10	1/16W	5%	RMC1/16 100JATP	J24185100		1-	A	J1
R 4514	CHIP RES.	100	1/16W	5%	RMC1/16 101JATP	J24185101		1-	A	J1
R 4515	CHIP RES.	100	1/16W	5%	RMC1/16 101JATP	J24185101		1-	A	J1
R 4516	CHIP RES.	10	1/16W	5%	RMC1/16 100JATP	J24185100		1-	A	J1
R 4517	CHIP RES.	10	1/16W	5%	RMC1/16 100JATP	J24185100		1-	A	J1
R 4518	CHIP RES.	10	1/16W	5%	RMC1/16 100JATP	J24185100		1-	A	J1
R 4519	CHIP RES.	0	1/16W	5%	RMC1/16 000JATP	J24185000		1-	A	J2
R 4520	CHIP RES.	0	1/16W	5%	RMC1/16 000JATP	J24185000		1-	A	J2
R 4521	CHIP RES.	0	1/16W	5%	RMC1/16 000JATP	J24185000		1-	A	J1
R 4522	CHIP RES.	0	1/16W	5%	RMC1/16 000JATP	J24185000		1-	A	J1
R 4523	CHIP RES.	0	1/16W	5%	RMC1/16 000JATP	J24185000		1-	A	J1
R 4524	CHIP RES.	4.7k	1/16W	5%	RMC1/16 472JATP	J24185472		1-	A	J1
R 4525	CHIP RES.	2.7k	1/16W	5%	RMC1/16 272JATP	J24185272		1-	A	B1
R 4526	CHIP RES.	2.7k	1/16W	5%	RMC1/16 272JATP	J24185272		1-	A	B1
R 4529	CHIP RES.	3.9	1W	5%	RMC1 3R9JTE	J24305399		1-	A	C2
R 4530	CHIP RES.	3.9	1W	5%	RMC1 3R9JTE	J24305399		1-	A	C1
R 4531	CHIP RES.	3.9	1W	5%	RMC1 3R9JTE	J24305399		1-	A	D2
R 4532	CHIP RES.	3.9	1W	5%	RMC1 3R9JTE	J24305399		1-	A	D1
R 4533	CHIP RES.	10k	1/16W	1%	RMC1/16 103FTP	J24183103		1-	A	C2
R 4534	CHIP RES.	22	1W	5%	RMC1 220JTE	J24305220		1-	A	C1
R 4535	CHIP RES.	10k	1/16W	1%	RMC1/16 103FTP	J24183103		1-	A	C2
R 4542	CHIP RES.	1	1/10W	5%	RMC1/10T 1R0J	J24205010		1-	A	D3
R 4543	CHIP RES.	1	1/10W	5%	RMC1/10T 1R0J	J24205010		1-	A	D3
R 4544	CHIP RES.	1k	1/16W	5%	RMC1/16 102JATP	J24185102		1-	A	D3
R 4545	CHIP RES.	1	1/10W	5%	RMC1/10T 1R0J	J24205010		1-	A	D3
R 4546	CHIP RES.	4.7k	1/16W	5%	RMC1/16 472JATP	J24185472		1-	A	C2
R 4547	CHIP RES.	10k	1/16W	5%	RMC1/16 103JATP	J24185103		1-	A	C2
R 4548	CHIP RES.	10k	1/16W	5%	RMC1/16 103JATP	J24185103		1-	A	D2
R 4549	CHIP RES.	100k	1/16W	5%	RMC1/16 104JATP	J24185104		1-	A	D3
R 4550	CHIP RES.	100k	1/16W	5%	RMC1/16 104JATP	J24185104		1-	A	D3
R 4552	CHIP RES.	47k	1/16W	5%	RMC1/16 473JATP	J24185473		1-	A	C2
R 4553	CHIP RES.	47k	1/16W	5%	RMC1/16 473JATP	J24185473		1-	A	C2
R 4554	CHIP RES.	0	1/16W	5%	RMC1/16 000JATP	J24185000		1-	A	B3
R 4555	CHIP RES.	4.7k	1/16W	5%	RMC1/16 472JATP	J24185472		1-	A	B3
R 4556	CHIP RES.	0	1/16W	5%	RMC1/16 000JATP	J24185000		1-	A	C3
R 4557	CHIP RES.	0	1/16W	5%	RMC1/16 000JATP	J24185000		1-	A	C3
R 4558	CHIP RES.	0	1/16W	5%	RMC1/16 000JATP	J24185000		1-	A	J2
R 4559	CHIP RES.	0	1/16W	5%	RMC1/16 000JATP	J24185000		1-	A	J1
R 4563	CHIP RES.	1	1/10W	5%	RMC1/10T 1R0J	J24205010		1-	A	D3
R 4564	CHIP RES.	1k	1/16W	5%	RMC1/16 102JATP	J24185102		1-	A	D3
R 4565	CHIP RES.	6.2k	1/16W	1%	RMC1/16 622FTP	J24183622		1-	A	D3
R 4566	CHIP RES.	1k	1/16W	1%	RMC1/16 102FTP	J24183102		1-	A	D3
R 4567	CHIP RES.	330k	1/16W	5%	RMC1/16 334JATP	J24185334		1-	A	D2
R 4568	CHIP RES.	100k	1/16W	5%	RMC1/16 104JATP	J24185104		1-	A	D2
R 4569	CHIP RES.	47k	1/16W	5%	RMC1/16 473JATP	J24185473		1-	A	D2
R 4570	CHIP RES.	10k	1/16W	5%	RMC1/16 103JATP	J24185103		1-	A	D2
R 4571	CHIP RES.	4.7k	1/16W	5%	RMC1/16 472JATP	J24185472		1-	A	D2
R 4572	CHIP RES.	10	1/16W	5%	RMC1/16 100JATP	J24185100		1-	A	H3
R 4573	CHIP RES.	47k	1/16W	5%	RMC1/16 473JATP	J24185473		1-	A	D2
R 4574	CHIP RES.	10k	1/16W	5%	RMC1/16 103JATP	J24185103		1-	A	D2
R 4575	CHIP RES.	0	1/16W	5%	RMC1/16 000JATP	J24185000		1-	A	I1
R 4576	CHIP RES.	1k	1/16W	5%	RMC1/16 102JATP	J24185102		1-	A	I1
R 4577	CHIP RES.	10k	1/16W	5%	RMC1/16 103JATP	J24185103		1-	A	I1
R 4578	CHIP RES.	10k	1/16W	5%	RMC1/16 103JATP	J24185103		1	A	I1
R 4578	CHIP RES.	47k	1/16W	5%	RMC1/16 473JATP	J24185473		2-	A	I1
R 4579	CHIP RES.	1k	1/16W	5%	RMC1/16 102JATP	J24185102		1-	A	I1
R 4580	CHIP RES.	10k	1/16W	5%	RMC1/16 103JATP	J24185103		1	A	I1
R 4580	CHIP RES.	47k	1/16W	5%	RMC1/16 473JATP	J24185473		2-	A	I1
R 4581	CHIP RES.	10	1/16W	5%	RMC1/16 100JATP	J24185100		1-	A	F3
R 4582	CHIP RES.	100	1/16W	5%	RMC1/16 101JATP	J24185101		1-	A	F2
R 4583	CHIP RES.	100	1/16W	5%	RMC1/16 101JATP	J24185101		1-	A	F3
R 4584	CHIP RES.	100	1/16W	5%	RMC1/16 101JATP	J24185101		1-	A	F2
R 4586	CHIP RES.	1k	1/16W	5%	RMC1/16 102JATP	J24185102		1-	A	H1
R 4587	CHIP RES.	1k	1/16W	5%	RMC1/16 102JATP	J24185102		1-	A	H1
R 4588	CHIP RES.	1k	1/16W	5%	RMC1/16 102JATP	J24185102		1-	A	G1

CNTL Unit

Parts List

REF	DESCRIPTION	VALUE	V/W	TOL.	MFR'S DESIG	VXSTD P/N	VERS.	LOT	SIDE	LAY ADR
R 4589	CHIP RES.	0	1/16W	5%	RMC1/16 000JATP	J24185000		1-	A	G1
R 4590	CHIP RES.	100k	1/16W	5%	RMC1/16 104JATP	J24185104		1-	A	G1
R 4591	CHIP RES.	10k	1/16W	5%	RMC1/16 103JATP	J24185103		1-	A	F2
R 4592	CHIP RES.	47k	1/16W	5%	RMC1/16 473JATP	J24185473		1-	A	I2
R 4593	CHIP RES.	10k	1/16W	5%	RMC1/16 103JATP	J24185103		1-	A	F2
R 4594	CHIP RES.	4.7k	1/16W	5%	RMC1/16 472JATP	J24185472		1-	A	F2
R 4595	CHIP RES.	2.2k	1/16W	5%	RMC1/16 222JATP	J24185222		1-	A	H3
R 4596	CHIP RES.	2.2k	1/16W	5%	RMC1/16 222JATP	J24185222		1-	A	H3
R 4597	CHIP RES.	270	1/16W	5%	RMC1/16 271JATP	J24185271		1-	A	H3
R 4598	CHIP RES.	1k	1/16W	5%	RMC1/16 102JATP	J24185102		1-	A	F2
R 4599	CHIP RES.	1k	1/16W	5%	RMC1/16 102JATP	J24185102		1-	A	F3
R 4600	CHIP RES.	10k	1/16W	5%	RMC1/16 103JATP	J24185103		1	A	F3
R 4600	CHIP RES.	47k	1/16W	5%	RMC1/16 473JATP	J24185473		2-	A	F3
R 4601	CHIP RES.	10k	1/16W	5%	RMC1/16 103JATP	J24185103		1	A	F2
R 4601	CHIP RES.	47k	1/16W	5%	RMC1/16 473JATP	J24185473		2-	A	F2
R 4602	CHIP RES.	10k	1/16W	5%	RMC1/16 103JATP	J24185103		1-	A	A2
R 4603	CHIP RES.	47k	1/16W	5%	RMC1/16 473JATP	J24185473		1-	A	A2
R 4604	CHIP RES.	1k	1/16W	5%	RMC1/16 102JATP	J24185102		1-	A	F3
R 4605	CHIP RES.	10k	1/16W	5%	RMC1/16 103JATP	J24185103		1	A	F3
R 4605	CHIP RES.	47k	1/16W	5%	RMC1/16 473JATP	J24185473		2-	A	F3
R 4606	CHIP RES.	10k	1/16W	5%	RMC1/16 103JATP	J24185103		1-	A	A2
R 4607	CHIP RES.	47k	1/16W	5%	RMC1/16 473JATP	J24185473		1-	A	A2
R 4608	CHIP RES.	22k	1/16W	5%	RMC1/16 223JATP	J24185223		1-	A	B3
R 4609	CHIP RES.	100	1/16W	5%	RMC1/16 101JATP	J24185101		1-	A	B1
R 4610	CHIP RES.	100	1/16W	5%	RMC1/16 101JATP	J24185101		1-	A	B1
R 4611	CHIP RES.	100	1/16W	5%	RMC1/16 101JATP	J24185101		1-	A	B1
R 4612	CHIP RES.	100k	1/16W	5%	RMC1/16 104JATP	J24185104		1-	A	B1
R 4613	CHIP RES.	100	1/16W	5%	RMC1/16 101JATP	J24185101		1-	A	B1
R 4614	CHIP RES.	100	1/16W	5%	RMC1/16 101JATP	J24185101		1-	A	B1
R 4615	CHIP RES.	100	1/16W	5%	RMC1/16 101JATP	J24185101		1-	A	B1
R 4616	CHIP RES.	1k	1/16W	5%	RMC1/16 102JATP	J24185102		1-	A	G2
R 4617	CHIP RES.	1k	1/16W	5%	RMC1/16 102JATP	J24185102		1-	A	G1
R 4618	CHIP RES.	10k	1/16W	5%	RMC1/16 103JATP	J24185103		1	A	G1
R 4618	CHIP RES.	47k	1/16W	5%	RMC1/16 473JATP	J24185473		2-	A	G1
R 4619	CHIP RES.	10k	1/16W	5%	RMC1/16 103JATP	J24185103		1	A	G1
R 4619	CHIP RES.	47k	1/16W	5%	RMC1/16 473JATP	J24185473		2-	A	G1
R 4620	CHIP RES.	10k	1/16W	5%	RMC1/16 103JATP	J24185103		1-	A	B2
R 4621	CHIP RES.	1k	1/16W	5%	RMC1/16 102JATP	J24185102		1-	A	G1
R 4622	CHIP RES.	10k	1/16W	5%	RMC1/16 103JATP	J24185103		1	A	G1
R 4622	CHIP RES.	47k	1/16W	5%	RMC1/16 473JATP	J24185473		2-	A	G1
R 4623	CHIP RES.	47k	1/16W	5%	RMC1/16 473JATP	J24185473		1-	A	B2
R 4624	CHIP RES.	10k	1/16W	5%	RMC1/16 103JATP	J24185103		1-	A	B2
R 4625	CHIP RES.	47k	1/16W	5%	RMC1/16 473JATP	J24185473		1-	A	B2
R 4626	CHIP RES.	0	1/16W	5%	RMC1/16 000JATP	J24185000		1-	A	B2
R 4627	CHIP RES.	22k	1/16W	5%	RMC1/16 223JATP	J24185223		1-	A	B2
R 4628	CHIP RES.	3.3k	1/16W	5%	RMC1/16 332JATP	J24185332		1-	A	F2
R 4631	CHIP RES.	39k	1/16W	5%	RMC1/16 393JATP	J24185393		1-	A	F2
R 4633	CHIP RES.	0	1/16W	5%	RMC1/16 000JATP	J24185000		1-	A	B1
R 4634	CHIP RES.	4.7k	1/16W	5%	RMC1/16 472JATP	J24185472		1-	A	B1
R 4635	CHIP RES.	39k	1/16W	5%	RMC1/16 393JATP	J24185393		1-	A	F2
R 4636	CHIP RES.	10k	1/16W	5%	RMC1/16 103JATP	J24185103		1-	A	F2
R 4637	CHIP RES.	4.7k	1/16W	5%	RMC1/16 472JATP	J24185472		1-	A	F2
R 4638	CHIP RES.	5.6k	1/16W	1%	RMC1/16 562FTP	J24183562		1-	A	B3
R 4639	CHIP RES.	10k	1/16W	5%	RMC1/16 103JATP	J24185103		1-	A	B3
R 4640	CHIP RES.	10k	1/16W	5%	RMC1/16 103JATP	J24185103		1-	A	B3
R 4641	CHIP RES.	39k	1/16W	5%	RMC1/16 393JATP	J24185393		1-	A	F2
R 4642	CHIP RES.	10k	1/16W	5%	RMC1/16 103JATP	J24185103		1-	A	F2
R 4643	CHIP RES.	27k	1/16W	5%	RMC1/16 273JATP	J24185273		1-	A	F2
R 4644	CHIP RES.	27k	1/16W	5%	RMC1/16 273JATP	J24185273		1-	A	F2
R 4645	CHIP RES.	39k	1/16W	5%	RMC1/16 393JATP	J24185393		1-	A	F2
R 4646	CHIP RES.	10k	1/16W	5%	RMC1/16 103JATP	J24185103		1-	A	F2
R 4647	CHIP RES.	27k	1/16W	5%	RMC1/16 273JATP	J24185273		1-	A	F2
R 4648	CHIP RES.	27k	1/16W	5%	RMC1/16 273JATP	J24185273		1-	A	F2
R 4649	CHIP RES.	10k	1/16W	5%	RMC1/16 103JATP	J24185103		1-	A	F2
R 4650	CHIP RES.	10k	1/16W	5%	RMC1/16 103JATP	J24185103		1-	A	F2
R 4651	CHIP RES.	10k	1/16W	5%	RMC1/16 103JATP	J24185103		1-	A	F2
R 4652	CHIP RES.	100	1/16W	5%	RMC1/16 101JATP	J24185101		1-	A	A3
R 4654	CHIP RES.	100	1/16W	5%	RMC1/16 101JATP	J24185101		1-	A	A2
R 4655	CHIP RES.	100	1/16W	5%	RMC1/16 101JATP	J24185101		1-	A	A2
R 4656	CHIP RES.	100	1/16W	5%	RMC1/16 101JATP	J24185101		1-	A	A2
R 4657	CHIP RES.	100	1/16W	5%	RMC1/16 101JATP	J24185101		1-	A	A2
R 4658	CHIP RES.	100	1/16W	5%	RMC1/16 101JATP	J24185101		1-	A	B1
R 4659	CHIP RES.	100	1/16W	5%	RMC1/16 101JATP	J24185101		1-	A	B1

CNTL Unit

Parts List

REF	DESCRIPTION	VALUE	V/W	TOL.	MFR'S DESIG	VXSTD P/N	VERS.	LOT	SIDE	LAY ADR
R 4660	CHIP RES.	100	1/16W	5%	RMC1/16 101JATP	J24185101		1-	A	B1
R 4661	CHIP RES.	100	1/16W	5%	RMC1/16 101JATP	J24185101		1-	A	B1
R 4662	CHIP RES.	100	1/16W	5%	RMC1/16 101JATP	J24185101		1-	A	B1
R 4663	CHIP RES.	100	1/16W	5%	RMC1/16 101JATP	J24185101		1-	A	B1
R 4664	CHIP RES.	100	1/16W	5%	RMC1/16 101JATP	J24185101		1-	A	B1
R 4665	CHIP RES.	100	1/16W	5%	RMC1/16 101JATP	J24185101		1-	A	B1
R 4666	CHIP RES.	100	1/16W	5%	RMC1/16 101JATP	J24185101		1-	A	C1
R 4667	CHIP RES.	100	1/16W	5%	RMC1/16 101JATP	J24185101		1-	A	C1
R 4668	CHIP RES.	100	1/16W	5%	RMC1/16 101JATP	J24185101		1-	A	A1
R 4669	CHIP RES.	100	1/16W	5%	RMC1/16 101JATP	J24185101		1-	A	A1
R 4670	CHIP RES.	100	1/16W	5%	RMC1/16 101JATP	J24185101		1-	A	G2
R 4671	CHIP RES.	100	1/16W	5%	RMC1/16 101JATP	J24185101		1-	A	A1
R 4672	CHIP RES.	100	1/16W	5%	RMC1/16 101JATP	J24185101		1-	A	G3
R 4673	CHIP RES.	100	1/16W	5%	RMC1/16 101JATP	J24185101		1-	A	G2
R 4674	CHIP RES.	100	1/16W	5%	RMC1/16 101JATP	J24185101		1-	A	H1
R 4675	CHIP RES.	100	1/16W	5%	RMC1/16 101JATP	J24185101		1-	A	H1
R 4676	CHIP RES.	100	1/16W	5%	RMC1/16 101JATP	J24185101		1-	A	H1
R 4677	CHIP RES.	100	1/16W	5%	RMC1/16 101JATP	J24185101		1-	A	H1
R 4678	CHIP RES.	100	1/16W	5%	RMC1/16 101JATP	J24185101		1-	A	F1
R 4679	CHIP RES.	100	1/16W	5%	RMC1/16 101JATP	J24185101		1-	A	F1
R 4680	CHIP RES.	100	1/16W	5%	RMC1/16 101JATP	J24185101		1-	A	F1
R 4681	CHIP RES.	100	1/16W	5%	RMC1/16 101JATP	J24185101		1-	A	F1
R 4682	CHIP RES.	100	1/16W	5%	RMC1/16 101JATP	J24185101		1-	A	F1
R 4683	CHIP RES.	100	1/16W	5%	RMC1/16 101JATP	J24185101		1-	A	F1
R 4684	CHIP RES.	100	1/16W	5%	RMC1/16 101JATP	J24185101		1-	A	F1
R 4685	CHIP RES.	100	1/16W	5%	RMC1/16 101JATP	J24185101		1-	A	F1
R 4686	CHIP RES.	100	1/16W	5%	RMC1/16 101JATP	J24185101		1-	A	E1
R 4687	CHIP RES.	100	1/16W	5%	RMC1/16 101JATP	J24185101		1-	A	E1
R 4688	CHIP RES.	100	1/16W	5%	RMC1/16 101JATP	J24185101		1-	A	E1
R 4689	CHIP RES.	100	1/16W	5%	RMC1/16 101JATP	J24185101		1-	A	E1
R 4690	CHIP RES.	100	1/16W	5%	RMC1/16 101JATP	J24185101		1-	A	E1
R 4691	CHIP RES.	1M	1/16W	5%	RMC1/16 105JATP	J24185105		1-	A	B3
R 4692	CHIP RES.	1M	1/16W	5%	RMC1/16 105JATP	J24185105		1-	A	B3
R 4693	CHIP RES.	1M	1/16W	5%	RMC1/16 105JATP	J24185105		1-	A	B3
R 4694	CHIP RES.	1M	1/16W	5%	RMC1/16 105JATP	J24185105		1-	A	B3
R 4695	CHIP RES.	47k	1/16W	5%	RMC1/16 473JATP	J24185473		1-	A	A1
R 4696	CHIP RES.	47k	1/16W	5%	RMC1/16 473JATP	J24185473		1-	A	A1
R 4697	CHIP RES.	47k	1/16W	5%	RMC1/16 473JATP	J24185473		1-	A	A1
R 4698	CHIP RES.	47k	1/16W	5%	RMC1/16 473JATP	J24185473		1-	A	A1
R 4699	CHIP RES.	220	1/16W	5%	RMC1/16 221JATP	J24185221		1-	A	H2
R 4700	CHIP RES.	10k	1/16W	5%	RMC1/16 103JATP	J24185103		1-	A	H2
R 4701	CHIP RES.	10k	1/16W	5%	RMC1/16 103JATP	J24185103		1-	A	H2
R 4702	CHIP RES.	0	1/16W	5%	RMC1/16 000JATP	J24185000		1-	A	H2
R 4703	CHIP RES.	0	1/16W	5%	RMC1/16 000JATP	J24185000		1-	A	H2
R 4704	CHIP RES.	0	1/16W	5%	RMC1/16 000JATP	J24185000		1-	A	H2
R 4705	CHIP RES.	0	1/16W	5%	RMC1/16 000JATP	J24185000		1-	A	H2
R 4706	CHIP RES.	0	1/16W	5%	RMC1/16 000JATP	J24185000		1-	A	H2
R 4707	CHIP RES.	56k	1/16W	1%	RMC1/16 563FTP	J24183563		1-	A	B3
R 4708	CHIP RES.	0	1/16W	5%	RMC1/16 000JATP	J24185000		1-	A	H2
R 4709	CHIP RES.	0	1/16W	5%	RMC1/16 000JATP	J24185000		1-	A	H2
R 4710	CHIP RES.	0	1/16W	5%	RMC1/16 000JATP	J24185000		1-	A	H2
R 4711	CHIP RES.	10k	1/16W	5%	RMC1/16 103JATP	J24185103		1-	A	H3
R 4712	CHIP RES.	10k	1/16W	5%	RMC1/16 103JATP	J24185103		1-	A	H3
R 4713	CHIP RES.	1M	1/16W	5%	RMC1/16 105JATP	J24185105		1-	A	B3
R 4714	CHIP RES.	1M	1/16W	5%	RMC1/16 105JATP	J24185105		1-	A	B3
R 4715	CHIP RES.	1M	1/16W	5%	RMC1/16 105JATP	J24185105		1-	A	C3
R 4716	CHIP RES.	1M	1/16W	5%	RMC1/16 105JATP	J24185105		1-	A	C3
R 4717	CHIP RES.	47k	1/16W	5%	RMC1/16 473JATP	J24185473		1-	A	A1
R 4718	CHIP RES.	47k	1/16W	5%	RMC1/16 473JATP	J24185473		1-	A	A1
R 4719	CHIP RES.	47k	1/16W	5%	RMC1/16 473JATP	J24185473		1-	A	A1
R 4720	CHIP RES.	47k	1/16W	5%	RMC1/16 473JATP	J24185473		1-	A	A3
R 4721	CHIP RES.	4.7k	1/16W	5%	RMC1/16 472JATP	J24185472		1-	A	I2
R 4722	CHIP RES.	100k	1/16W	5%	RMC1/16 104JATP	J24185104		1-	A	I2
R 4723	CHIP RES.	4.7k	1/16W	5%	RMC1/16 472JATP	J24185472		1-	A	H2
R 4725	CHIP RES.	4.7k	1/16W	5%	RMC1/16 472JATP	J24185472		1-	A	H3
R 4727	CHIP RES.	4.7k	1/16W	5%	RMC1/16 472JATP	J24185472		1-	A	H3
R 4729	CHIP RES.	0	1/16W	5%	RMC1/16 000JATP	J24185000		1-	A	H2
R 4730	CHIP RES.	10k	1/16W	5%	RMC1/16 103JATP	J24185103		1-	A	H2
R 4731	CHIP RES.	0	1/16W	5%	RMC1/16 000JATP	J24185000		1-	A	H2
R 4732	CHIP RES.	0	1/16W	5%	RMC1/16 000JATP	J24185000		1-	A	H2
R 4733	CHIP RES.	0	1/16W	5%	RMC1/16 000JATP	J24185000		1-	A	H2
R 4734	CHIP RES.	0	1/16W	5%	RMC1/16 000JATP	J24185000		1-	A	H3
R 4735	CHIP RES.	4.7k	1/16W	5%	RMC1/16 472JATP	J24185472		1-	A	H2

REF	DESCRIPTION	VALUE	V/W	TOL.	MFR'S DESIG	VXSTD P/N	VERS.	LOT	SIDE	LAY ADR
R 4736	CHIP RES.	10k	1/16W	5%	RMC1/16 103JATP	J24185103		1-	A	H3
R 4737	CHIP RES.	47k	1/16W	5%	RMC1/16 473JATP	J24185473		1-	A	G1
R 4738	CHIP RES.	10k	1/16W	5%	RMC1/16 103JATP	J24185103		1-	A	H3
R 4739	CHIP RES.	47k	1/16W	5%	RMC1/16 473JATP	J24185473		1-	A	F1
R 4740	CHIP RES.	10k	1/16W	5%	RMC1/16 103JATP	J24185103		1-	A	H3
R 4742	CHIP RES.	0	1/16W	5%	RMC1/16 000JATP	J24185000		1-	A	H3
R 4744	CHIP RES.	10k	1/16W	5%	RMC1/16 103JATP	J24185103		1-	A	H3
R 4745	CHIP RES.	47k	1/16W	5%	RMC1/16 473JATP	J24185473		1-	A	H3
R 4746	CHIP RES.	4.7k	1/16W	5%	RMC1/16 472JATP	J24185472		1-	A	I1
R 4748	CHIP RES.	0	1/16W	5%	RMC1/16 000JATP	J24185000		1-	A	H2
R 4750	CHIP RES.	0	1/16W	5%	RMC1/16 000JATP	J24185000		1-	A	H2
R 4751	CHIP RES.	0	1/16W	5%	RMC1/16 000JATP	J24185000		1-	A	H2
R 4752	CHIP RES.	10k	1/16W	5%	RMC1/16 103JATP	J24185103		1-	A	H2
R 4753	CHIP RES.	10k	1/16W	5%	RMC1/16 103JATP	J24185103		1-	A	I2
R 4754	CHIP RES.	10k	1/16W	5%	RMC1/16 103JATP	J24185103		1-	A	I2
R 4755	CHIP RES.	10k	1/16W	5%	RMC1/16 103JATP	J24185103		1-	A	H3
R 4756	CHIP RES.	10k	1/16W	5%	RMC1/16 103JATP	J24185103		1-	A	H3
R 4757	CHIP RES.	10k	1/16W	5%	RMC1/16 103JATP	J24185103		1-	A	H3
R 4758	CHIP RES.	10k	1/16W	5%	RMC1/16 103JATP	J24185103		1-	A	H3
R 4759	CHIP RES.	10k	1/16W	5%	RMC1/16 103JATP	J24185103		1-	A	H3
R 4760	CHIP RES.	10k	1/16W	5%	RMC1/16 103JATP	J24185103		1-	A	I3
R 4761	CHIP RES.	10k	1/16W	5%	RMC1/16 103JATP	J24185103		1-	A	I3
R 4762	CHIP RES.	10k	1/16W	5%	RMC1/16 103JATP	J24185103		1-	A	I3
R 4763	CHIP RES.	10k	1/16W	5%	RMC1/16 103JATP	J24185103		1-	A	I3
R 4764	CHIP RES.	10k	1/16W	5%	RMC1/16 103JATP	J24185103		1-	A	I3
R 4765	CHIP RES.	4.7k	1/16W	5%	RMC1/16 472JATP	J24185472		1-	A	I1
R 4767	CHIP RES.	4.7k	1/16W	5%	RMC1/16 472JATP	J24185472		1-	A	I1
R 4769	CHIP RES.	4.7k	1/16W	5%	RMC1/16 472JATP	J24185472		1-	A	I1
R 4771	CHIP RES.	4.7k	1/16W	5%	RMC1/16 472JATP	J24185472		1-	A	I1
R 4773	CHIP RES.	47k	1/16W	5%	RMC1/16 473JATP	J24185473		1-	A	H2
R 4775	CHIP RES.	100k	1/16W	5%	RMC1/16 104JATP	J24185104		1-	A	H3
R 4778	CHIP RES.	100k	1/16W	5%	RMC1/16 104JATP	J24185104		1-	A	J2
R 4779	CHIP RES.	10k	1/16W	5%	RMC1/16 103JATP	J24185103		1-	A	I2
R 4780	CHIP RES.	10k	1/16W	5%	RMC1/16 103JATP	J24185103		1-	A	I2
R 4781	CHIP RES.	10k	1/16W	5%	RMC1/16 103JATP	J24185103		1-	A	I2
R 4782	CHIP RES.	10k	1/16W	5%	RMC1/16 103JATP	J24185103		1-	A	I2
R 4783	CHIP RES.	10k	1/16W	5%	RMC1/16 103JATP	J24185103		1-	A	I2
R 4784	CHIP RES.	10k	1/16W	5%	RMC1/16 103JATP	J24185103		1-	A	I2
R 4785	CHIP RES.	10k	1/16W	5%	RMC1/16 103JATP	J24185103		1-	A	I2
R 4786	CHIP RES.	4.7k	1/16W	5%	RMC1/16 472JATP	J24185472		1-	A	I2
R 4787	CHIP RES.	10k	1/16W	5%	RMC1/16 103JATP	J24185103		1-	A	I3
R 4788	CHIP RES.	10k	1/16W	5%	RMC1/16 103JATP	J24185103		1-	A	I3
R 4789	CHIP RES.	10k	1/16W	5%	RMC1/16 103JATP	J24185103		1-	A	I3
R 4790	CHIP RES.	0	1/16W	5%	RMC1/16 000JATP	J24185000		1-	A	C2
R 4796	CHIP RES.	100k	1/16W	5%	RMC1/16 104JATP	J24185104		1-	A	H1
R 4798	CHIP RES.	100k	1/16W	5%	RMC1/16 104JATP	J24185104		1-	A	H1
R 4800	CHIP RES.	100k	1/16W	5%	RMC1/16 104JATP	J24185104		1-	A	H1
R 4802	CHIP RES.	100k	1/16W	5%	RMC1/16 104JATP	J24185104		1-	A	H1
R 4804	CHIP RES.	100k	1/16W	5%	RMC1/16 104JATP	J24185104		1-	A	J2
R 4806	CHIP RES.	100k	1/16W	5%	RMC1/16 104JATP	J24185104		1-	A	J2
R 4808	CHIP RES.	10k	1/16W	5%	RMC1/16 103JATP	J24185103		1-	A	I2
R 4809	CHIP RES.	10k	1/16W	5%	RMC1/16 103JATP	J24185103		1-	A	I2
R 4810	CHIP RES.	100k	1/16W	5%	RMC1/16 104JATP	J24185104		1-	A	I2
R 4811	CHIP RES.	10k	1/16W	5%	RMC1/16 103JATP	J24185103		1-	A	I2
R 4812	CHIP RES.	10k	1/16W	5%	RMC1/16 103JATP	J24185103		1-	A	I2
R 4813	CHIP RES.	10k	1/16W	5%	RMC1/16 103JATP	J24185103		1-	A	I2
R 4814	CHIP RES.	10k	1/16W	5%	RMC1/16 103JATP	J24185103		1-	A	I3
R 4815	CHIP RES.	100k	1/16W	5%	RMC1/16 104JATP	J24185104		1-	A	I3
R 4816	CHIP RES.	10k	1/16W	5%	RMC1/16 103JATP	J24185103		1-	A	I3
R 4817	CHIP RES.	100k	1/16W	5%	RMC1/16 104JATP	J24185104		1-	A	H3
R 4819	CHIP RES.	100k	1/16W	5%	RMC1/16 104JATP	J24185104		1-	A	H3
R 4821	CHIP RES.	100k	1/16W	5%	RMC1/16 104JATP	J24185104		1-	A	J1
R 4823	CHIP RES.	100k	1/16W	5%	RMC1/16 104JATP	J24185104		1-	A	J1
R 4825	CHIP RES.	0	1/16W	5%	RMC1/16 000JATP	J24185000		1-	A	F1
R 4826	CHIP RES.	0	1/16W	5%	RMC1/16 000JATP	J24185000		1-	A	F1
R 4829	CHIP RES.	0	1/16W	5%	RMC1/16 000JATP	J24185000		1-	A	C1
R 4830	CHIP RES.	10k	1/16W	5%	RMC1/16 103JATP	J24185103		1-	A	G3
R 4831	CHIP RES.	1k	1/16W	5%	RMC1/16 102JATP	J24185102		1-	A	B3
R 4832	CHIP RES.	1k	1/16W	5%	RMC1/16 102JATP	J24185102		1-	A	A3
R 4833	CHIP RES.	1k	1/16W	5%	RMC1/16 102JATP	J24185102		1-	A	B3
R 4834	CHIP RES.	1k	1/16W	5%	RMC1/16 102JATP	J24185102		1-	A	A3
R 4835	CHIP RES.	1k	1/16W	5%	RMC1/16 102JATP	J24185102		1-	A	A3
R 4836	CHIP RES.	1k	1/16W	5%	RMC1/16 102JATP	J24185102		1-	A	A3

CNTL Unit

Parts List

REF	DESCRIPTION	VALUE	V/W	TOL.	MFR'S DESIG	VXSTD P/N	VERS.	LOT	SIDE	LAY ADR
R 4837	CHIP RES.	1k	1/16W	5%	RMC1/16 102JATP	J24185102		1-	A	B3
R 4838	CHIP RES.	1k	1/16W	5%	RMC1/16 102JATP	J24185102		1-	A	B3
R 4839	CHIP RES.	1k	1/16W	5%	RMC1/16 102JATP	J24185102		1-	A	B3
R 4840	CHIP RES.	1k	1/16W	5%	RMC1/16 102JATP	J24185102		1-	A	A3
R 4841	CHIP RES.	1k	1/16W	5%	RMC1/16 102JATP	J24185102		1-	A	B3
R 4842	CHIP RES.	1k	1/16W	5%	RMC1/16 102JATP	J24185102		1-	A	A3
R 4843	CHIP RES.	1k	1/16W	5%	RMC1/16 102JATP	J24185102		1-	A	A3
R 4844	CHIP RES.	1k	1/16W	5%	RMC1/16 102JATP	J24185102		1-	A	A3
R 4845	CHIP RES.	1k	1/16W	5%	RMC1/16 102JATP	J24185102		1-	A	B3
R 4846	CHIP RES.	1k	1/16W	5%	RMC1/16 102JATP	J24185102		1-	A	B3
R 4847	CHIP RES.	1k	1/16W	5%	RMC1/16 102JATP	J24185102		1-	A	A3
R 4848	CHIP RES.	1k	1/16W	5%	RMC1/16 102JATP	J24185102		1-	A	A3
R 4849	CHIP RES.	1k	1/16W	5%	RMC1/16 102JATP	J24185102		1-	A	B3
R 4850	CHIP RES.	1k	1/16W	5%	RMC1/16 102JATP	J24185102		1-	A	A3
R 4851	CHIP RES.	1k	1/16W	5%	RMC1/16 102JATP	J24185102		1-	A	A3
R 4852	CHIP RES.	1k	1/16W	5%	RMC1/16 102JATP	J24185102		1-	A	C3
R 4853	CHIP RES.	1k	1/16W	5%	RMC1/16 102JATP	J24185102		1-	A	B3
R 4854	CHIP RES.	1k	1/16W	5%	RMC1/16 102JATP	J24185102		1-	A	A3
R 4855	CHIP RES.	1k	1/16W	5%	RMC1/16 102JATP	J24185102		1-	A	A3
R 4856	CHIP RES.	1k	1/16W	5%	RMC1/16 102JATP	J24185102		1-	A	B3
R 4857	CHIP RES.	1k	1/16W	5%	RMC1/16 102JATP	J24185102		1-	A	A3
R 4858	CHIP RES.	1k	1/16W	5%	RMC1/16 102JATP	J24185102		1-	A	A3
R 4859	CHIP RES.	47k	1/16W	5%	RMC1/16 473JATP	J24185473		1-	A	H3
R 4860	CHIP RES.	47k	1/16W	5%	RMC1/16 473JATP	J24185473		1-	A	H3
R 4861	CHIP RES.	47k	1/16W	5%	RMC1/16 473JATP	J24185473		1-	A	H3
R 4862	CHIP RES.	4.7k	1/10W	0.5%	RR1220P-472-D-T5	J24209187		1-	A	G4
R 4863	CHIP RES.	4.7k	1/10W	0.5%	RR1220P-472-D-T5	J24209187		1-	A	G4
R 4865	CHIP RES.	220	1/16W	5%	RMC1/16 221JATP	J24185221		1-	A	G2
R 4866	CHIP RES.	220	1/16W	5%	RMC1/16 221JATP	J24185221		1-	A	G2
R 4867	CHIP RES.	220	1/16W	5%	RMC1/16 221JATP	J24185221		1-	A	G2
R 4868	CHIP RES.	220	1/16W	5%	RMC1/16 221JATP	J24185221		1-	A	G2
R 4869	CHIP RES.	220	1/16W	5%	RMC1/16 221JATP	J24185221		1-	A	H2
R 4870	CHIP RES.	220	1/16W	5%	RMC1/16 221JATP	J24185221		1-	A	H2
R 4871	CHIP RES.	220	1/16W	5%	RMC1/16 221JATP	J24185221		1-	A	H2
R 4872	CHIP RES.	220	1/16W	5%	RMC1/16 221JATP	J24185221		1-	A	H2
R 4873	CHIP RES.	220	1/16W	5%	RMC1/16 221JATP	J24185221		1-	A	H2
R 4874	CHIP RES.	220	1/16W	5%	RMC1/16 221JATP	J24185221		1-	A	H2
R 4875	CHIP RES.	47	1/16W	5%	RMC1/16 470JATP	J24185470		1-	A	H2
R 4876	CHIP RES.	47	1/16W	5%	RMC1/16 470JATP	J24185470		1-	A	H2
R 4877	CHIP RES.	100	1/16W	5%	RMC1/16 101JATP	J24185101		1-	A	H2
R 4878	CHIP RES.	100	1/16W	5%	RMC1/16 101JATP	J24185101		1-	A	H2
R 4880	CHIP RES.	0	1/16W	5%	RMC1/16 000JATP	J24185000		1-	A	B2
R 4881	CHIP RES.	0	1/16W	5%	RMC1/16 000JATP	J24185000		1-	A	B2
R 4882	CHIP RES.	0	1/16W	5%	RMC1/16 000JATP	J24185000		1-	A	B2
R 4884	CHIP RES.	0	1/16W	5%	RMC1/16 000JATP	J24185000		1-	A	B2
R 4887	CHIP RES.	100k	1/16W	5%	RMC1/16 104JATP	J24185104		1-	A	J2
R 4888	CHIP RES.	100k	1/16W	5%	RMC1/16 104JATP	J24185104		1-	A	G2
R 4889	CHIP RES.	100k	1/16W	5%	RMC1/16 104JATP	J24185104		1-	A	H4
R 4890	CHIP RES.	10k	1/16W	5%	RMC1/16 103JATP	J24185103		1-	A	I3
R 4891	CHIP RES.	100k	1/16W	5%	RMC1/16 104JATP	J24185104		1-	A	G3
R 4892	CHIP RES.	100	1/16W	5%	RMC1/16 101JATP	J24185101		1-	A	G3
R 4893	CHIP RES.	100	1/16W	5%	RMC1/16 101JATP	J24185101		1-	A	G3
R 4894	CHIP RES.	100	1/16W	5%	RMC1/16 101JATP	J24185101		1-	A	G3
R 4895	CHIP RES.	100k	1/16W	5%	RMC1/16 104JATP	J24185104		1-	A	H3
R 4896	CHIP RES.	10k	1/16W	5%	RMC1/16 103JATP	J24185103		1-	A	I2
R 4897	CHIP RES.	10k	1/16W	5%	RMC1/16 103JATP	J24185103		1-	A	G2
R 4898	CHIP RES.	10k	1/16W	5%	RMC1/16 103JATP	J24185103		1-	A	H3
R 4899	CHIP RES.	100k	1/16W	5%	RMC1/16 104JATP	J24185104		1-	A	H2
R 4902	CHIP RES.	100k	1/16W	5%	RMC1/16 104JATP	J24185104		1-	A	H2
R 4903	CHIP RES.	0	1/16W	5%	RMC1/16 000JATP	J24185000		1-	A	B2
R 4904	CHIP RES.	22	1W	5%	RMC1 220JTE	J24305220		1-	A	C1
R 4905	CHIP RES.	0	1/16W	5%	RMC1/16 000JATP	J24185000		1-	A	J2
R 4906	CHIP RES.	0	1/16W	5%	RMC1/16 000JATP	J24185000		1-	A	J2
R 4907	CHIP RES.	3.3k	1/16W	5%	RMC1/16 332JATP	J24185332		1-	A	I2
R 4909	CHIP RES.	10k	1/16W	5%	RMC1/16 103JATP	J24185103		1-	A	H3
S 4502	SLIDE SWITCH				SSSS222700	N6090057		1-	A	J3
X 4501	XTAL SMD-49	11.1MHZ			11.10MHZ	H0103321		1-	A	H1
	COVER				(P1091233)	RA1266600	W/ CE LABEL		8-	
	COVER				(N6090057)	RA1267800	W/ CE LABEL		8-	
	COVER				(P0091409)	RA1266700	W/ CE LABEL		8-	
	COVER				(P1091132)	RA1266800	W/ CE LABEL		8-	
	COVER				(P1091244)	RA1266900	W/ CE LABEL		8-	

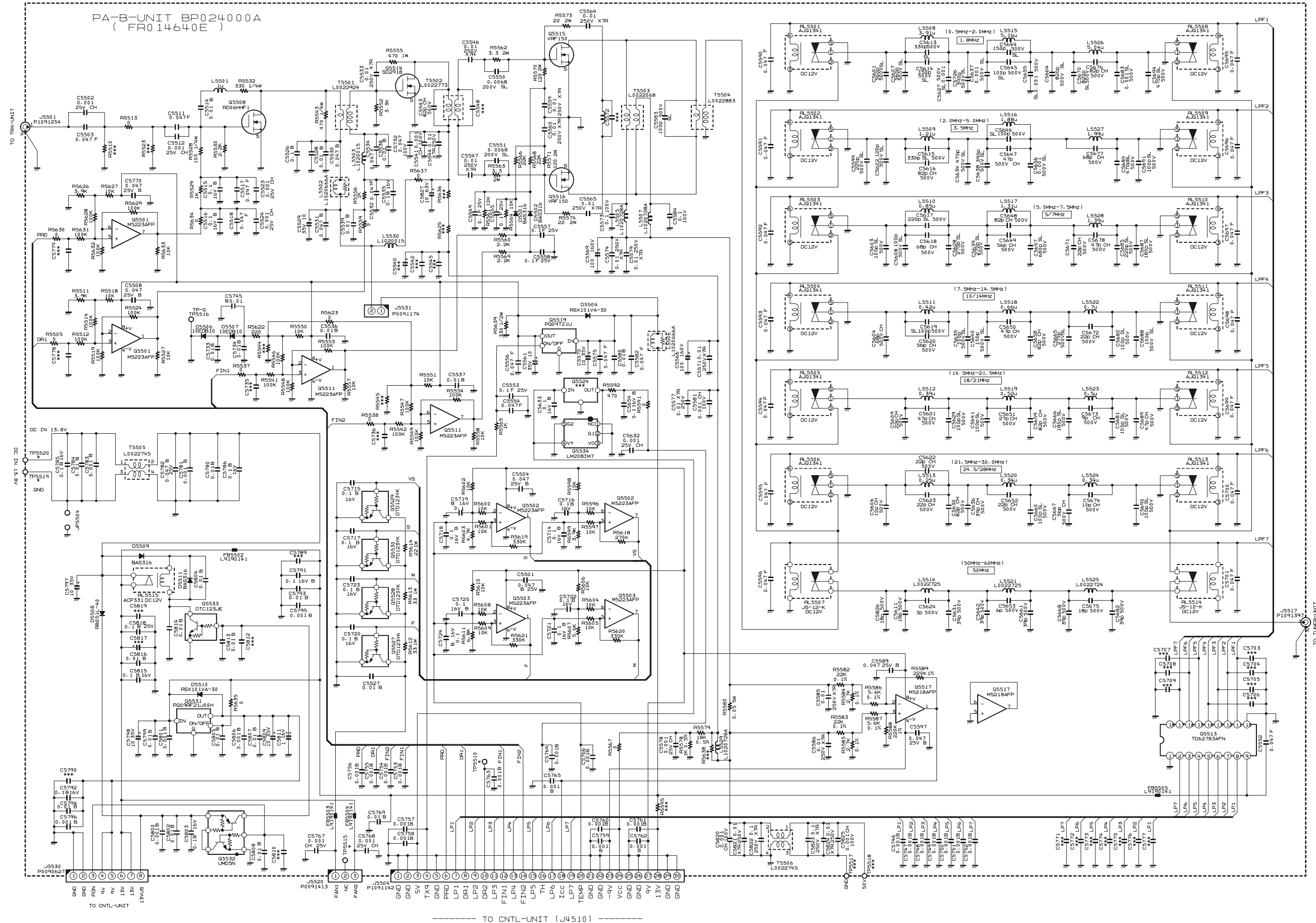

PA-B Unit

Note

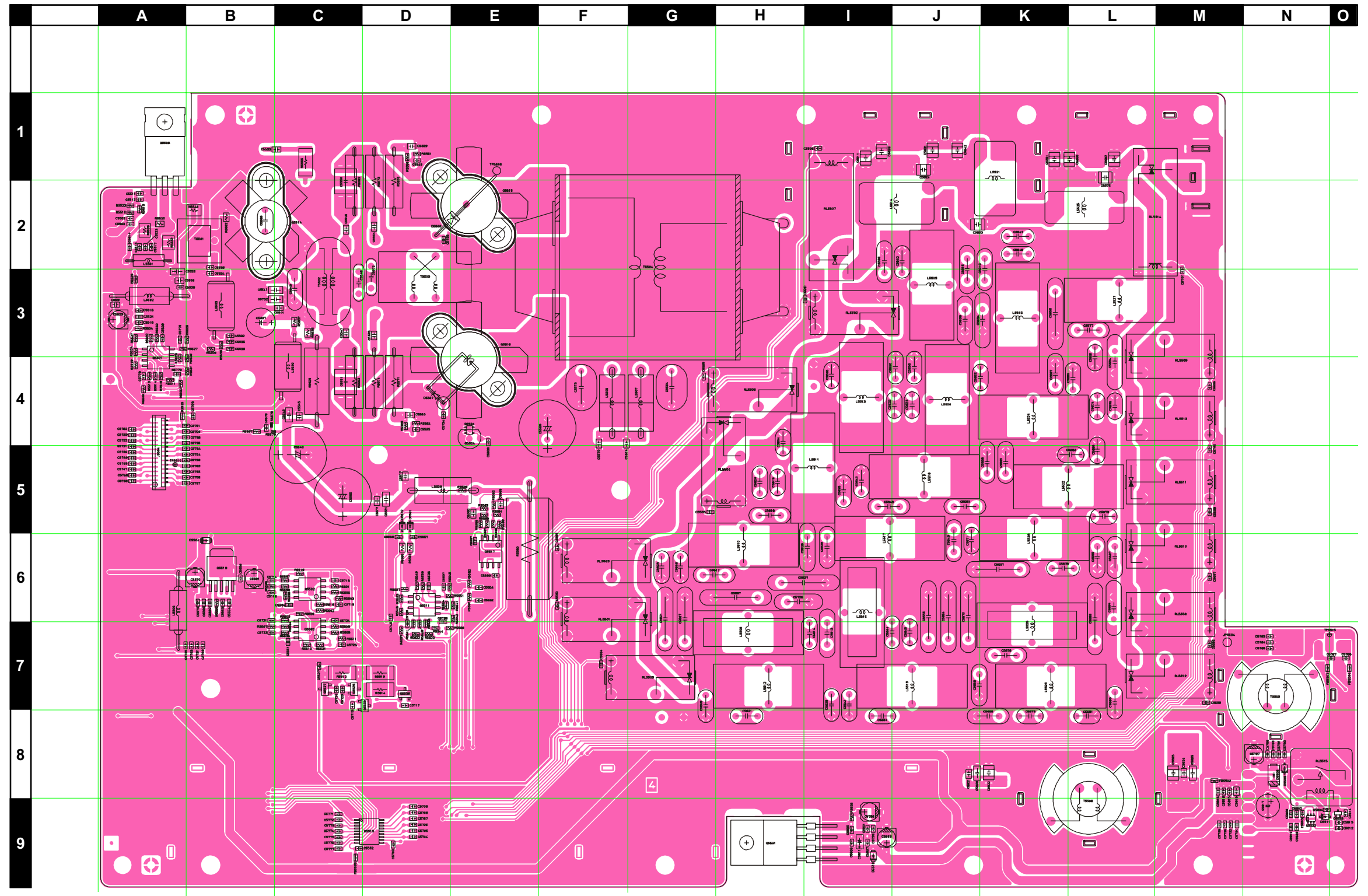
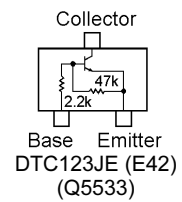
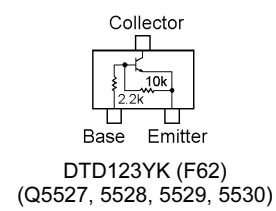
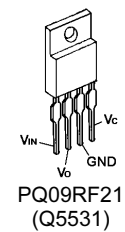
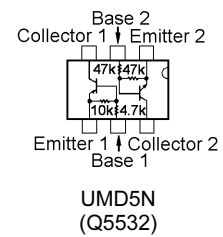
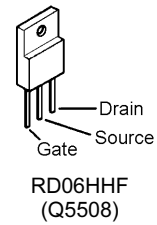
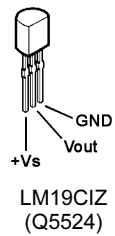
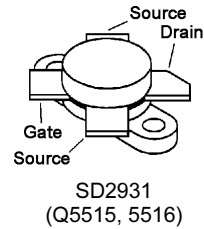
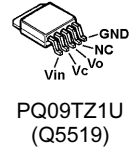
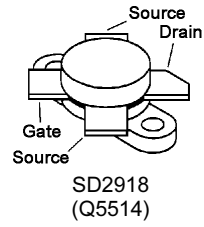
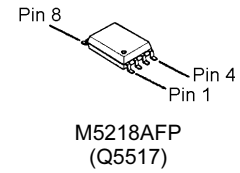
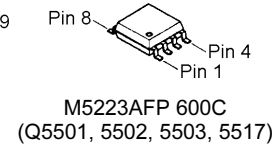
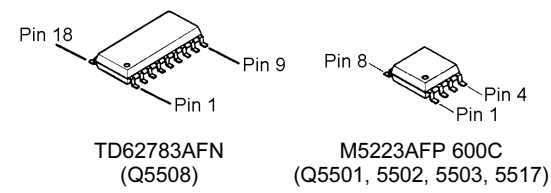

PA-B Unit

Parts Layout (Side B)

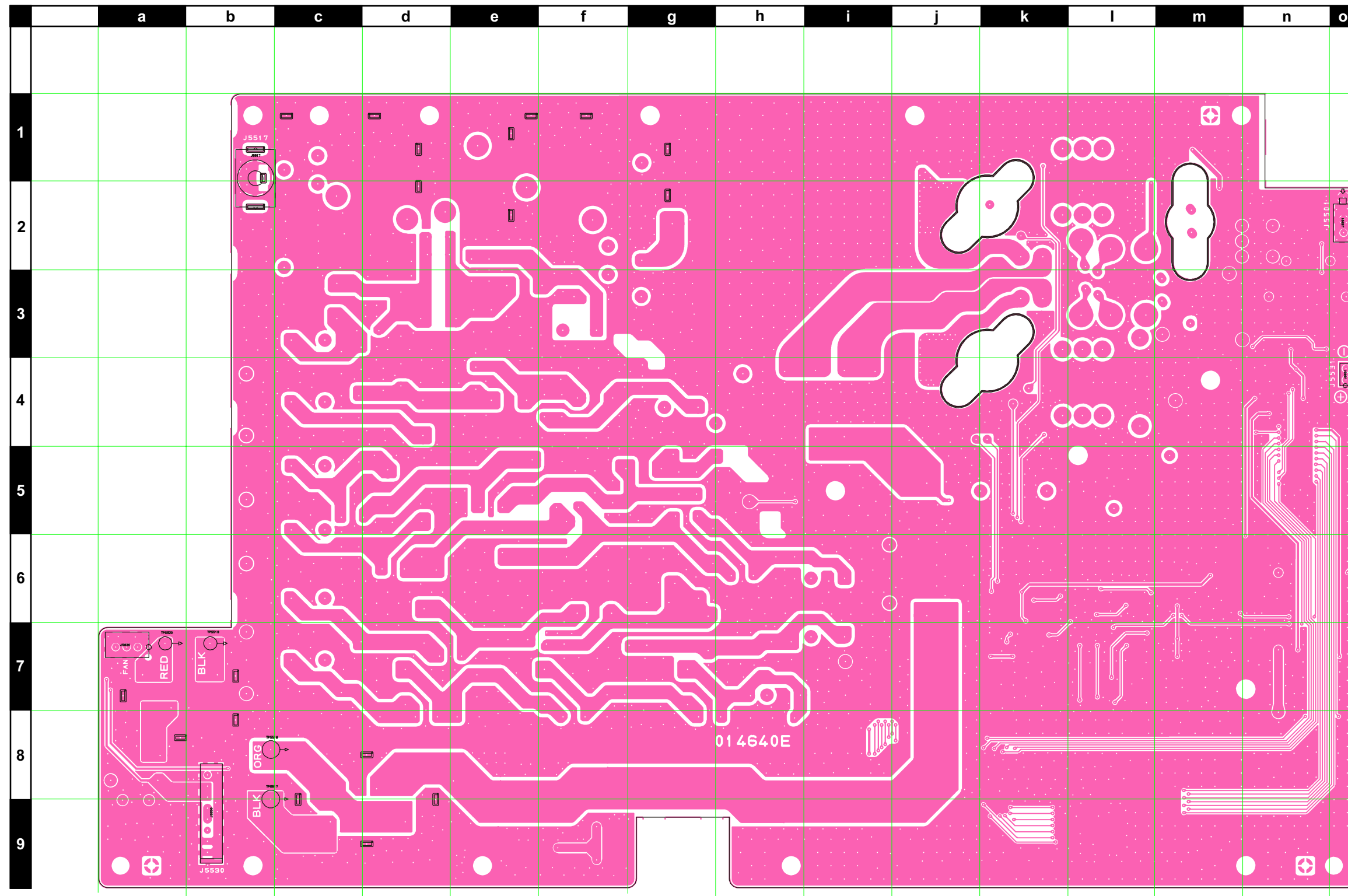

PA-B Unit

Parts List

REF	DESCRIPTION	VALUE	V/W	TOL.	MFR'S DESIG	VXSTD P/N	VERS.	LOT	SIDE	LAY ADR
PCB with Components						CS2078101				
	Printed Circuit Board					FR014640E		1-		
C 5501	CHIP CAP.	0.047uF	25V	B	GRM188B11E473KA01D	K22144811		1-	A	C7
C 5502	CHIP CAP.	0.001uF	25V	CH	GRM1882C1E102JA01D	K22144204		1-	A	A2
C 5503	CHIP CAP.	0.047uF	50V	F	GRM188F11H473ZA01D	K22175001		1-	A	A2
C 5504	CHIP CAP.	0.047uF	25V	B	GRM188B11E473KA01D	K22144811		1-	A	C6
C 5508	CHIP CAP.	0.047uF	25V	B	GRM188B11E473KA01D	K22144811		1-	A	A3
C 5511	CHIP CAP.	0.047uF	50V	F	GRM188F11H473ZA01D	K22175001		1-	A	A2
C 5512	CHIP CAP.	0.001uF	25V	CH	GRM1882C1E102JA01D	K22144204		1-	A	A2
C 5514	CHIP CAP.	0.01uF	50V	B	GRM188B11H103JA01D	K22174824		1-	A	A2
C 5515	CHIP CAP.	0.1uF	16V	B	GRM188B11C104KA01D	K22124805		1-	A	A2
C 5516	CHIP CAP.	0.1uF	16V	B	GRM188B11C104KA01D	K22124805		1-	A	A3
C 5517	CHIP CAP.	0.047uF	50V	F	GRM188F11H473ZA01D	K22175001		1-	A	A2
C 5518	CHIP CAP.	0.047uF	50V	F	GRM188F11H473ZA01D	K22175001		1-	A	A3
C 5523	CHIP CAP.	0.001uF	25V	CH	GRM1882C1E102JA01D	K22144204		1-	A	A2
C 5524	CHIP CAP.	0.001uF	25V	CH	GRM1882C1E102JA01D	K22144204		1-	A	A3
C 5526	CHIP CAP.	0.1uF	50V	B	GRM42-6B104K50PT	K22171820		1-	A	A3
C 5527	CHIP CAP.	0.01uF	50V	B	GRM188B11H103KA01D	K22174823		1-	A	C7
C 5528	CHIP CAP.	0.01uF	50V	B	GRM188B11H103JA01D	K22174824		1-	A	A3
C 5529	AL.ELECTRO.CAP.	10uF	35V		EEE1VA100WR	K48160006		1-	A	A3
C 5530	CHIP CAP.	0.047uF	50V	B	GRM21BB11H473KA01L	K22170823		1-	A	A3
C 5531	CHIP CAP.	0.047uF	50V	B	GRM21BB11H473KA01L	K22170823		1-	A	A3
C 5532	CHIP CAP.	0.047uF	50V	F	GRM188F11H473ZA01D	K22175001		1-	A	B3
C 5533	CHIP CAP.	0.01uF	250V	X7R	GRM21BR72E103KW03L	K22240801		1-	A	B1
C 5534	CHIP CAP.	0.047uF	50V	F	GRM188F11H473ZA01D	K22175001		1-	A	B3
C 5535	CHIP CAP.	0.1uF	16V	B	GRM188B11C104KA01D	K22124805		1-	A	B3
C 5536	CHIP CAP.	0.01uF	50V	B	GRM188B11H103KA01D	K22174823		1-	A	D6
C 5537	CHIP CAP.	0.01uF	50V	B	GRM188B11H103KA01D	K22174823		1-	A	D6
C 5538	CHIP CAP.	0.01uF	50V	B	GRM188B11H103JA01D	K22174824		1-	A	B2
C 5539	CHIP CAP.	0.01uF	50V	B	GRM188B11H103JA01D	K22174824		1-	A	B3
C 5541	CHIP CAP.	0.001uF	100V	CH	GRM31M2C2A102JZ01L	K22201202		1-	A	B3
C 5543	CERAMIC CAP.	82pF	500V	CH	RT-HM95SKCH820J	K26270162		1-	A	C3
C 5544	CHIP CAP.	0.01uF	250V	X7R	GRM21BR72E103KW03L	K22240801		1-	A	C3
C 5546	CHIP CAP.	0.01uF	250V	X7R	GRM21BR72E103KW03L	K22240801		1-	A	C2
C 5547	CHIP CAP.	0.01uF	250V	X7R	GRM21BR72E103KW03L	K22240801		1-	A	C3
C 5549	CHIP CAP.	0.1uF	25V	F	GRM188F11E104ZA01D	K22145001		1-	A	D1
C 5550	CERAMIC CAP.	0.0068uF	200V	SL	GRM55R1X2D682JV01L	K22236101		1-	A	C2
C 5551	CERAMIC CAP.	0.0068uF	200V	SL	GRM55R1X2D682JV01L	K22236101		1-	A	C4
C 5552	CHIP CAP.	0.047uF	50V	F	GRM188F11H473ZA01D	K22175001		1-	A	C9
C 5553	CHIP CAP.	0.1uF	25V	F	GRM188F11E104ZA01D	K22145001		1-	A	B6
C 5554	CHIP CAP.	0.047uF	50V	F	GRM188F11H473ZA01D	K22175001		1-	A	B6
C 5555	CHIP CAP.	0.1uF	25V	F	GRM188F11E104ZA01D	K22145001		1-	A	D4
C 5556	CHIP CAP.	0.047uF	50V	F	GRM188F11H473ZA01D	K22175001		1-	A	B6
C 5557	CHIP CAP.	0.1uF	25V	F	GRM188F11E104ZA01D	K22145001		1-	A	D6
C 5558	CHIP CAP.	0.1uF	25V	F	GRM188F11E104ZA01D	K22145001		1-	A	D6
C 5559	CHIP CAP.	0.01uF	250V	X7R	GRM21BR72E103KW03L	K22240801		1-	A	D1
C 5560	CHIP CAP.	0.01uF	250V	X7R	GRM21BR72E103KW03L	K22240801		1-	A	D4
C 5561	AL.ELECTRO.CAP.	10uF	35V		EEE1VA100WR	K48160006		1-	A	B6
C 5564	CHIP CAP.	0.01uF	250V	X7R	GRM21BR72E103KW03L	K22240801		1-	A	D2
C 5565	CHIP CAP.	0.01uF	250V	X7R	GRM21BR72E103KW03L	K22240801		1-	A	D3
C 5566	AL.ELECTRO.CAP.	100uF	160V		RE3-160V101MI6#	K40229001		1-	A	C5
C 5569	AL.ELECTRO.CAP.	100uF	160V		RE3-160V101MI6#	K40229001		1-	A	F4
C 5570	AL.ELECTRO.CAP.	10uF	35V		EEE1VA100WR	K48160006		1-	A	B6
C 5571	CHIP CAP.	0.01uF	250V	X7R	GRM21BR72E103KW03L	K22240801		1-	A	D5
C 5573	FILM CAP.	0.1uF	100V		ECQ-B1104JF	K50205104		1	A	F4
C 5573	FILM CAP.	0.1uF	100V		ECQV1104JM	K52200002		2-	A	F4
C 5574	CHIP CAP.	0.01uF	250V	X7R	GRM21BR72E103KW03L	K22240801		1-	A	F4
C 5575	CHIP CAP.	0.047uF	50V	F	GRM188F11H473ZA01D	K22175001		1-	A	B6
C 5577	CHIP CAP.	0.01uF	250V	X7R	GRM21BR72E103KW03L	K22240801		1-	A	D5
C 5578	CHIP CAP.	0.001uF	25V	CH	GRM1882C1E102JA01D	K22144204		1-	A	B4
C 5579	CHIP CAP.	0.01uF	250V	X7R	GRM21BR72E103KW03L	K22240801		1-	A	F4
C 5580	CHIP CAP.	0.01uF	50V	B	GRM188B11H103JA01D	K22174824		1-	A	B6
C 5581	CHIP CAP.	0.001uF	100V	CH	GRM31M2C2A102JZ01L	K22201202		1-	A	D5
C 5582	CHIP CAP.	0.047uF	50V	F	GRM188F11H473ZA01D	K22175001		1-	A	B6
C 5583	CERAMIC CAP.	100pF	500V	SL	RT-HM60SKSL101J	K26270057		1-	A	B2
C 5584	FILM CAP.	0.1uF	100V		ECQ-B1104JF	K50205104		1	A	G4
C 5584	FILM CAP.	0.1uF	100V		ECQV1104JM	K52200002		2-	A	G4
C 5585	CHIP CAP.	0.01uF	250V	X7R	GRM21BR72E103KW03L	K22240801		1-	A	E5
C 5586	CHIP CAP.	0.01uF	250V	X7R	GRM21BR72E103KW03L	K22240801		1-	A	E5
C 5589	CHIP CAP.	0.047uF	25V	B	GRM188B11E473KA01D	K22144811		1-	A	E6
C 5590	CHIP CAP.	0.047uF	50V	F	GRM188F11H473ZA01D	K22175001		1-	A	F6
C 5591	CHIP CAP.	0.047uF	50V	F	GRM188F11H473ZA01D	K22175001		1-	A	H3
C 5592	CHIP CAP.	0.047uF	50V	F	GRM188F11H473ZA01D	K22175001		1-	A	F6

PA-B Unit

Parts List

REF	DESCRIPTION	VALUE	V/W	TOL.	MFR'S DESIG	VXSTD P/N	VERS.	LOT	SIDE	LAY ADR
C 5593	CHIP CAP.	0.047uF	50V	F	GRM188F11H473ZA01D	K22175001		1-	A	G5
C 5594	CHIP CAP.	0.047uF	50V	F	GRM188F11H473ZA01D	K22175001		1-	A	F7
C 5595	CHIP CAP.	0.047uF	50V	F	GRM188F11H473ZA01D	K22175001		1-	A	G4
C 5596	CHIP CAP.	0.047uF	50V	F	GRM188F11H473ZA01D	K22175001		1-	A	I1
C 5597	CHIP CAP.	0.047uF	25V	B	GRM188B11E473KA01D	K22144811		1-	A	E6
C 5599	CERAMIC CAP.	220pF	500V	SL	RT-HM95SKSL221J	K26270061		1-	A	I2
C 5601	CERAMIC CAP.	560pF	500V	SL	HM15SJSL561J	K00279025		1-	A	G6
C 5602	CERAMIC CAP.	120pF	500V	SL	RT-HM74SKSL121J	K26270058		1-	A	J2
C 5603	CERAMIC CAP.	100pF	500V	SL	RT-HM60SKSL101J	K26270057		1-	A	G6
C 5604	CERAMIC CAP.	68pF	500V	CH	RT-HM95SKCH680J	K26270161		1-	A	H4
C 5606	CERAMIC CAP.	10pF	500V	CH	RT-HM60SKCH100D	K26270151		1-	A	I4
C 5607	CERAMIC CAP.	560pF	500V	SL	HM15SJSL561J	K00279025		1-	A	G6
C 5608	CERAMIC CAP.	100pF	500V	SL	RT-HM60SKSL101J	K26270057		1-	A	G6
C 5609	CERAMIC CAP.	22pF	500V	CH	RT-HM60SKCH220J	K26270155		1-	A	G8
C 5611	FILM CAP.	18pF	500V		UC232H0180J-T	K33279029		1-	A	I1
C 5613	CERAMIC CAP.	330pF	500V	SL	RT-HM11SKSL331J	K26270063		1-	A	I7
C 5614	CERAMIC CAP.	150pF	500V	SL	RT-HM74SKSL151J	K26270059		1-	A	I7
C 5615	CERAMIC CAP.	330pF	500V	SL	RT-HM11SKSL331J	K26270063		1-	A	J2
C 5616	CERAMIC CAP.	82pF	500V	CH	RT-HM95SKCH820J	K26270162		1-	A	K2
C 5617	CERAMIC CAP.	220pF	500V	SL	RT-HM95SKSL221J	K26270061		1-	A	G6
C 5618	CERAMIC CAP.	68pF	500V	CH	RT-HM95SKCH680J	K26270161		1-	A	H5
C 5619	CERAMIC CAP.	100pF	500V	SL	RT-HM60SKSL101J	K26270057		1-	A	H5
C 5620	CERAMIC CAP.	56pF	500V	CH	RT-HM95SKCH560J	K26270160		1-	A	H5
C 5621	CERAMIC CAP.	47pF	500V	CH	RT-HM74SKCH470J	K26270159		1-	A	H8
C 5622	CERAMIC CAP.	22pF	500V	CH	RT-HM60SKCH220J	K26270155		1-	A	J4
C 5623	CERAMIC CAP.	22pF	500V	CH	RT-HM60SKCH220J	K26270155		1-	A	J4
C 5624	FILM CAP.	3pF	500V		UC232H0030D-T	K33279027		1-	A	J1
C 5627	CERAMIC CAP.	0.001uF	500V	SL	HM17SJSL102J	K00279028		1-	A	H6
C 5628	CERAMIC CAP.	270pF	500V	SL	RT-HM95SKSL271J	K26270062		1-	A	I6
C 5629	CERAMIC CAP.	100pF	500V	SL	RT-HM60SKSL101J	K26270057		1-	A	I8
C 5630	CERAMIC CAP.	82pF	500V	CH	RT-HM95SKCH820J	K26270162		1-	A	J3
C 5631	FILM CAP.	39pF	500V		UC232H0390J-T	K33279038		1-	A	J1
C 5632	CHIP CAP.	0.001uF	25V	CH	GRM1882C1E102JA01D	K22144204		1-	A	E6
C 5633	CHIP CAP.	0.1uF	16V	B	GRM188B11C104KA01D	K22124805		1-	A	E4
C 5634	CERAMIC CAP.	470pF	500V	SL	HM13SJSL471J	K00279024		1-	A	K3
C 5635	CERAMIC CAP.	100pF	500V	SL	RT-HM60SKSL101J	K26270057		1-	A	I5
C 5636	CERAMIC CAP.	39pF	500V	CH	RT-HM74SKCH390J	K26270158		1-	A	J3
C 5637	CERAMIC CAP.	0.001uF	500V	SL	HM17SJSL102J	K00279028		1-	A	H6
C 5638	CERAMIC CAP.	390pF	500V	SL	RT-HM11SKSL391J	K26270064		1-	A	J3
C 5639	CERAMIC CAP.	270pF	500V	SL	RT-HM95SKSL271J	K26270062		1-	A	I6
C 5640	CERAMIC CAP.	150pF	500V	SL	RT-HM74SKSL151J	K26270059		1-	A	I5
C 5641	CERAMIC CAP.	100pF	500V	SL	RT-HM60SKSL101J	K26270057		1-	A	I8
C 5642	FILM CAP.	39pF	500V		UC232H0390J-T	K33279038		1-	A	J1
C 5644	CERAMIC CAP.	150pF	500V	SL	RT-HM74SKSL151J	K26270059		1-	A	I7
C 5645	CERAMIC CAP.	100pF	500V	SL	RT-HM60SKSL101J	K26270057		1-	A	J7
C 5646	CERAMIC CAP.	150pF	500V	SL	RT-HM74SKSL151J	K26270059		1-	A	K2
C 5647	CERAMIC CAP.	47pF	500V	CH	RT-HM74SKCH470J	K26270159		1-	A	K2
C 5648	CERAMIC CAP.	82pF	500V	CH	RT-HM95SKCH820J	K26270162		1-	A	I5
C 5649	CERAMIC CAP.	56pF	500V	CH	RT-HM95SKCH560J	K26270160		1-	A	J6
C 5650	CERAMIC CAP.	47pF	500V	CH	RT-HM74SKCH470J	K26270159		1-	A	J5
C 5651	CERAMIC CAP.	27pF	500V	CH	RT-HM60SKCH270J	K26270156		1-	A	I8
C 5652	CERAMIC CAP.	22pF	500V	CH	RT-HM60SKCH220J	K26270155		1-	A	J4
C 5653	FILM CAP.	6pF	500V		UC232H0060D-T	K33279045		1-	A	J2
C 5654	CHIP CAP.	0.1uF	16V	B	GRM188B11C104KA01D	K22124805		1-	A	E6
C 5655	CERAMIC CAP.	0.001uF	500V	SL	HM17SJSL102J	K00279028		1-	A	J6
C 5656	CERAMIC CAP.	0.001uF	500V	SL	HM17SJSL102J	K00279028		1-	A	K3
C 5657	CERAMIC CAP.	680pF	500V	SL	HM15SJSL681J	K00279026		1-	A	J6
C 5658	CERAMIC CAP.	82pF	500V	CH	RT-HM95SKCH820J	K26270162		1-	A	K5
C 5659	CERAMIC CAP.	82pF	500V	CH	RT-HM95SKCH820J	K26270162		1-	A	J7
C 5660	CERAMIC CAP.	100pF	500V	SL	RT-HM60SKSL101J	K26270057		1-	A	L4
C 5661	FILM CAP.	39pF	500V		UC232H0390J-T	K33279038		1-	A	K1
C 5664	CERAMIC CAP.	820pF	500V	SL	HM17SJSL821J	K00279027		1-	A	J6
C 5665	CERAMIC CAP.	270pF	500V	SL	RT-HM95SKSL271J	K26270062		1-	A	K5
C 5666	CERAMIC CAP.	180pF	500V	SL	RT-HM95SKSL181J	K26270060		1-	A	J8
C 5667	CERAMIC CAP.	56pF	500V	CH	RT-HM95SKCH560J	K26270160		1-	A	K4
C 5668	FILM CAP.	39pF	500V		UC232H0390J-T	K33279038		1-	A	K1
C 5670	CERAMIC CAP.	820pF	500V	SL	HM17SJSL821J	K00279027		1-	A	J6
C 5671	CERAMIC CAP.	22pF	500V	CH	RT-HM60SKCH220J	K26270155		1-	A	J6
C 5672	CERAMIC CAP.	22pF	500V	CH	RT-HM60SKCH220J	K26270155		1-	A	L5
C 5673	CERAMIC CAP.	9pF	500V	CH	RT-HM60SKCH090D	K26270150		1-	A	K8
C 5674	CERAMIC CAP.	10pF	500V	CH	RT-HM60SKCH100D	K26270151		1-	A	L4
C 5675	FILM CAP.	18pF	500V		UC232H0180J-T	K33279029		1-	A	L1
C 5676	CERAMIC CAP.	82pF	500V	CH	RT-HM95SKCH820J	K26270162		1-	A	K7

PA-B Unit

Parts List

REF	DESCRIPTION	VALUE	V/W	TOL.	MFR'S DESIG	VXSTD P/N	VERS.	LOT	SIDE	LAY ADR
C 5677	CERAMIC CAP.	68pF	500V	CH	RT-HM95SKCH680J	K26270161		1-	A	L3
C 5678	CERAMIC CAP.	47pF	500V	CH	RT-HM74SKCH470J	K26270159		1-	A	K6
C 5680	CERAMIC CAP.	100pF	500V	SL	RT-HM60SKSL101J	K26270057		1-	A	K5
C 5681	CERAMIC CAP.	100pF	500V	SL	RT-HM60SKSL101J	K26270057		1-	A	L8
C 5682	FILM CAP.	39pF	500V		UC232H0390J-T	K33279038		1-	A	L1
C 5683	CERAMIC CAP.	0.001uF	500V	SL	HM17SJSJL102J	K00279028		1-	A	L6
C 5684	CERAMIC CAP.	470pF	500V	SL	HM13SJSJL471J	K00279024		1-	A	L4
C 5685	CERAMIC CAP.	220pF	500V	SL	RT-HM95SKSL221J	K26270061		1-	A	L6
C 5687	CERAMIC CAP.	180pF	500V	SL	RT-HM95SKSL181J	K26270060		1-	A	L6
C 5688	CERAMIC CAP.	100pF	500V	SL	RT-HM60SKSL101J	K26270057		1-	A	L4
C 5689	CERAMIC CAP.	47pF	500V	CH	RT-HM74SKCH470J	K26270159		1-	A	L8
C 5690	CERAMIC CAP.	100pF	500V	SL	RT-HM60SKSL101J	K26270057		1-	A	L4
C 5691	CERAMIC CAP.	100pF	500V	SL	RT-HM60SKSL101J	K26270057		1-	A	L4
C 5694	CERAMIC CAP.	470pF	500V	SL	HM13SJSJL471J	K00279024		1-	A	L6
C 5695	CHIP CAP.	0.047uF	50V	F	GRM188F11H473ZA01D	K22175001		1-	A	M7
C 5696	CHIP CAP.	0.047uF	50V	F	GRM188F11H473ZA01D	K22175001		1-	A	M4
C 5697	CHIP CAP.	0.047uF	50V	F	GRM188F11H473ZA01D	K22175001		1-	A	M6
C 5698	CHIP CAP.	0.047uF	50V	F	GRM188F11H473ZA01D	K22175001		1-	A	M5
C 5699	CHIP CAP.	0.047uF	50V	F	GRM188F11H473ZA01D	K22175001		1-	A	M7
C 5700	CHIP CAP.	0.047uF	50V	F	GRM188F11H473ZA01D	K22175001		1-	A	M5
C 5701	CHIP CAP.	0.047uF	50V	F	GRM188F11H473ZA01D	K22175001		1-	A	M3
C 5714	CHIP CAP.	0.1uF	16V	B	GRM188B11C104KA01D	K22124805		1-	A	B6
C 5715	CHIP CAP.	0.1uF	16V	B	GRM188B11C104KA01D	K22124805		1-	A	C7
C 5716	CHIP CAP.	0.1uF	16V	B	GRM188B11C104KA01D	K22124805		1-	A	B6
C 5717	CHIP CAP.	0.1uF	16V	B	GRM188B11C104KA01D	K22124805		1-	A	D7
C 5718	CHIP CAP.	0.1uF	16V	B	GRM188B11C104KA01D	K22124805		1-	A	C6
C 5719	CHIP CAP.	0.1uF	16V	B	GRM188B11C104KA01D	K22124805		1-	A	C6
C 5720	CHIP CAP.	0.1uF	16V	B	GRM188B11C104KA01D	K22124805		1-	A	C7
C 5721	CHIP CAP.	0.1uF	16V	B	GRM188B11C104KA01D	K22124805		1-	A	B6
C 5722	CHIP CAP.	0.1uF	16V	B	GRM188B11C104KA01D	K22124805		1-	A	B7
C 5723	CHIP CAP.	0.1uF	16V	B	GRM188B11C104KA01D	K22124805		1-	A	C7
C 5724	CHIP CAP.	0.1uF	16V	B	GRM188B11C104KA01D	K22124805		1-	A	C6
C 5725	CHIP CAP.	0.1uF	16V	B	GRM188B11C104KA01D	K22124805		1-	A	C7
C 5726	CERAMIC CAP.	390pF	500V	SL	RT-HM11SKSL391J	K26270064		1-	A	I6
C 5732	CHIP CAP.	0.047uF	100V	X7R	GRM31MR72A473KA01L	K22201801		1-	A	B3
C 5733	CHIP CAP.	0.01uF	50V	B	GRM188B11H103KA01D	K22174823		1-	A	D2
C 5734	CHIP CAP.	0.01uF	50V	B	GRM188B11H103KA01D	K22174823		1-	A	D4
C 5745	CHIP CAP.	0.01uF	50V	B	GRM188B11H103KA01D	K22174823		1-	A	D6
C 5746	CHIP CAP.	0.001uF	50V	B	GRM188B11H102KA01D	K22174821		1-	A	A5
C 5747	CHIP CAP.	0.001uF	50V	B	GRM188B11H102KA01D	K22174821		1-	A	A5
C 5748	CHIP CAP.	0.001uF	50V	B	GRM188B11H102KA01D	K22174821		1-	A	A5
C 5749	CHIP CAP.	0.001uF	50V	B	GRM188B11H102KA01D	K22174821		1-	A	A5
C 5750	CHIP CAP.	0.001uF	50V	B	GRM188B11H102KA01D	K22174821		1-	A	A5
C 5751	CHIP CAP.	0.001uF	50V	B	GRM188B11H102KA01D	K22174821		1-	A	A5
C 5752	CHIP CAP.	0.001uF	50V	B	GRM188B11H102KA01D	K22174821		1-	A	A4
C 5753	CHIP CAP.	0.001uF	50V	B	GRM188B11H102KA01D	K22174821		1-	A	A5
C 5754	CHIP CAP.	0.001uF	50V	B	GRM188B11H102KA01D	K22174821		1-	A	A5
C 5755	CHIP CAP.	0.001uF	50V	B	GRM188B11H102KA01D	K22174821		1-	A	A5
C 5756	CHIP CAP.	0.001uF	50V	B	GRM188B11H102KA01D	K22174821		1-	A	A5
C 5757	CHIP CAP.	0.001uF	50V	B	GRM188B11H102KA01D	K22174821		1-	A	A5
C 5758	CHIP CAP.	0.001uF	50V	B	GRM188B11H102KA01D	K22174821		1-	A	A5
C 5759	CHIP CAP.	0.001uF	50V	B	GRM188B11H102KA01D	K22174821		1-	A	A4
C 5760	CHIP CAP.	0.001uF	50V	B	GRM188B11H102KA01D	K22174821		1-	A	A4
C 5761	CHIP CAP.	0.001uF	50V	B	GRM188B11H102KA01D	K22174821		1-	A	A4
C 5762	CHIP CAP.	0.001uF	50V	B	GRM188B11H102KA01D	K22174821		1-	A	A4
C 5763	CHIP CAP.	0.001uF	50V	B	GRM188B11H102KA01D	K22174821		1-	A	A5
C 5764	CHIP CAP.	0.001uF	50V	B	GRM188B11H102KA01D	K22174821		1-	A	A5
C 5765	CHIP CAP.	0.001uF	50V	B	GRM188B11H102KA01D	K22174821		1-	A	A4
C 5766	CHIP CAP.	0.001uF	50V	B	GRM188B11H102KA01D	K22174821		1-	A	A4
C 5767	CHIP CAP.	0.001uF	25V	CH	GRM1882C1E102JA01D	K22144204		1-	A	N7
C 5768	CHIP CAP.	0.001uF	25V	CH	GRM1882C1E102JA01D	K22144204		1-	A	O7
C 5769	CHIP CAP.	0.01uF	50V	B	GRM188B11H103KA01D	K22174823		1-	A	B4
C 5770	CHIP CAP.	0.047uF	25V	B	GRM188B11E473KA01D	K22144811		1-	A	A3
C 5780	CHIP CAP.	0.01uF	50V	B	GRM188B11H103KA01D	K22174823		1-	A	N8
C 5781	CHIP CAP.	0.001uF	50V	B	GRM188B11H102KA01D	K22174821		1-	A	N8
C 5782	CHIP CAP.	0.047uF	25V	B	GRM188B11E473KA01D	K22144811		1-	A	N8
C 5783	CHIP CAP.	0.001uF	50V	B	GRM188B11H102KA01D	K22174821		1-	A	N7
C 5784	CHIP CAP.	0.01uF	50V	B	GRM188B11H103KA01D	K22174823		1-	A	N7
C 5785	CHIP CAP.	0.1uF	16V	B	GRM188B11C104KA01D	K22124805		1-	A	N7
C 5786	CHIP CAP.	0.1uF	16V	B	GRM188B11C104KA01D	K22124805		1-	A	N8
C 5791	CHIP CAP.	0.1uF	16V	B	GRM188B11C104KA01D	K22124805		1-	A	B7
C 5792	CHIP CAP.	0.1uF	16V	B	GRM188B11C104KA01D	K22124805		1-	A	M9
C 5793	CHIP CAP.	0.01uF	50V	B	GRM188B11H103KA01D	K22174823		1-	A	B7

PA-B Unit

Parts List

REF	DESCRIPTION	VALUE	V/W	TOL.	MFR'S DESIG	VXSTD P/N	VERS.	LOT	SIDE	LAY ADR
C 5794	CHIP CAP.	0.01uF	50V	B	GRM188B11H103KA01D	K22174823		1-	A	M9
C 5795	CHIP CAP.	0.001uF	50V	B	GRM188B11H102KA01D	K22174821		1-	A	A7
C 5796	CHIP CAP.	0.001uF	50V	B	GRM188B11H102KA01D	K22174821		1-	A	M9
C 5797	AL.ELECTRO.CAP.	10uF	35V		EEE1VA100WR	K48160006		1-	A	N8
C 5798	AL.ELECTRO.CAP.	10uF	35V		EEE1VA100WR	K48160006		1-	A	I9
C 5799	CHIP CAP.	0.01uF	50V	B	GRM188B11H103KA01D	K22174823		1-	A	I9
C 5800	CHIP CAP.	0.001uF	50V	B	GRM188B11H102KA01D	K22174821		1-	A	N9
C 5801	CHIP CAP.	0.001uF	50V	B	GRM188B11H102KA01D	K22174821		1-	A	I9
C 5802	CHIP CAP.	0.01uF	50V	B	GRM188B11H103KA01D	K22174823		1-	A	N9
C 5803	CHIP CAP.	0.1uF	16V	B	GRM188B11C104KA01D	K22124805		1-	A	N9
C 5804	CHIP CAP.	0.01uF	50V	B	GRM188B11H103KA01D	K22174823		1-	A	N9
C 5805	CHIP CAP.	0.01uF	50V	B	GRM188B11H103KA01D	K22174823		1-	A	I9
C 5806	CHIP CAP.	0.001uF	50V	B	GRM188B11H102KA01D	K22174821		1-	A	I9
C 5807	CHIP CAP.	0.01uF	50V	B	GRM188B11H103KA01D	K22174823		1-	A	I9
C 5808	CHIP CAP.	0.01uF	50V	B	GRM188B11H103KA01D	K22174823		1-	A	N9
C 5809	AL.ELECTRO.CAP.	10uF	35V		EEE1VA100WR	K48160006		1-	A	I9
C 5811	CHIP TA.CAP.	1uF	16V		TEESVA1C105M8R	K78120009		1-	A	I9
C 5813	CHIP CAP.	0.01uF	50V	B	GRM188B11H103KA01D	K22174823		1-	A	O9
C 5814	CHIP CAP.	0.01uF	50V	B	GRM188B11H103KA01D	K22174823		1-	A	O9
C 5815	CHIP CAP.	0.1uF	16V	B	GRM188B11C104KA01D	K22124805		1-	A	M8
C 5816	CHIP CAP.	0.01uF	50V	B	GRM188B11H103KA01D	K22174823		1-	A	M8
C 5818	CHIP CAP.	0.1uF	25V	B	GRM21BB11E104KA01L	K22140811		1-	A	M8
C 5820	CHIP CAP.	0.001uF	100V	CH	GRM31M2C2A102JZ01L	K22201202		1-	A	J8
C 5821	CHIP CAP.	0.01uF	250V	X7R	GRM21BR72E103KW03L	K22240801		1-	A	J8
C 5822	CHIP CAP.	0.1uF	250V	X7R	GRM32DR72E104KW01L	K22245801		1-	A	K8
C 5823	CHIP CAP.	0.1uF	250V	X7R	GRM32DR72E104KW01L	K22245801		1-	A	M8
C 5824	CHIP CAP.	0.01uF	250V	X7R	GRM21BR72E103KW03L	K22240801		1-	A	M8
C 5825	CHIP CAP.	0.001uF	100V	CH	GRM31M2C2A102JZ01L	K22201202		1-	A	M8
C 5826	FILM CAP.	18pF	500V		UC232H0180J-T	K33279029		1-	A	I1
C 5827	AL.ELECTRO.CAP.	10uF	63V		RC2-63V100M	K40189012		1-	A	B3
D 5501	DIODE				BAS316	G2070716		1-	A	D5
D 5502	DIODE				BAS316	G2070716		1-	A	D5
D 5504	DIODE				RSX101VA-30TR	G2070984		1-	A	B6
D 5506	DIODE				10EDB10	G2090781		1-	A	E2
D 5507	DIODE				10EDB10	G2090781		1-	A	D4
D 5508	DIODE				RB051L-40TE25	G2070718		1-	A	N8
D 5509	DIODE				BAS316	G2070716		1-	A	N8
D 5510	DIODE				RSX101VA-30TR	G2070984		1-	A	I9
D 5511	DIODE				BAS316	G2070716		1-	A	N9
FB5502	FERRITE BEADS				BLM18PG330SN1D	L9190141		1-	A	M8
FB5503	FERRITE BEADS				BLM18PG330SN1D	L9190141		1-	A	N7
FB5504	FERRITE BEADS				BLM18PG330SN1D	L9190141		1-	A	O7
FB5505	FERRITE BEADS				BLM18PG330SN1D	L9190141		1-	A	C9
J 5501	CONNECTOR				TMP-S01X-C1	P1091254		1-	B	o2
J 5504	CONNECTOR				30FLT-SM2-TB(LF)(SN)(M)	P1091142		1-	A	A5
J 5517	CONNECTOR				CTP-106E	P1091397		1-	B	b1
J 5520	CONNECTOR				B3B-XH-A(LF)(SN)	P0091413		1-	B	a7
J 5530	CONNECTOR				SC25-08WS	P0090627		1-	B	b9
J 5531	CONNECTOR				IMSA-9202B-1-02-T	P0091174		1-	B	o4
L 5501	M.RFC	1uH			LAL03NA1ROM	L1190149		1-	A	A2
L 5502	RFC A1				43T0.16 4X9CB-20	L1020666A		1-	A	A3
L 5503	RFC WITH BEADS				FB-43-5111	L1020015		1-	A	B3
L 5505	RFC WITH BEADS				3A RI5.8X6.4-2	L1020728A		1-	A	F4
L 5506	RFC A1				43T0.16 4X9CB-20	L1020666A		1-	A	A7
L 5507	RFC WITH BEADS				3A RI5.8X6.4-2	L1020728A		1-	A	G4
L 5508	TOROIDAL COIL	3.91uH			3.91U T80-2	L0023075		1-	A	H7
L 5509	TOROIDAL COIL	1.21uH			1.21U T80-2	L0023074		1-	A	J3
L 5510	TOROIDAL COIL	0.85uH			0.85U T80-2	L0023069		1-	A	H5
L 5511	TOROIDAL COIL	0.42uH			0.42U T80-6	L0023065		1-	A	H5
L 5512	TOROIDAL COIL	0.39uH			0.39U T80-6	L0023064		1-	A	H7
L 5513	TOROIDAL COIL	0.25uH			0.25U T80-6	L0023062		1-	A	I4
L 5514	COIL A1				3.5T13.0D2.0UEW R	L0022725		1-	A	I2
L 5515	TOROIDAL COIL	5.16uH			5.16U T80-2	L0023077		1-	A	I6
L 5516	TOROIDAL COIL	1.88uH			1.88U T80-2	L0023073		1-	A	K3
L 5517	TOROIDAL COIL	1.31uH			1.31U T80-2	L0023070		1-	A	I6
L 5518	TOROIDAL COIL	0.66uH			0.66U T-80-2	L0021984		1-	A	J5
L 5519	TOROIDAL COIL	0.52uH			0.52U T80-6	L0023067		1-	A	J7
L 5520	TOROIDAL COIL	0.34uH			0.34U T80-6	L0023063		1-	A	J4
L 5521	COIL A1				3.5T13.0D2.0UEW R	L0022725		1-	A	J1
L 5522	TOROIDAL COIL	0.7uH			0.70U T80-2	L0023068		1-	A	K5
L 5523	TOROIDAL COIL	0.5uH			0.50U T80-6	L0023066		1-	A	K7
L 5524	TOROIDAL COIL	0.34uH			0.34U T80-6	L0023063		1-	A	K4
L 5525	COIL A1				2.5T14.0D2.0UEW R	L0022724		1-	A	K2

PA-B Unit

Parts List

REF	DESCRIPTION	VALUE	V/W	TOL.	MFR'S DESIG	VXSTD P/N	VERS.	LOT	SIDE	LAY ADR
L 5526	TOROIDAL COIL	5.04uH			5.04U T80-2	L0023076		1-	A	K6
L 5527	TOROIDAL COIL	1.99uH			1.99U T80-2	L0023072		1-	A	L3
L 5528	TOROIDAL COIL	1.39uH			1.39U T80-2	L0023071		1-	A	K6
L 5529	RFC WITH BEADS				3A R15.8X6.4-2	L1020728A		1-	A	E5
L 5530	RFC WITH BEADS				FB-43-5111	L1020015		1-	A	C4
P 5501	CONNECTOR				IMSA-9206H-T	P1090988		1-		
Q 5501	IC				M5223AFP 600C	G1092955		1-	A	A3
Q 5502	IC				M5223AFP 600C	G1092955		1-	A	C6
Q 5503	IC				M5223AFP 600C	G1092955		1-	A	C7
Q 5508	FET				RD06HHF1-01	G3090145		1-	A	A1
Q 5511	IC				M5223AFP 600C	G1092955		1-	A	D6
Q 5513	IC				TD62783AFNG(5.S.EL)	G1092700		1-	A	D9
Q 5514	FET				SD2918	G3090147		1-	A	B2
Q 5515	FET				VRF150	G3090156		1-	A	E2
Q 5516	FET				VRF150	G3090156		1-	A	E4
Q 5517	IC				M5218AFP-600C	G1091607		1-	A	E6
Q 5519	IC				PQ09TZ1U	G1092599		1-	A	B6
Q 5527	TRANSISTOR				DTD123YK T146	G3070157		1-	A	C7
Q 5528	TRANSISTOR				DTD123YK T146	G3070157		1-	A	C7
Q 5529	TRANSISTOR				DTD123YK T146	G3070157		1-	A	C7
Q 5530	TRANSISTOR				DTD123YK T146	G3070157		1-	A	D7
Q 5531	IC				PQ09RF21J00H	G1094351		1-	A	H9
Q 5532	TRANSISTOR				UMD5N TR	G3070343		1-	A	N9
Q 5533	TRANSISTOR				DTC123JE TL	G3070323		1-	A	O9
Q 5534	IC				LM20BIM7	G1094585		1-	A	E4
R 5505	CHIP RES.	0	1/16W	5%	RMC1/16 000JATP	J24185000		1-	A	A4
R 5511	CHIP RES.	3.9k	1/16W	5%	RMC1/16 392JATP	J24185392		1-	A	A4
R 5512	CHIP RES.	100k	1/16W	5%	RMC1/16 104JATP	J24185104		1-	A	A4
R 5513	CHIP RES.	0	1/16W	5%	RMC1/16 000JATP	J24185000		1-	A	A2
R 5514	CHIP RES.	100k	1/16W	5%	RMC1/16 104JATP	J24185104		1-	A	A4
R 5518	CHIP RES.	10k	1/16W	5%	RMC1/16 103JATP	J24185103		1-	A	A4
R 5519	CHIP RES.	100k	1/16W	5%	RMC1/16 104JATP	J24185104		1-	A	A4
R 5524	CHIP RES.	100k	1/16W	5%	RMC1/16 104JATP	J24185104		1-	A	A3
R 5527	CHIP RES.	10k	1/16W	5%	RMC1/16 103JATP	J24185103		1-	A	A3
R 5528	CHIP RES.	100	1/4W	5%	RMC1/4 101JATP	J24245101		1-	A	A2
R 5529	CHIP RES.	1k	1/16W	5%	RMC1/16 102JATP	J24185102		1-	A	A3
R 5530	CHIP RES.	2.2k	1/10W	5%	RMC1/10T 222J	J24205222		1-	A	A2
R 5532	CHIP RES.	330	1/4W	5%	RMC1/4 331JATP	J24245331		1-	A	A2
R 5537	CHIP RES.	0	1/16W	5%	RMC1/16 000JATP	J24185000		1-	A	D7
R 5538	CHIP RES.	0	1/16W	5%	RMC1/16 000JATP	J24185000		1-	A	D7
R 5541	CHIP RES.	100k	1/16W	5%	RMC1/16 104JATP	J24185104		1-	A	D7
R 5542	CHIP RES.	100k	1/16W	5%	RMC1/16 104JATP	J24185104		1-	A	D6
R 5543	CHIP RES.	470	1/4W	5%	RMC1/4 471JATP	J24245471		1-	A	B2
R 5546	CHIP RES.	100k	1/16W	5%	RMC1/16 104JATP	J24185104		1-	A	D7
R 5547	CHIP RES.	100k	1/16W	5%	RMC1/16 104JATP	J24185104		1-	A	D6
R 5548	CHIP RES.	100k	1/16W	5%	RMC1/16 104JATP	J24185104		1-	A	D6
R 5549	CHIP RES.	100k	1/16W	5%	RMC1/16 104JATP	J24185104		1-	A	D6
R 5550	CHIP RES.	10k	1/16W	5%	RMC1/16 103JATP	J24185103		1-	A	D7
R 5551	CHIP RES.	10k	1/16W	5%	RMC1/16 103JATP	J24185103		1-	A	D6
R 5552	CHIP RES.	3.3k	1/10W	5%	RMC1/10T 332J	J24205332		1-	A	B2
R 5553	CHIP RES.	100k	1/16W	5%	RMC1/16 104JATP	J24185104		1-	A	D6
R 5554	CHIP RES.	100k	1/16W	5%	RMC1/16 104JATP	J24185104		1-	A	D6
R 5555	CHIP RES.	470	1W	5%	RMC1 471JTE	J24305471		1-	A	C1
R 5556	CHIP RES.	1k	1/16W	5%	RMC1/16 102JATP	J24185102		1-	A	B3
R 5557	CHIP RES.	10k	1/16W	5%	RMC1/16 103JATP	J24185103		1-	A	D6
R 5558	CHIP RES.	10k	1/16W	5%	RMC1/16 103JATP	J24185103		1-	A	D6
R 5559	CHIP RES.	0	1/16W	5%	RMC1/16 000JATP	J24185000		1-	A	B3
R 5560	CHIP RES.	2.2k	1/10W	5%	RMC1/10T 222J	J24205222		1-	A	D6
R 5561	CHIP RES.	10k	1/16W	5%	RMC1/16 103JATP	J24185103		1-	A	D1
R 5562	METAL FILM RES.	3.3	2W	5%	ERG-2SJ3R3P 3.3	J22339003		1-	A	C2
R 5563	METAL FILM RES.	3.3	2W	5%	ERG-2SJ3R3P 3.3	J22339003		1-	A	C3
R 5564	CHIP RES.	10k	1/16W	5%	RMC1/16 103JATP	J24185103		1-	A	D4
R 5565	CHIP RES.	1k	1/16W	5%	RMC1/16 102JATP	J24185102		1-	A	B6
R 5566	CHIP RES.	22k	1/16W	5%	RMC1/16 223JATP	J24185223		1-	A	D4
R 5567	CHIP RES.	0	1/16W	5%	RMC1/16 000JATP	J24185000		1-	A	B4
R 5568	CHIP RES.	22k	1/16W	5%	RMC1/16 223JATP	J24185223		1-	A	D1
R 5569	CHIP RES.	2.2k	1/10W	5%	RMC1/10T 222J	J24205222		1-	A	D6
R 5570	METAL FILM RES.	120	2W	5%	ERG-2SJ121P 120	J22339015		1-	A	D1
R 5571	METAL FILM RES.	120	2W	5%	ERG-2SJ121P 120	J22339015		1-	A	D3
R 5573	METAL FILM RES.	22	2W	5%	ERG-2SJ220P 22	J22339014		1-	A	D1
R 5574	METAL FILM RES.	22	2W	5%	ERG-2SJ220P 22	J22339014		1-	A	D4
R 5578	CHIP RES.	1k	1/16W	0.5%	RR0510P-102-D	J24189119		1-	A	B4
R 5579	CHIP RES.	18k	1/16W	0.5%	RR0510R-183-D	J24189149		1-	A	B4

PA-B Unit

Parts List

REF	DESCRIPTION	VALUE	V/W	TOL.	MFR'S DESIG	VXSTD P/N	VERS.	LOT	SIDE	LAY ADR
R 5580	CEMENT RES.	0.05	5W	10%	ERF-5AKR05	J30379001		1-	A	E6
R 5582	CHIP RES.	22k	1/16W	0.1%	RN731JTDD2202B25	J24189410		1-	A	E5
R 5583	CHIP RES.	22k	1/16W	0.1%	RN731JTDD2202B25	J24189410		1-	A	E5
R 5584	CHIP RES.	2.7k	1/16W	0.1%	RN731JTDD2701B25	J24189408		1-	A	E5
R 5585	CHIP RES.	2.7k	1/16W	0.1%	RN731JTDD2701B25	J24189408		1-	A	E5
R 5586	CHIP RES.	5.6k	1/16W	0.1%	RN731JTDD5601B25	J24189409		1-	A	E5
R 5587	CHIP RES.	5.6k	1/16W	0.1%	RN731JTDD5601B25	J24189409		1-	A	E5
R 5588	CHIP RES.	220k	1/16W	1%	RMC1/16 224FTP	J24183224		1-	A	E5
R 5589	CHIP RES.	220k	1/16W	1%	RMC1/16 224FTP	J24183224		1-	A	E5
R 5591	CHIP RES.	0	1/16W	5%	RMC1/16 000JATP	J24185000		1-	A	E6
R 5592	CHIP RES.	470	1/16W	5%	RMC1/16 471JATP	J24185471		1-	A	E6
R 5596	CHIP RES.	10k	1/16W	5%	RMC1/16 103JATP	J24185103		1-	A	C6
R 5597	CHIP RES.	10k	1/16W	5%	RMC1/16 103JATP	J24185103		1-	A	C6
R 5598	CHIP RES.	10k	1/16W	5%	RMC1/16 103JATP	J24185103		1-	A	C6
R 5599	CHIP RES.	3.9k	1/16W	5%	RMC1/16 392JATP	J24185392		1-	A	B6
R 5600	CHIP RES.	10k	1/16W	5%	RMC1/16 103JATP	J24185103		1-	A	C6
R 5601	CHIP RES.	10k	1/16W	5%	RMC1/16 103JATP	J24185103		1-	A	C6
R 5602	CHIP RES.	10k	1/16W	5%	RMC1/16 103JATP	J24185103		1-	A	C6
R 5603	CHIP RES.	4.7k	1/16W	5%	RMC1/16 472JATP	J24185472		1-	A	C6
R 5604	CHIP RES.	10k	1/16W	5%	RMC1/16 103JATP	J24185103		1-	A	C7
R 5605	CHIP RES.	10k	1/16W	5%	RMC1/16 103JATP	J24185103		1-	A	C6
R 5606	CHIP RES.	10k	1/16W	5%	RMC1/16 103JATP	J24185103		1-	A	C7
R 5607	CHIP RES.	5.6k	1/16W	5%	RMC1/16 562JATP	J24185562		1-	A	B7
R 5608	CHIP RES.	10k	1/16W	5%	RMC1/16 103JATP	J24185103		1-	A	C7
R 5609	CHIP RES.	10k	1/16W	5%	RMC1/16 103JATP	J24185103		1-	A	C7
R 5610	CHIP RES.	10k	1/16W	5%	RMC1/16 103JATP	J24185103		1-	A	C7
R 5611	CHIP RES.	6.8k	1/16W	5%	RMC1/16 682JATP	J24185682		1-	A	C7
R 5612	CHIP RES.	33	1W	5%	RMC1 330JTE	J24305330		1-	A	C7
R 5613	CHIP RES.	33	1W	5%	RMC1 330JTE	J24305330		1-	A	D7
R 5614	CHIP RES.	22	1W	5%	RMC1 220JTE	J24305220		1-	A	D7
R 5618	CHIP RES.	270k	1/16W	5%	RMC1/16 274JATP	J24185274		1-	A	C6
R 5619	CHIP RES.	330k	1/16W	5%	RMC1/16 334JATP	J24185334		1-	A	C6
R 5620	CHIP RES.	330k	1/16W	5%	RMC1/16 334JATP	J24185334		1-	A	C6
R 5621	CHIP RES.	330k	1/16W	5%	RMC1/16 334JATP	J24185334		1-	A	C7
R 5622	CHIP RES.	220	1/16W	5%	RMC1/16 221JATP	J24185221		1-	A	D7
R 5623	CHIP RES.	0	1/16W	5%	RMC1/16 000JATP	J24185000		1-	A	D7
R 5626	CHIP RES.	3.9k	1/16W	5%	RMC1/16 392JATP	J24185392		1-	A	A3
R 5627	CHIP RES.	10k	1/16W	5%	RMC1/16 103JATP	J24185103		1-	A	A3
R 5628	CHIP RES.	100k	1/16W	5%	RMC1/16 104JATP	J24185104		1-	A	A4
R 5629	CHIP RES.	100k	1/16W	5%	RMC1/16 104JATP	J24185104		1-	A	A4
R 5630	CHIP RES.	0	1/16W	5%	RMC1/16 000JATP	J24185000		1-	A	A4
R 5631	CHIP RES.	100k	1/16W	5%	RMC1/16 104JATP	J24185104		1-	A	A4
R 5632	CHIP RES.	100k	1/16W	5%	RMC1/16 104JATP	J24185104		1-	A	A3
R 5633	CHIP RES.	10k	1/16W	5%	RMC1/16 103JATP	J24185103		1-	A	A3
R 5634	CHIP RES.	0	1/16W	5%	RMC1/16 000JATP	J24185000		1-	A	A3
R 5635	CHIP RES.	0	1/16W	5%	RMC1/16 000JATP	J24185000		1-	A	I9
R 5637	CHIP RES.	0	1/10W	5%	RMC1/10T 000J	J24205000		1-	A	C3
R 5639	CARBON FILM RES.	330	1/2W	5%	RD12TJ331 330	J01275331		1-		
RL5501	RELAY		DC12V		AJQ1341 DC12V	M1190172		1-	A	F6
RL5502	RELAY		DC12V		AJQ1341 DC12V	M1190172		1-	A	I3
RL5503	RELAY		DC12V		AJQ1341 DC12V	M1190172		1-	A	F6
RL5504	RELAY		DC12V		AJQ1341 DC12V	M1190172		1-	A	G5
RL5505	RELAY		DC12V		AJQ1341 DC12V	M1190172		1-	A	F7
RL5506	RELAY		DC12V		AJQ1341 DC12V	M1190172		1-	A	G4
RL5507	RELAY		DC12V		JS-12-K DC12V	M1190154		1-	A	I3
RL5508	RELAY		DC12V		AJQ1341 DC12V	M1190172		1-	A	M7
RL5509	RELAY		DC12V		AJQ1341 DC12V	M1190172		1-	A	M4
RL5510	RELAY		DC12V		AJQ1341 DC12V	M1190172		1-	A	M6
RL5511	RELAY		DC12V		AJQ1341 DC12V	M1190172		1-	A	M5
RL5512	RELAY		DC12V		AJQ1341 DC12V	M1190172		1-	A	M7
RL5513	RELAY		DC12V		AJQ1341 DC12V	M1190172		1-	A	M4
RL5514	RELAY		DC12V		JS-12-K DC12V	M1190154		1-	A	L1
RL5515	RELAY		DC12V		ACP331 DC12V	M1190175		1-	A	N8
T 5501	COIL 10WIDE				1-1 3A6 RIB4X7X5	L0022924		1-	A	B2
T 5502	COIL PWR-WIDE				3A5 RIB10X20X10	L0022773		1-	A	C3
T 5503	COIL PWR-WIDE				D12A TR16	L0022068		1-	A	D3
T 5504	COIL PWR-WIDE				D12A RIB21	L0022883		1-	A	G2
T 5505	TOROIDAL COIL				D12A RI16X8X8(H007)	L0022745		1-	A	N7
T 5506	TOROIDAL COIL				D12A RI16X8X8(H007)	L0022745		1-	A	L9
TP5516	TERMINAL				TP-G MK1095	Q5000036		1-	A	E1

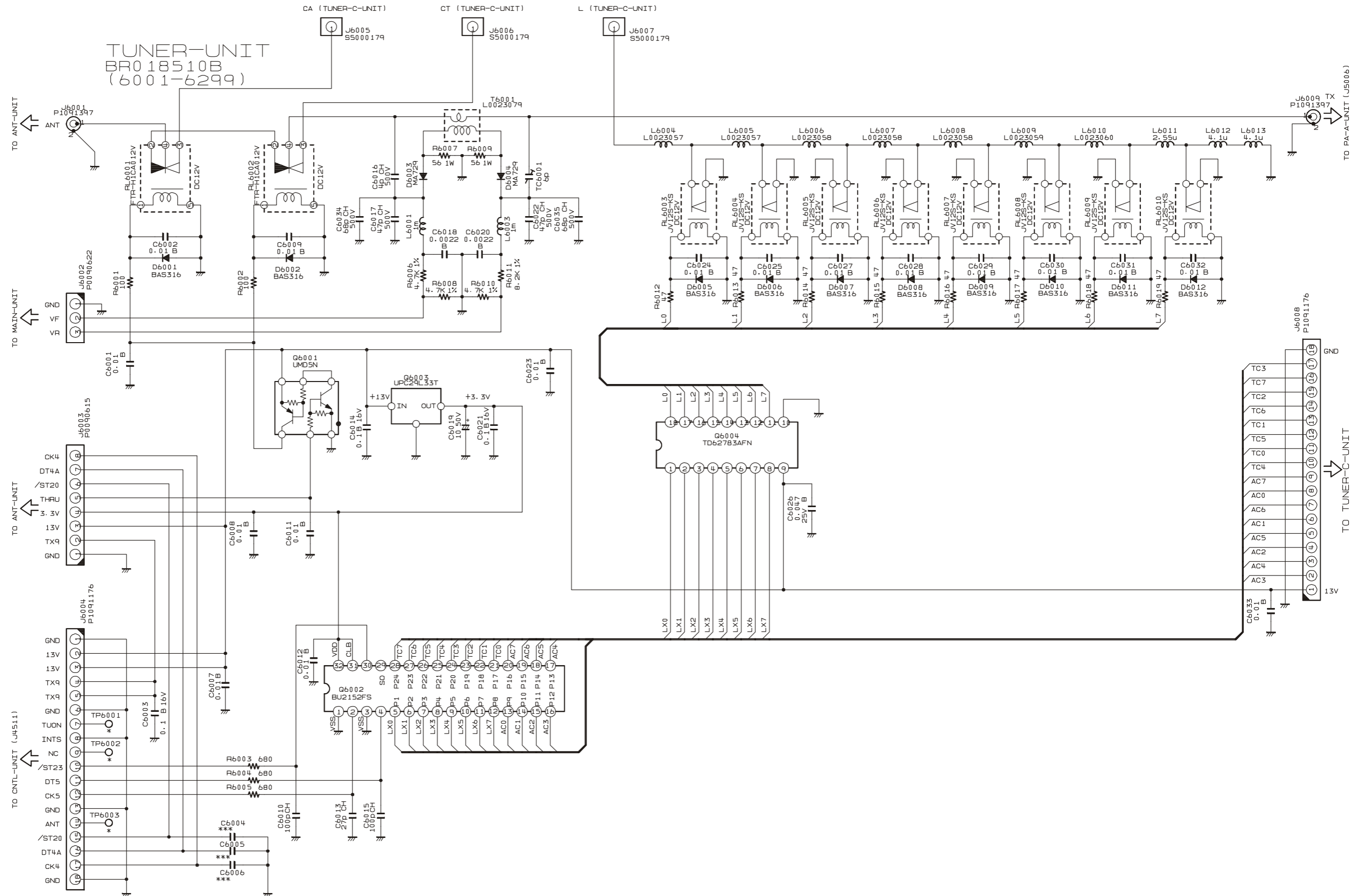

TUNER Unit (Lot. 1 ~ 20)

Note

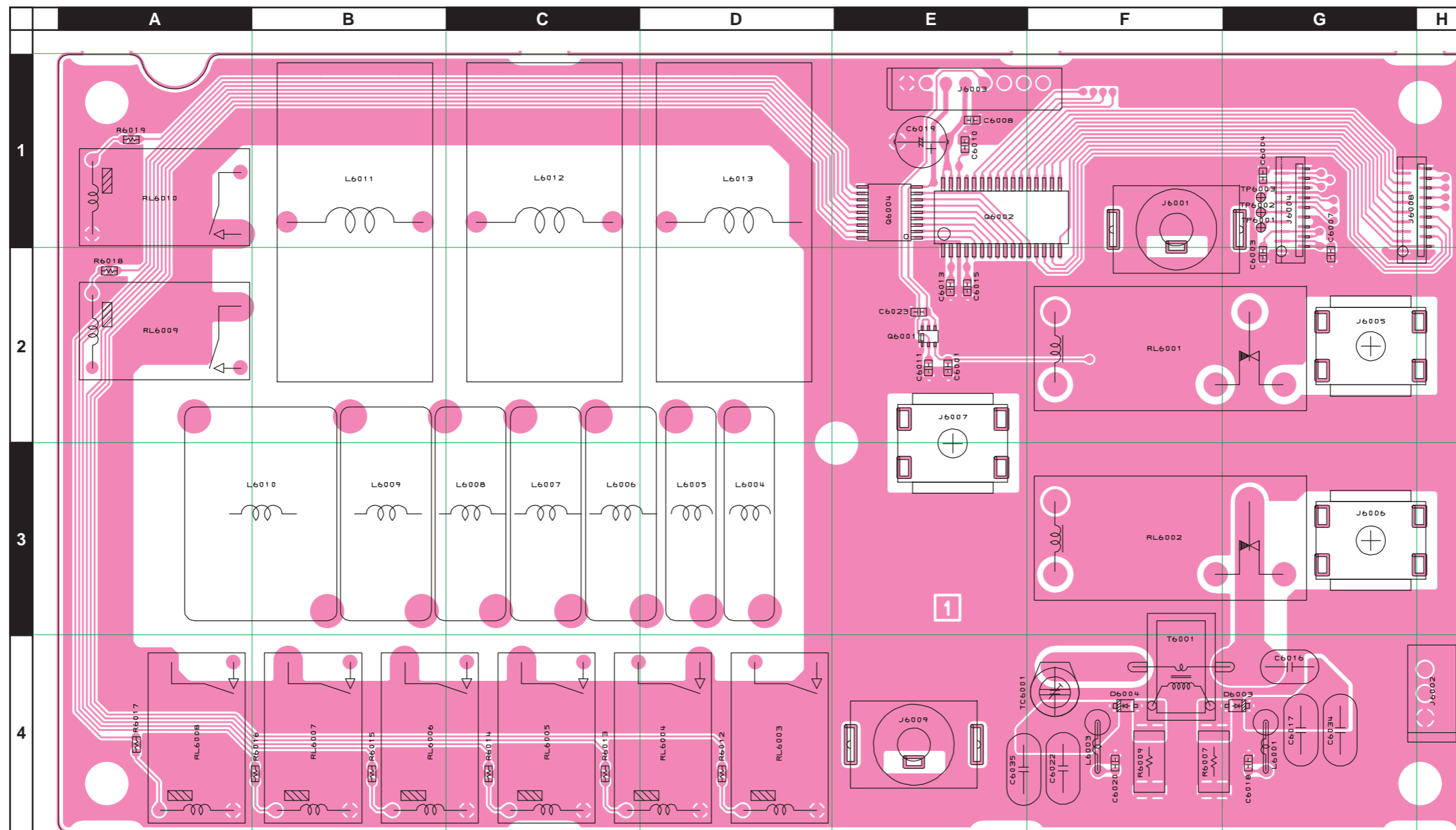

TUNER Unit (Lot. 1 ~ 20)

Parts Layout (Side B)

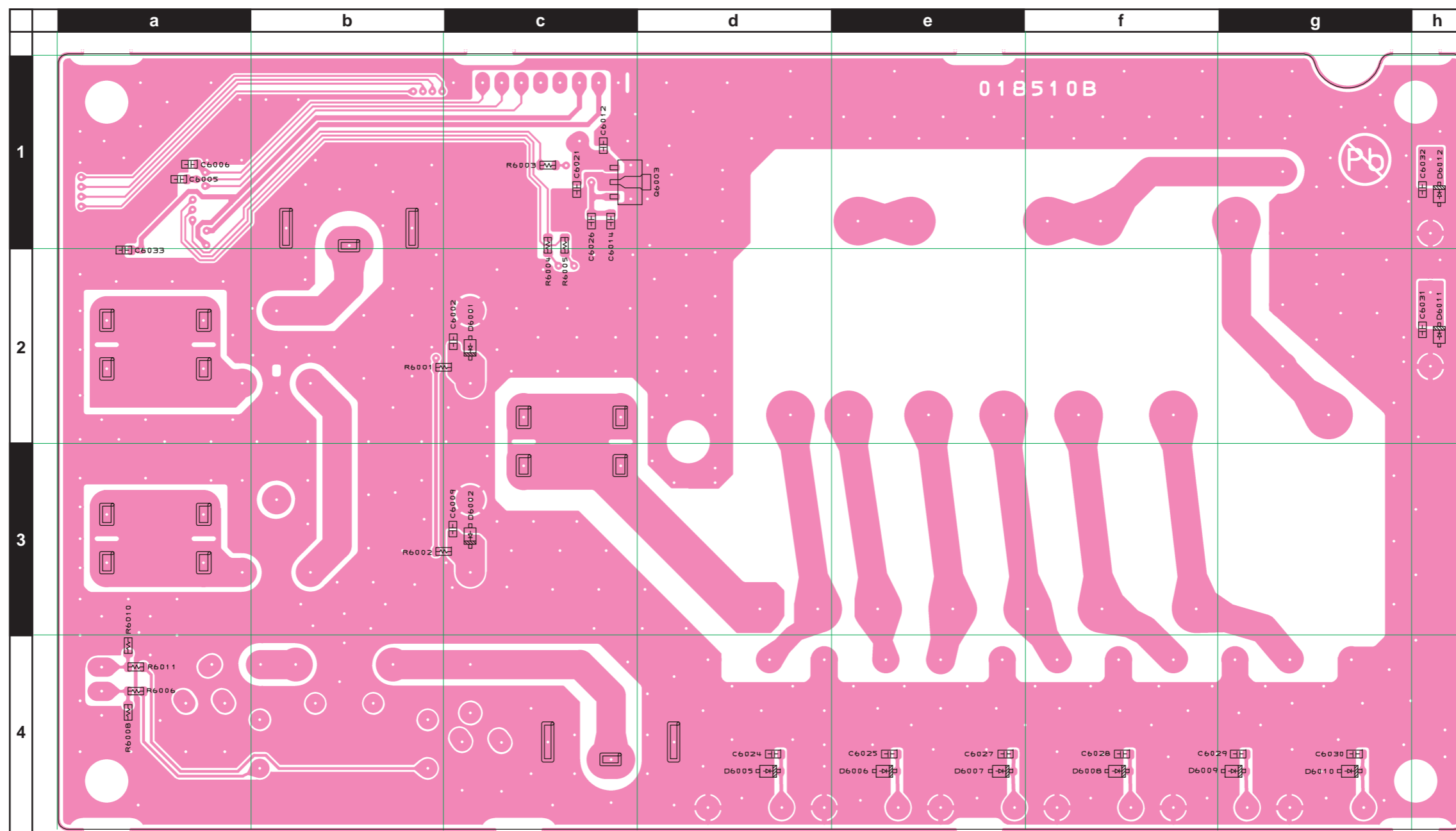

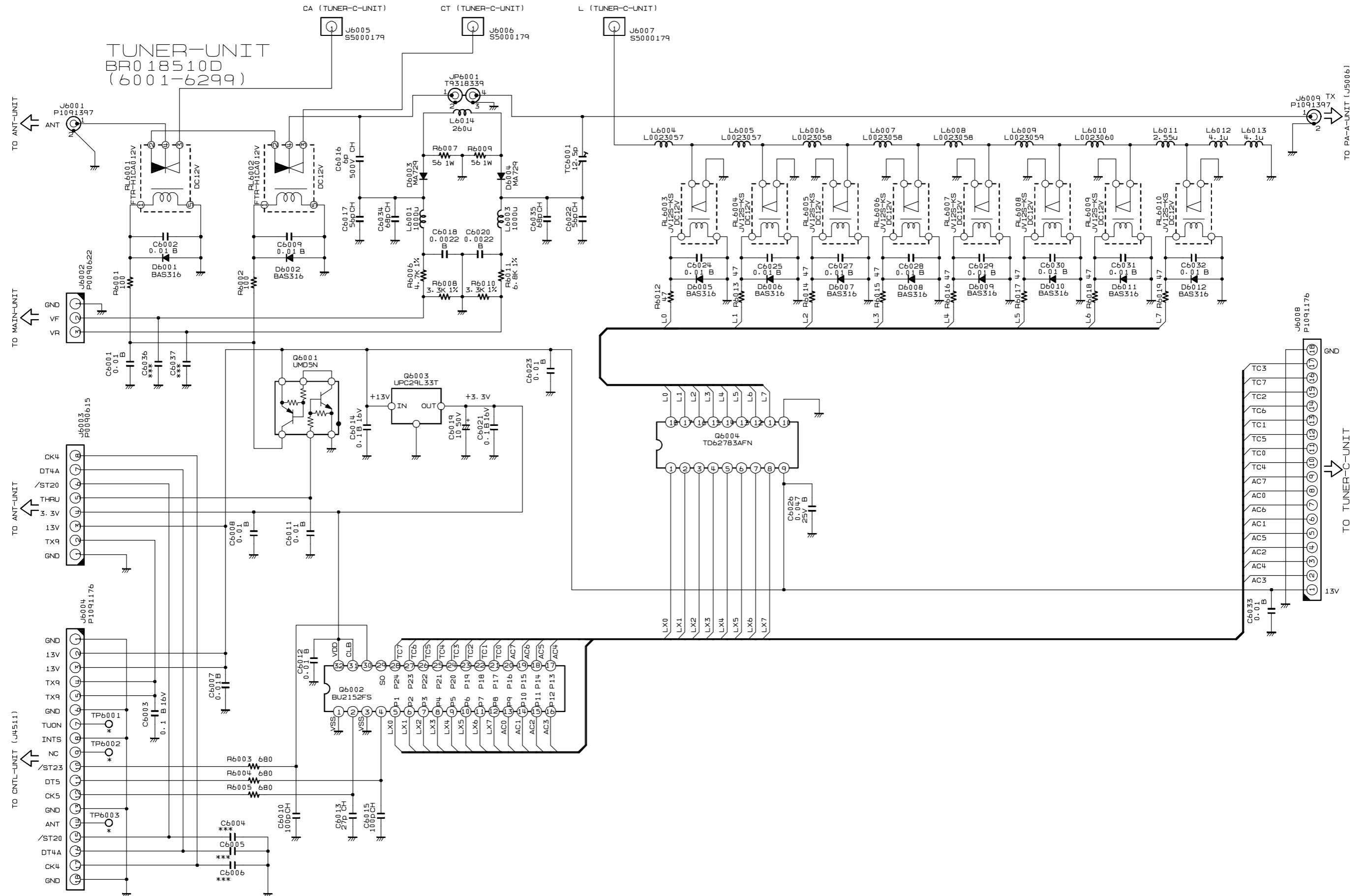

TUNER Unit (Lot. 21 ~)

Note

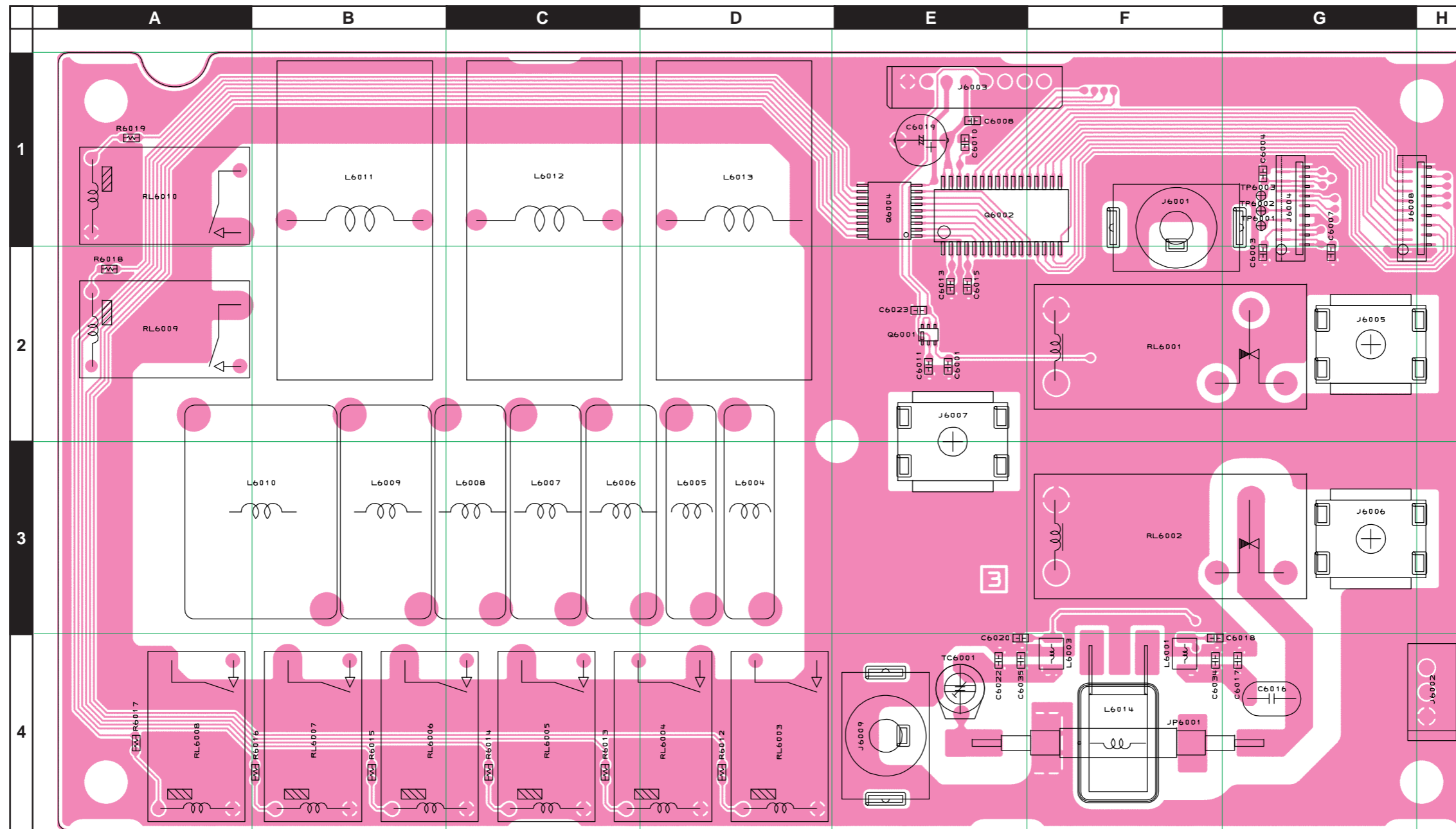

TUNER Unit (Lot. 21 ~)

Parts Layout (Side B)

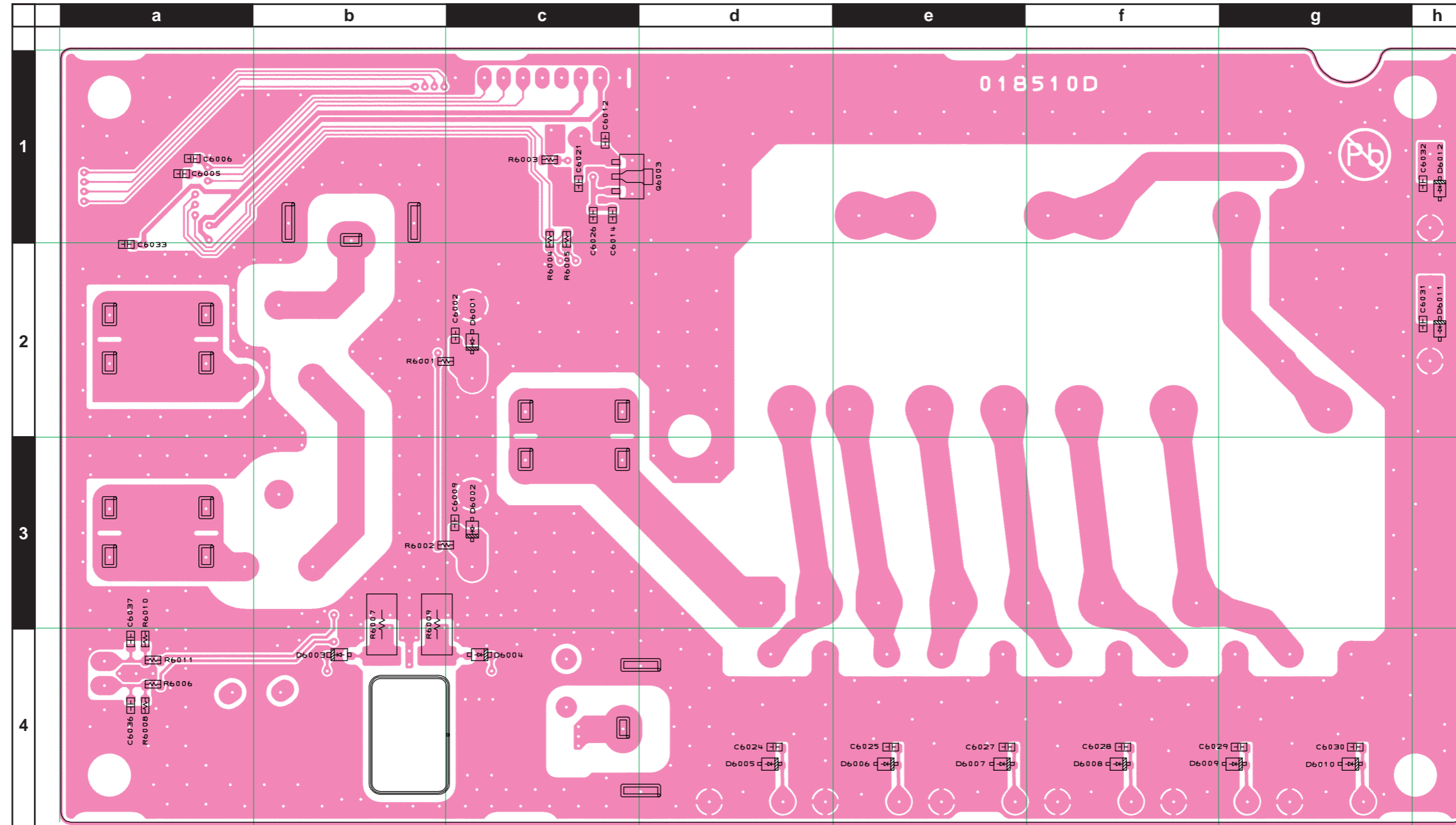

TUNER Unit

Parts List

REF	DESCRIPTION	VALUE	V/W	TOL.	MFR'S DESIG	VXSTD P/N	VERS.	LOT	SIDE	LAY ADR
PCB with Components						CS2083501				
	Printed Circuit Board					FR018510B				
	Printed Circuit Board					FR018510D		21-		
C 6001	CHIP CAP.	0.01uF	50V	B	GRM188B11H103KA01D	K22174823		1-	A	E7
C 6002	CHIP CAP.	0.01uF	50V	B	GRM188B11H103KA01D	K22174823		1-	B	f6
C 6003	CHIP CAP.	0.1uF	16V	B	GRM188B11C104KA01D	K22124805		1-	A	G6
C 6007	CHIP CAP.	0.01uF	50V	B	GRM188B11H103KA01D	K22174823		1-	A	G6
C 6008	CHIP CAP.	0.01uF	50V	B	GRM188B11H103KA01D	K22174823		1-	A	E5
C 6009	CHIP CAP.	0.01uF	50V	B	GRM188B11H103KA01D	K22174823		1-	B	f7
C 6010	CHIP CAP.	100pF	50V	CH	GRM1882C1H101JA01D	K22174235		1-	A	E5
C 6011	CHIP CAP.	0.01uF	50V	B	GRM188B11H103KA01D	K22174823		1-	A	E7
C 6012	CHIP CAP.	0.01uF	50V	B	GRM188B11H103KA01D	K22174823		1-	B	g5
C 6013	CHIP CAP.	27pF	50V	CH	GRM1882C1H270JA01D	K22174221		1-	A	E6
C 6014	CHIP CAP.	0.1uF	16V	B	GRM188B11C104KA01D	K22124805		1-	B	g6
C 6015	CHIP CAP.	100pF	50V	CH	GRM1882C1H101JA01D	K22174235		1-	A	E6
C 6016	CERAMIC CAP.	4pF	500V	CH	RT-HM60SKCH040C	K26270145		1-	A	G8
C 6016	CERAMIC CAP.	6pF	500V	CH	RT-HM60SKCH060D	K26270147		21-	A	G8
C 6017	CERAMIC CAP.	47pF	500V	CH	RT-HM74SKCH470J	K26270159		1-	A	G8
C 6017	CHIP CAP.	56pF	50V	CH	GRM1882C1H560JA01D	K22174229		21-	A	G8
C 6018	CHIP CAP.	0.0022uF	50V	B	GRM188B11H222KA01D	K22174822		1-	A	F8
C 6019	AL.ELECTRO.CAP.	10uF	50V		RE2-50V100ME3#-T2	K46170021		1-	A	E5
C 6020	CHIP CAP.	0.0022uF	50V	B	GRM188B11H222KA01D	K22174822		1-	A	E8
C 6021	CHIP CAP.	0.1uF	16V	B	GRM188B11C104KA01D	K22124805		1-	B	f6
C 6022	CERAMIC CAP.	47pF	500V	CH	RT-HM74SKCH470J	K26270159		1-	A	E8
C 6022	CHIP CAP.	56pF	50V	CH	GRM1882C1H560JA01D	K22174229		21-	A	E8
C 6023	CHIP CAP.	0.01uF	50V	B	GRM188B11H103KA01D	K22174823		1-	A	E6
C 6024	CHIP CAP.	0.01uF	50V	B	GRM188B11H103KA01D	K22174823		1-	B	g9
C 6025	CHIP CAP.	0.01uF	50V	B	GRM188B11H103KA01D	K22174823		1-	B	h9
C 6026	CHIP CAP.	0.047uF	25V	B	GRM188B11E473KA01D	K22144811		1-	B	g6
C 6027	CHIP CAP.	0.01uF	50V	B	GRM188B11H103KA01D	K22174823		1-	B	i9
C 6028	CHIP CAP.	0.01uF	50V	B	GRM188B11H103KA01D	K22174823		1-	B	i9
C 6029	CHIP CAP.	0.01uF	50V	B	GRM188B11H103KA01D	K22174823		1-	B	j9
C 6030	CHIP CAP.	0.01uF	50V	B	GRM188B11H103KA01D	K22174823		1-	B	j9
C 6031	CHIP CAP.	0.01uF	50V	B	GRM188B11H103KA01D	K22174823		1-	B	k6
C 6032	CHIP CAP.	0.01uF	50V	B	GRM188B11H103KA01D	K22174823		1-	B	k6
C 6033	CHIP CAP.	0.01uF	50V	B	GRM188B11H103KA01D	K22174823		1-	B	d6
C 6034	CERAMIC CAP.	68pF	500V	CH	RT-HM95SKCH680J	K26270161		1-	A	F8
C 6034	CHIP CAP.	68pF	50V	CH	GRM1882C1H680JA01D	K22174231		21-	A	F8
C 6035	CERAMIC CAP.	68pF	500V	CH	RT-HM95SKCH680J	K26270161		1-	A	E8
C 6035	CHIP CAP.	68pF	50V	CH	GRM1882C1H680JA01D	K22174231		21-	A	E8
D 6001	DIODE				BAS316	G2070716		1-	B	f7
D 6002	DIODE				BAS316	G2070716		1-	B	f7
D 6003	DIODE				MA729-(TX)	G2070320		1-	B	e8
D 6004	DIODE				MA729-(TX)	G2070320		1-	B	f8
D 6005	DIODE				BAS316	G2070716		1-	B	g9
D 6006	DIODE				BAS316	G2070716		1-	B	h9
D 6007	DIODE				BAS316	G2070716		1-	B	i9
D 6008	DIODE				BAS316	G2070716		1-	B	i9
D 6009	DIODE				BAS316	G2070716		1-	B	j9
D 6010	DIODE				BAS316	G2070716		1-	B	j9
D 6011	DIODE				BAS316	G2070716		1-	B	k6
D 6012	DIODE				BAS316	G2070716		1-	B	k6
J 6001	CONNECTOR				CTP-106E	P1091397		1-	A	F6
J 6002	CONNECTOR				SC25-03WS	P0090622		1-	A	H8
J 6003	CONNECTOR				SB20-08WS	P0090615		1-	A	E5
J 6004	CONNECTOR				18FLT-SM2-TB(LF)(SN)(M)	P1091176		1-	A	G6
J 6005	TERMINAL				Y106	S5000179		1-	A	G7
J 6006	TERMINAL				Y106	S5000179		1-	A	G8
J 6007	TERMINAL				Y106	S5000179		1-	A	E7
J 6008	CONNECTOR				18FLT-SM2-TB(LF)(SN)(M)	P1091176		1-	A	G6
J 6009	CONNECTOR				CTP-106E	P1091397		1-	A	E9
JP6001	WIRE ASSY				BLK 30 */*	T9318339		21-	A	F9
L 6001	M.RFC	1mH			LAL03NA102K	L1190189		1-	A	F8
L 6001	M.RFC	1000uH			LLM3225-102J	L1691157		21-	A	F8
L 6003	M.RFC	1mH			LAL03NA102K	L1190189		1-	A	F8
L 6003	M.RFC	1000uH			LLM3225-102J	L1691157		21-	A	F8
L 6004	COIL A1				1.5T18D2.0PEW-R	L0023057		1-	A	D7
L 6005	COIL A1				1.5T18D2.0PEW-R	L0023057		1-	A	D7
L 6006	COIL A1				2.5T18D2.0PEW-R	L0023058		1-	A	C7
L 6007	COIL A1				2.5T18D2.0PEW-R	L0023058		1-	A	C7
L 6008	COIL A1				2.5T18D2.0PEW-R	L0023058		1-	A	B7
L 6009	COIL A1				3.5T18D2.0PEW-R	L0023059		1-	A	B7
L 6010	COIL A1				6.5T18D2.0PEW-R	L0023060		1-	A	A7

TUNER Unit

Parts List

REF	DESCRIPTION	VALUE	V/W	TOL.	MFR'S DESIG	VXSTD P/N	VERS.	LOT	SIDE	LAY ADR
L 6011	TOROIDAL COIL	2.55uH			2.55U T106-2	L0022680		1-	A	B6
L 6012	TOROIDAL COIL	4.1uH			4.10U T106-2	L0023061		1-	A	C6
L 6013	TOROIDAL COIL	4.1uH			4.10U T106-2	L0023061		1-	A	D6
L 6014	TOROIDAL COIL	260uH			260U 3A R19.3-4.8-5	L0022767		21-	A	F9
Q 6001	TRANSISTOR				UMD5N TR	G3070343		1-	A	E6
Q 6002	IC				BU2152FS(TAPE)	G1093942		1-	A	E6
Q 6003	IC				UPC29L33T-T1	G1093465		1-	B	g6
Q 6004	IC				TD62783AFNG(5.S.EL)	G1092700		1-	A	E6
R 6001	CHIP RES.	100	1/16W	5%	RMC1/16 101JATP	J24185101		1-	B	f7
R 6002	CHIP RES.	100	1/16W	5%	RMC1/16 101JATP	J24185101		1-	B	f8
R 6003	CHIP RES.	680	1/16W	5%	RMC1/16 681JATP	J24185681		1-	B	f6
R 6004	CHIP RES.	680	1/16W	5%	RMC1/16 681JATP	J24185681		1-	B	f6
R 6005	CHIP RES.	680	1/16W	5%	RMC1/16 681JATP	J24185681		1-	B	f6
R 6006	CHIP RES.	4.7k	1/16W	1%	RMC1/16 472FTP	J24183472		1-	B	d8
R 6007	CHIP RES.	56	1W	5%	RMC1 560JTE	J24305560		1-	B	e8
R 6008	CHIP RES.	4.7k	1/16W	1%	RMC1/16 472FTP	J24183472		1-	B	d8
R 6008	CHIP RES.	3.3k	1/16W	1%	RMC1/16 332FTP	J24183332		21-	B	d8
R 6009	CHIP RES.	56	1W	5%	RMC1 560JTE	J24305560		1-	B	f8
R 6010	CHIP RES.	4.7k	1/16W	1%	RMC1/16 472FTP	J24183472		1-	B	d8
R 6010	CHIP RES.	3.3k	1/16W	1%	RMC1/16 332FTP	J24183332		21-	B	d8
R 6011	CHIP RES.	8.2k	1/16W	1%	RMC1/16 822FTP	J24183822		1-	B	d8
R 6011	CHIP RES.	6.8k	1/16W	1%	RMC1/16 682FTP	J24183682		21-	B	d8
R 6012	CHIP RES.	47	1/16W	5%	RMC1/16 470JATP	J24185470		1-	A	D9
R 6013	CHIP RES.	47	1/16W	5%	RMC1/16 470JATP	J24185470		1-	A	C9
R 6014	CHIP RES.	47	1/16W	5%	RMC1/16 470JATP	J24185470		1-	A	C9
R 6015	CHIP RES.	47	1/16W	5%	RMC1/16 470JATP	J24185470		1-	A	B9
R 6016	CHIP RES.	47	1/16W	5%	RMC1/16 470JATP	J24185470		1-	A	B9
R 6017	CHIP RES.	47	1/16W	5%	RMC1/16 470JATP	J24185470		1-	A	A9
R 6018	CHIP RES.	47	1/16W	5%	RMC1/16 470JATP	J24185470		1-	A	A6
R 6019	CHIP RES.	47	1/16W	5%	RMC1/16 470JATP	J24185470		1-	A	A5
RL6001	RELAY		DC12V		FTR-H1CA012V DC12V	M1190148		1-	A	G6
RL6002	RELAY		DC12V		FTR-H1CA012V DC12V	M1190148		1-	A	G7
RL6003	RELAY		DC12V		JV12S-KS DC12V	M1190205		1-	A	D9
RL6004	RELAY		DC12V		JV12S-KS DC12V	M1190205		1-	A	D9
RL6005	RELAY		DC12V		JV12S-KS DC12V	M1190205		1-	A	C9
RL6006	RELAY		DC12V		JV12S-KS DC12V	M1190205		1-	A	C9
RL6007	RELAY		DC12V		JV12S-KS DC12V	M1190205		1-	A	B9
RL6008	RELAY		DC12V		JV12S-KS DC12V	M1190205		1-	A	A9
RL6009	RELAY		DC12V		JV12S-KS DC12V	M1190205		1-	A	A7
RL6010	RELAY		DC12V		JV12S-KS DC12V	M1190205		1-	A	A6
T 6001	COIL WIDE-TRANS.				#223333A	L0023079		1-20		
TC6001	TRIMMER CAP.	6pF			CV05A0601	K91000284		1-	A	E8
TC6001	TRIMMER CAP.	12.5pF			CV05C1201	K91000286		21-	A	E8

TUNER-C-UNIT
BR020570B (6301-6499)

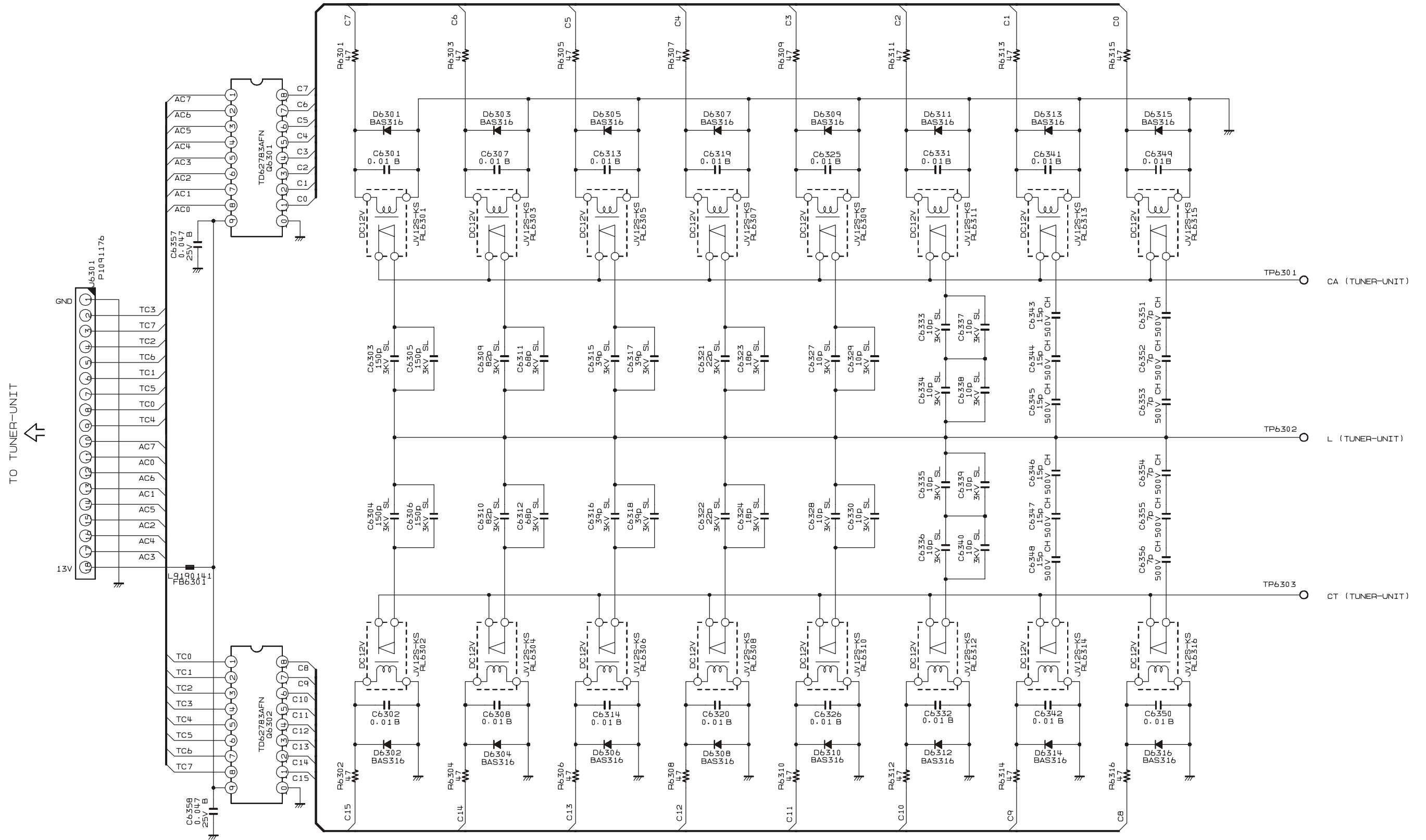

TUNER-C Unit

Note

TUNER-C Unit

Parts Layout (Side A)

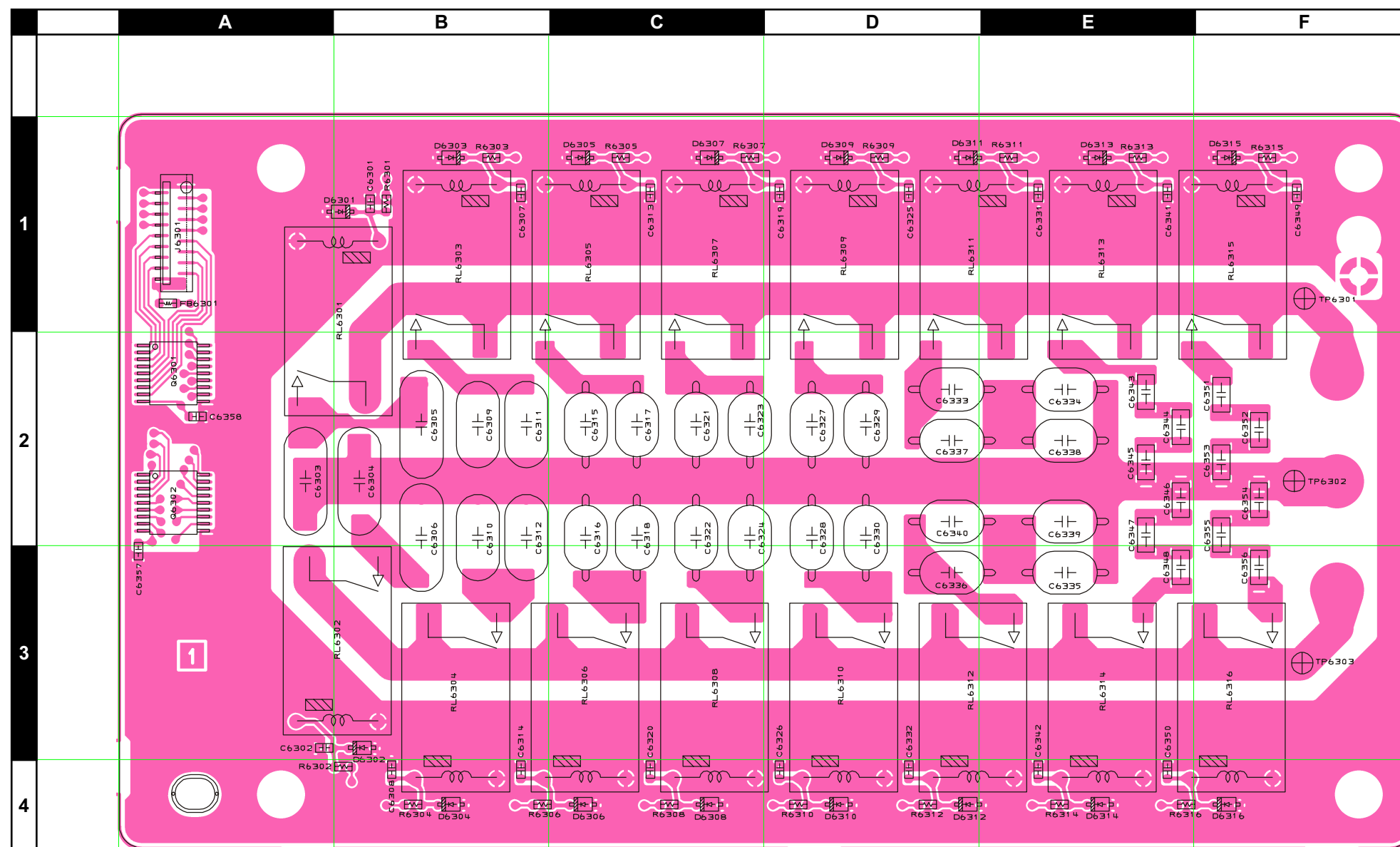

TUNER-C Unit

Parts Layout (Side B)

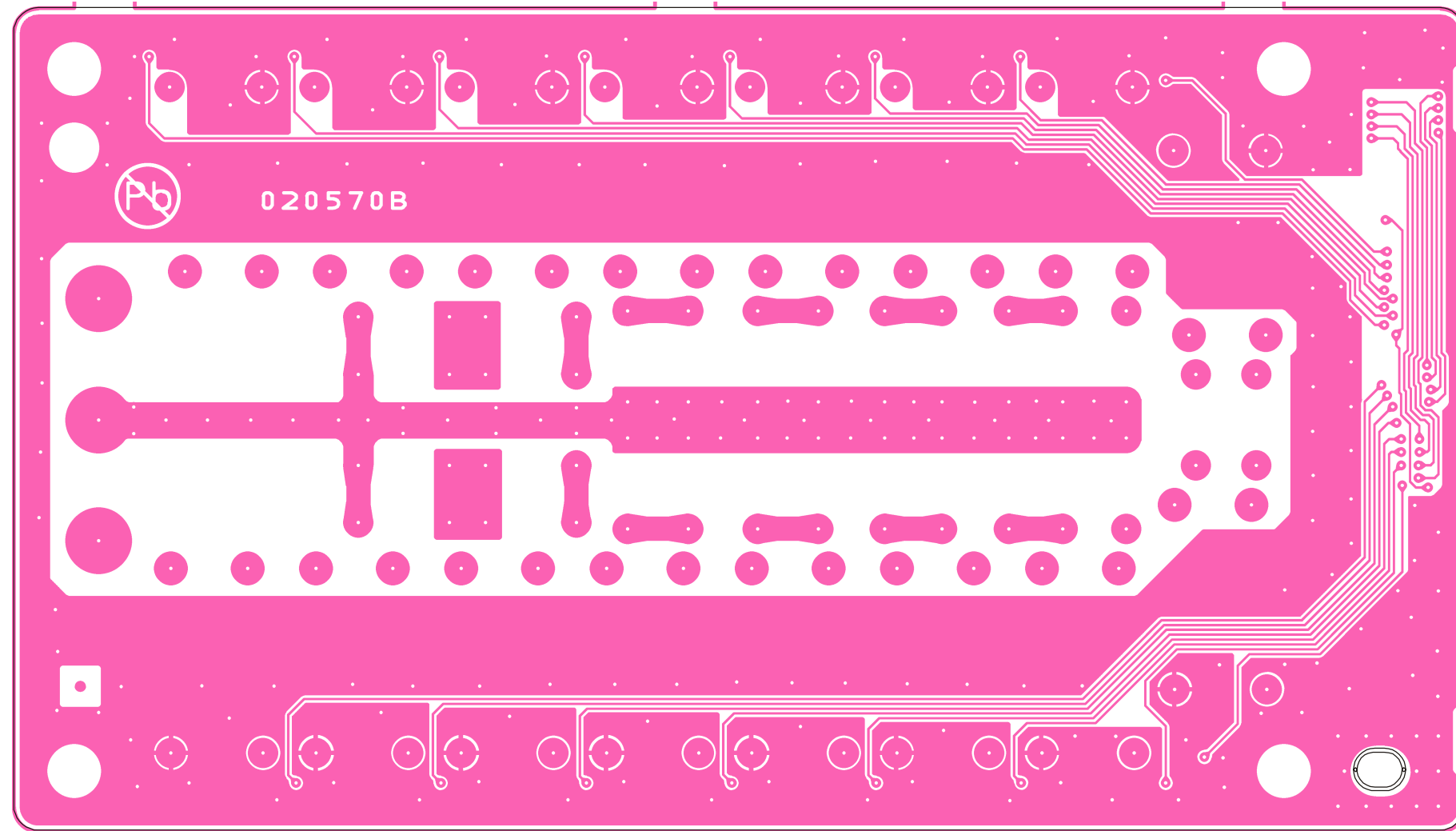

TUNER-C Unit

Parts List

REF	DESCRIPTION	VALUE	V/W	TOL.	MFR'S DESIG	VXSTD P/N	VERS.	LOT	SIDE	LAY ADR
PCB with Components						CB4991001				
	Printed Circuit Board					FR020570B			1-	
C 6301	CHIP CAP.	0.01uF	50V	B	GRM188B11H103KA01D	K22174823		1-	A	B1
C 6302	CHIP CAP.	0.01uF	50V	B	GRM188B11H103KA01D	K22174823		1-	A	A3
C 6303	CERAMIC CAP.	150pF	3KV	SL	CC45SL3FD151JYNN	K00359035		1-	A	A2
C 6304	CERAMIC CAP.	150pF	3KV	SL	CC45SL3FD151JYNN	K00359035		1-	A	B2
C 6305	CERAMIC CAP.	150pF	3KV	SL	CC45SL3FD151JYNN	K00359035		1-	A	B2
C 6306	CERAMIC CAP.	150pF	3KV	SL	CC45SL3FD151JYNN	K00359035		1-	A	B3
C 6307	CHIP CAP.	0.01uF	50V	B	GRM188B11H103KA01D	K22174823		1-	A	B1
C 6308	CHIP CAP.	0.01uF	50V	B	GRM188B11H103KA01D	K22174823		1-	A	B4
C 6309	CERAMIC CAP.	82pF	3KV	SL	CC45SL3FD820JYNN	K00359034		1-	A	B2
C 6310	CERAMIC CAP.	82pF	3KV	SL	CC45SL3FD820JYNN	K00359034		1-	A	B3
C 6311	CERAMIC CAP.	68pF	3KV	SL	CC45SL3FD680JYNN	K00359036		1-	A	B2
C 6312	CERAMIC CAP.	68pF	3KV	SL	CC45SL3FD680JYNN	K00359036		1-	A	B3
C 6313	CHIP CAP.	0.01uF	50V	B	GRM188B11H103KA01D	K22174823		1-	A	C1
C 6314	CHIP CAP.	0.01uF	50V	B	GRM188B11H103KA01D	K22174823		1-	A	B4
C 6315	CERAMIC CAP.	39pF	3KV	SL	CC45SL3FD390JYNN	K00359033		1-	A	C2
C 6316	CERAMIC CAP.	39pF	3KV	SL	CC45SL3FD390JYNN	K00359033		1-	A	C3
C 6317	CERAMIC CAP.	39pF	3KV	SL	CC45SL3FD390JYNN	K00359033		1-	A	C2
C 6318	CERAMIC CAP.	39pF	3KV	SL	CC45SL3FD390JYNN	K00359033		1-	A	C3
C 6319	CHIP CAP.	0.01uF	50V	B	GRM188B11H103KA01D	K22174823		1-	A	D1
C 6320	CHIP CAP.	0.01uF	50V	B	GRM188B11H103KA01D	K22174823		1-	A	C4
C 6321	CERAMIC CAP.	22pF	3KV	SL	CC45SL3FD220JYNN	K00359038		1-	A	C2
C 6322	CERAMIC CAP.	22pF	3KV	SL	CC45SL3FD220JYNN	K00359038		1-	A	C3
C 6323	CERAMIC CAP.	18pF	3KV	SL	CC45SL3FD180JYNN	K00359028		1-	A	C2
C 6324	CERAMIC CAP.	18pF	3KV	SL	CC45SL3FD180JYNN	K00359028		1-	A	C3
C 6325	CHIP CAP.	0.01uF	50V	B	GRM188B11H103KA01D	K22174823		1-	A	D1
C 6326	CHIP CAP.	0.01uF	50V	B	GRM188B11H103KA01D	K22174823		1-	A	D4
C 6327	CERAMIC CAP.	10pF	3KV	SL	CC45SL3FD100JYNN	K00359037		1-	A	D2
C 6328	CERAMIC CAP.	10pF	3KV	SL	CC45SL3FD100JYNN	K00359037		1-	A	D3
C 6329	CERAMIC CAP.	10pF	3KV	SL	CC45SL3FD100JYNN	K00359037		1-	A	D2
C 6330	CERAMIC CAP.	10pF	3KV	SL	CC45SL3FD100JYNN	K00359037		1-	A	D3
C 6331	CHIP CAP.	0.01uF	50V	B	GRM188B11H103KA01D	K22174823		1-	A	E1
C 6332	CHIP CAP.	0.01uF	50V	B	GRM188B11H103KA01D	K22174823		1-	A	D4
C 6333	CERAMIC CAP.	10pF	3KV	SL	CC45SL3FD100JYNN	K00359037		1-	A	E2
C 6334	CERAMIC CAP.	10pF	3KV	SL	CC45SL3FD100JYNN	K00359037		1-	A	E2
C 6335	CERAMIC CAP.	10pF	3KV	SL	CC45SL3FD100JYNN	K00359037		1-	A	E3
C 6336	CERAMIC CAP.	10pF	3KV	SL	CC45SL3FD100JYNN	K00359037		1-	A	D3
C 6337	CERAMIC CAP.	10pF	3KV	SL	CC45SL3FD100JYNN	K00359037		1-	A	E2
C 6338	CERAMIC CAP.	10pF	3KV	SL	CC45SL3FD100JYNN	K00359037		1-	A	E2
C 6339	CERAMIC CAP.	10pF	3KV	SL	CC45SL3FD100JYNN	K00359037		1-	A	E2
C 6340	CERAMIC CAP.	10pF	3KV	SL	CC45SL3FD100JYNN	K00359037		1-	A	D2
C 6341	CHIP CAP.	0.01uF	50V	B	GRM188B11H103KA01D	K22174823		1-	A	E1
C 6342	CHIP CAP.	0.01uF	50V	B	GRM188B11H103KA01D	K22174823		1-	A	E4
C 6343	CHIP CAP.	15pF	500V	CH	CF316CH150J500AT	K22271288		1-	A	E2
C 6344	CHIP CAP.	15pF	500V	CH	CF316CH150J500AT	K22271288		1-	A	E2
C 6345	CHIP CAP.	15pF	500V	CH	CF316CH150J500AT	K22271288		1-	A	E2
C 6346	CHIP CAP.	15pF	500V	CH	CF316CH150J500AT	K22271288		1-	A	E2
C 6347	CHIP CAP.	15pF	500V	CH	CF316CH150J500AT	K22271288		1-	A	E2
C 6348	CHIP CAP.	15pF	500V	CH	CF316CH150J500AT	K22271288		1-	A	E3
C 6349	CHIP CAP.	0.01uF	50V	B	GRM188B11H103KA01D	K22174823		1-	A	F1
C 6350	CHIP CAP.	0.01uF	50V	B	GRM188B11H103KA01D	K22174823		1-	A	E4
C 6351	CHIP CAP.	7pF	500V	CH	CF316CH070D500AT	K22271252		1-	A	F2
C 6352	CHIP CAP.	7pF	500V	CH	CF316CH070D500AT	K22271252		1-	A	F2
C 6353	CHIP CAP.	7pF	500V	CH	CF316CH070D500AT	K22271252		1-	A	F2
C 6354	CHIP CAP.	7pF	500V	CH	CF316CH070D500AT	K22271252		1-	A	F2
C 6355	CHIP CAP.	7pF	500V	CH	CF316CH070D500AT	K22271252		1-	A	F2
C 6356	CHIP CAP.	7pF	500V	CH	CF316CH070D500AT	K22271252		1-	A	F3
C 6357	CHIP CAP.	0.047uF	25V	B	GRM188B11E473KA01D	K22144811		1-	A	A3
C 6358	CHIP CAP.	0.047uF	25V	B	GRM188B11E473KA01D	K22144811		1-	A	A2
D 6301	DIODE				BAS316	G2070716		1-	A	B1
D 6302	DIODE				BAS316	G2070716		1-	A	B3
D 6303	DIODE				BAS316	G2070716		1-	A	B1
D 6304	DIODE				BAS316	G2070716		1-	A	B4
D 6305	DIODE				BAS316	G2070716		1-	A	C1
D 6306	DIODE				BAS316	G2070716		1-	A	C4
D 6307	DIODE				BAS316	G2070716		1-	A	C1
D 6308	DIODE				BAS316	G2070716		1-	A	C4
D 6309	DIODE				BAS316	G2070716		1-	A	D1
D 6310	DIODE				BAS316	G2070716		1-	A	D4
D 6311	DIODE				BAS316	G2070716		1-	A	D1
D 6312	DIODE				BAS316	G2070716		1-	A	D4
D 6313	DIODE				BAS316	G2070716		1-	A	E1

TUNER-C Unit

Parts List

REF	DESCRIPTION	VALUE	V/W	TOL.	MFR'S DESIG	VXSTD P/N	VERS.	LOT	SIDE	LAY ADR
D 6314	DIODE				BAS316	G2070716		1-	A	E4
D 6315	DIODE				BAS316	G2070716		1-	A	F1
D 6316	DIODE				BAS316	G2070716		1-	A	F4
FB6301	FERRITE BEADS				BLM18PG330SN1D	L9190141		1-	A	A1
J 6301	CONNECTOR				18FLT-SM2-TB(LF)(SN)(M)	P1091176		1-	A	A1
JP6301	WIRE ASSY				VIO 57 SIN/R1.25-3	T9318327		1-		
JP6302	WIRE ASSY				VIO 57 SIN/R1.25-3	T9318327		1-		
JP6303	WIRE ASSY				VIO 95 SIN/R1.25-3	T9318328		1-		
Q 6301	IC				TD62783AFNG(5.S.EL)	G1092700		1-	A	A2
Q 6302	IC				TD62783AFNG(5.S.EL)	G1092700		1-	A	A2
R 6301	CHIP RES.	47	1/16W	5%	RMC1/16 470JATP	J24185470		1-	A	B1
R 6302	CHIP RES.	47	1/16W	5%	RMC1/16 470JATP	J24185470		1-	A	B4
R 6303	CHIP RES.	47	1/16W	5%	RMC1/16 470JATP	J24185470		1-	A	B1
R 6304	CHIP RES.	47	1/16W	5%	RMC1/16 470JATP	J24185470		1-	A	B4
R 6305	CHIP RES.	47	1/16W	5%	RMC1/16 470JATP	J24185470		1-	A	C1
R 6306	CHIP RES.	47	1/16W	5%	RMC1/16 470JATP	J24185470		1-	A	B4
R 6307	CHIP RES.	47	1/16W	5%	RMC1/16 470JATP	J24185470		1-	A	C1
R 6308	CHIP RES.	47	1/16W	5%	RMC1/16 470JATP	J24185470		1-	A	C4
R 6309	CHIP RES.	47	1/16W	5%	RMC1/16 470JATP	J24185470		1-	A	D1
R 6310	CHIP RES.	47	1/16W	5%	RMC1/16 470JATP	J24185470		1-	A	D4
R 6311	CHIP RES.	47	1/16W	5%	RMC1/16 470JATP	J24185470		1-	A	E1
R 6312	CHIP RES.	47	1/16W	5%	RMC1/16 470JATP	J24185470		1-	A	D4
R 6313	CHIP RES.	47	1/16W	5%	RMC1/16 470JATP	J24185470		1-	A	E1
R 6314	CHIP RES.	47	1/16W	5%	RMC1/16 470JATP	J24185470		1-	A	E4
R 6315	CHIP RES.	47	1/16W	5%	RMC1/16 470JATP	J24185470		1-	A	F1
R 6316	CHIP RES.	47	1/16W	5%	RMC1/16 470JATP	J24185470		1-	A	E4
RL6301	RELAY		DC12V		JV12S-KS DC12V	M1190205		1-	A	A1
RL6302	RELAY		DC12V		JV12S-KS DC12V	M1190205		1-	A	B3
RL6303	RELAY		DC12V		JV12S-KS DC12V	M1190205		1-	A	B1
RL6304	RELAY		DC12V		JV12S-KS DC12V	M1190205		1-	A	B4
RL6305	RELAY		DC12V		JV12S-KS DC12V	M1190205		1-	A	B1
RL6306	RELAY		DC12V		JV12S-KS DC12V	M1190205		1-	A	C4
RL6307	RELAY		DC12V		JV12S-KS DC12V	M1190205		1-	A	C1
RL6308	RELAY		DC12V		JV12S-KS DC12V	M1190205		1-	A	C4
RL6309	RELAY		DC12V		JV12S-KS DC12V	M1190205		1-	A	D1
RL6310	RELAY		DC12V		JV12S-KS DC12V	M1190205		1-	A	D4
RL6311	RELAY		DC12V		JV12S-KS DC12V	M1190205		1-	A	D1
RL6312	RELAY		DC12V		JV12S-KS DC12V	M1190205		1-	A	E4
RL6313	RELAY		DC12V		JV12S-KS DC12V	M1190205		1-	A	E1
RL6314	RELAY		DC12V		JV12S-KS DC12V	M1190205		1-	A	E4
RL6315	RELAY		DC12V		JV12S-KS DC12V	M1190205		1-	A	E1
RL6316	RELAY		DC12V		JV12S-KS DC12V	M1190205		1-	A	F4

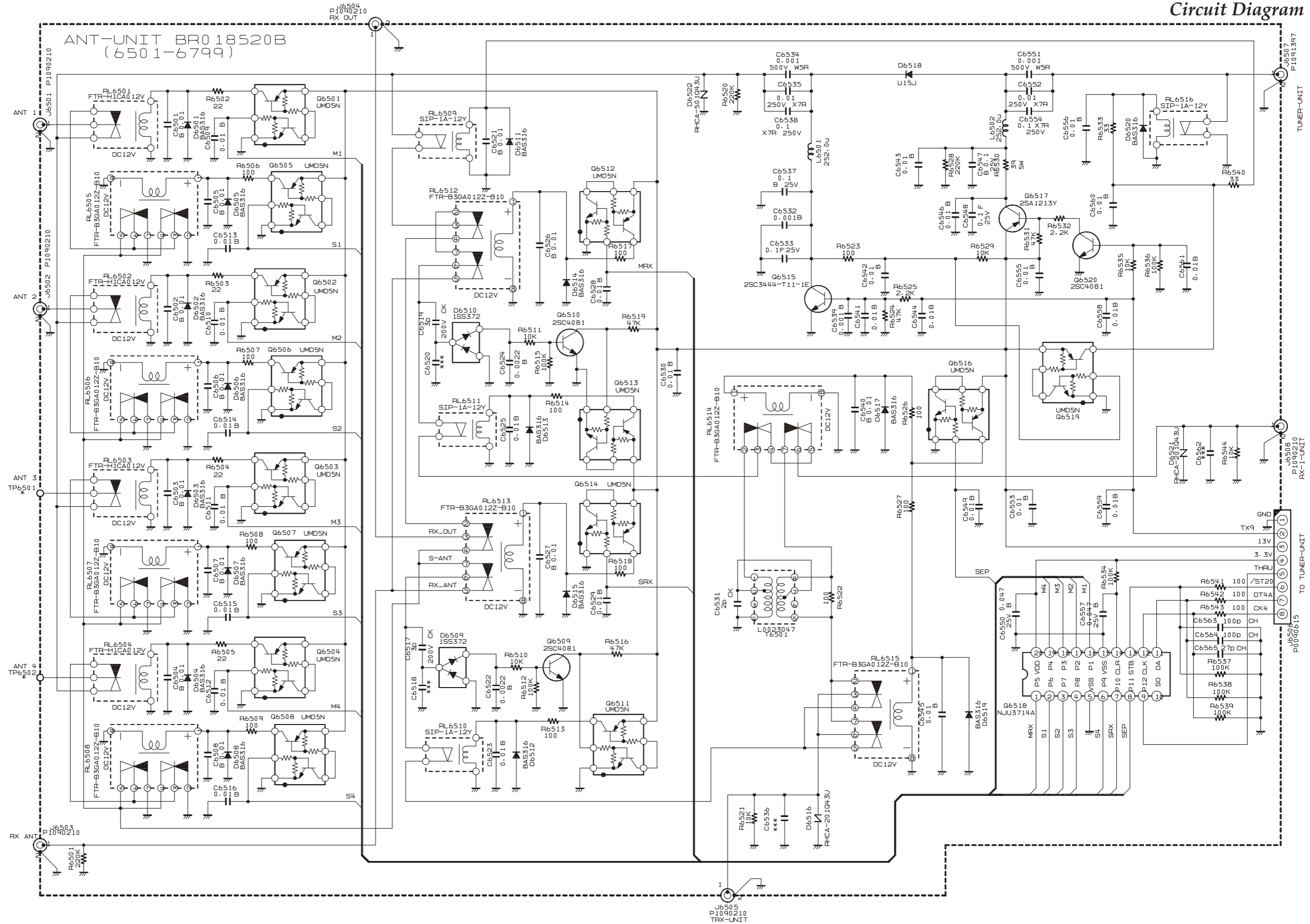

ANT Unit (Lot. 1 ~ 20)

Note

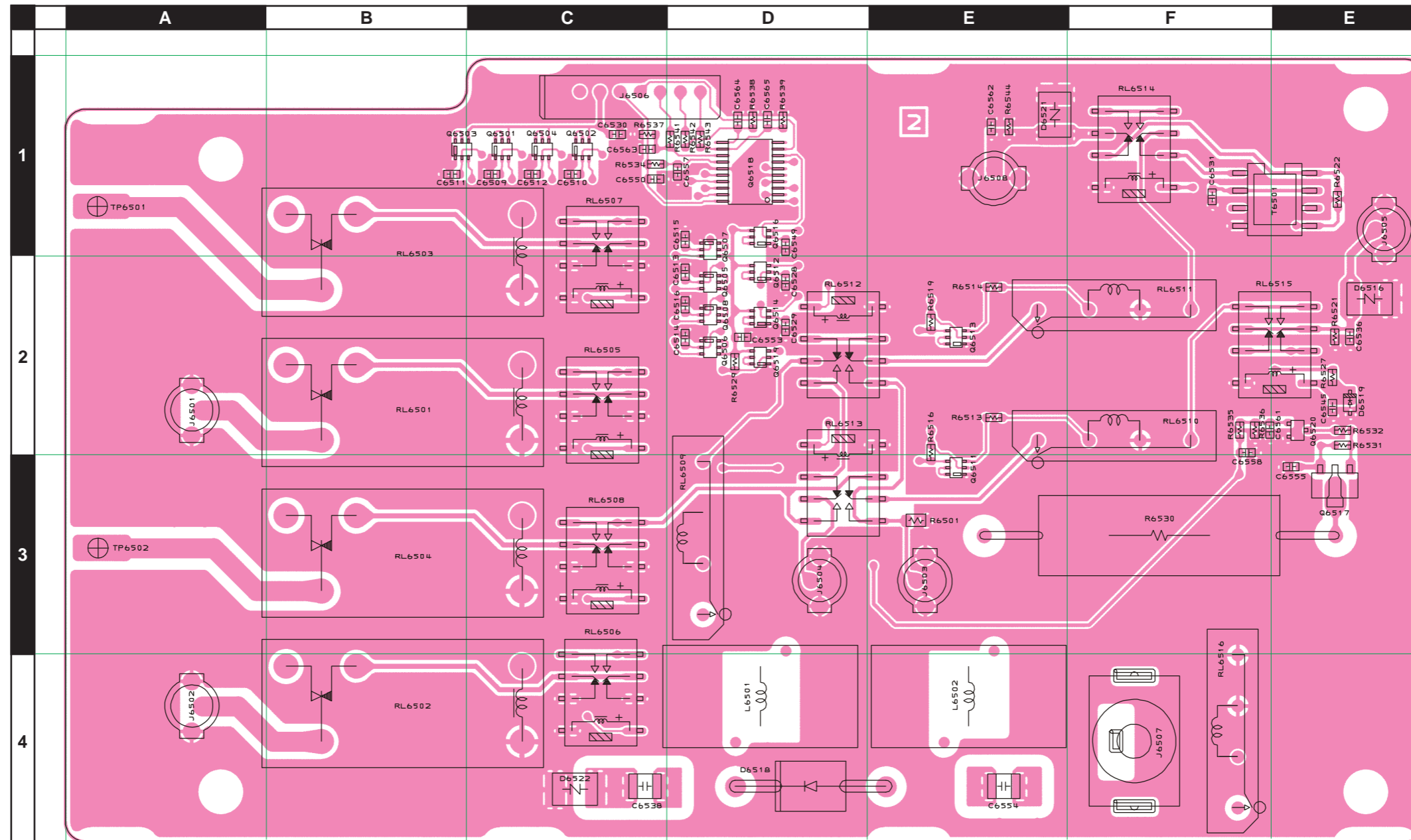

ANT Unit (Lot. 1 ~ 20)

Parts Layout (Side B)

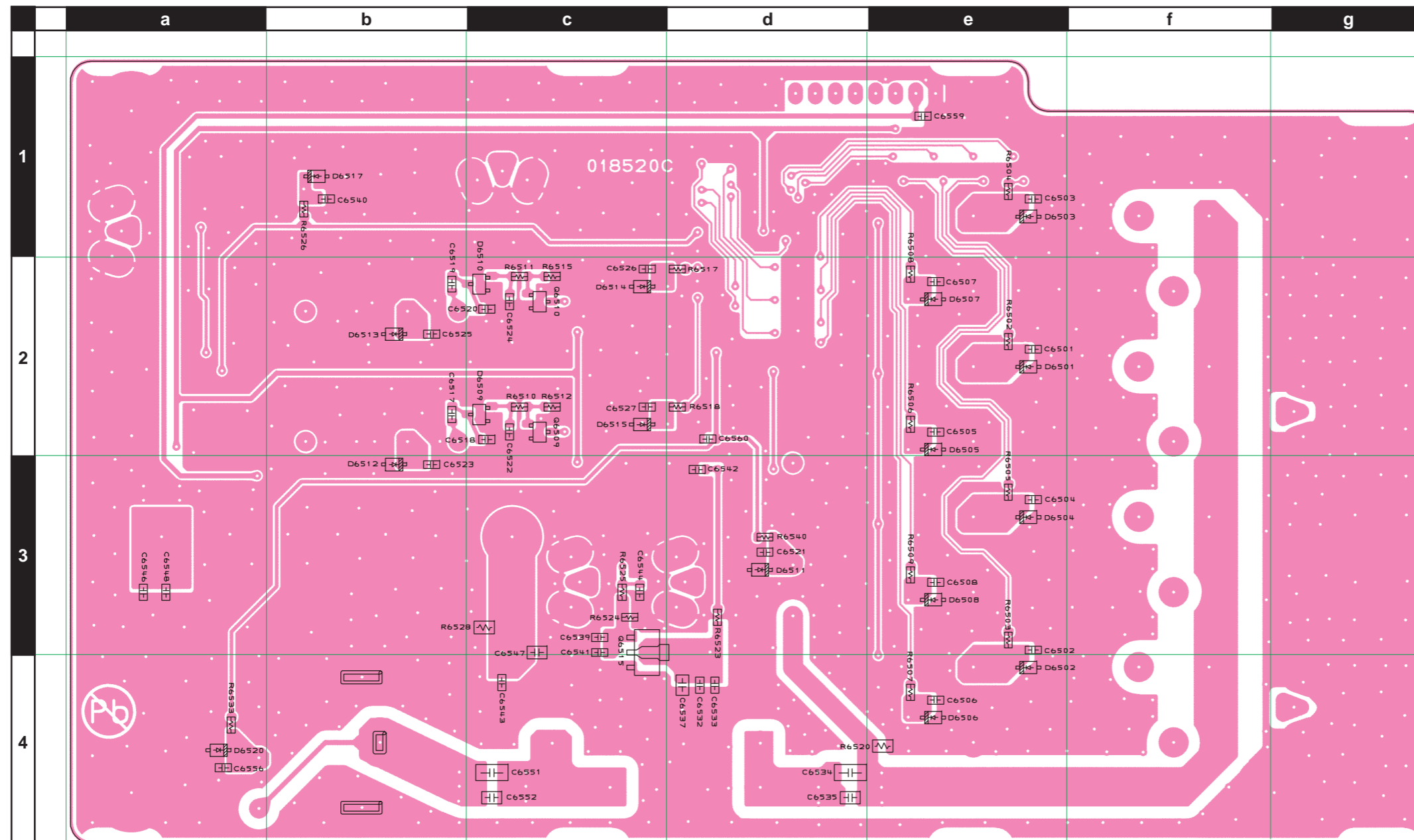

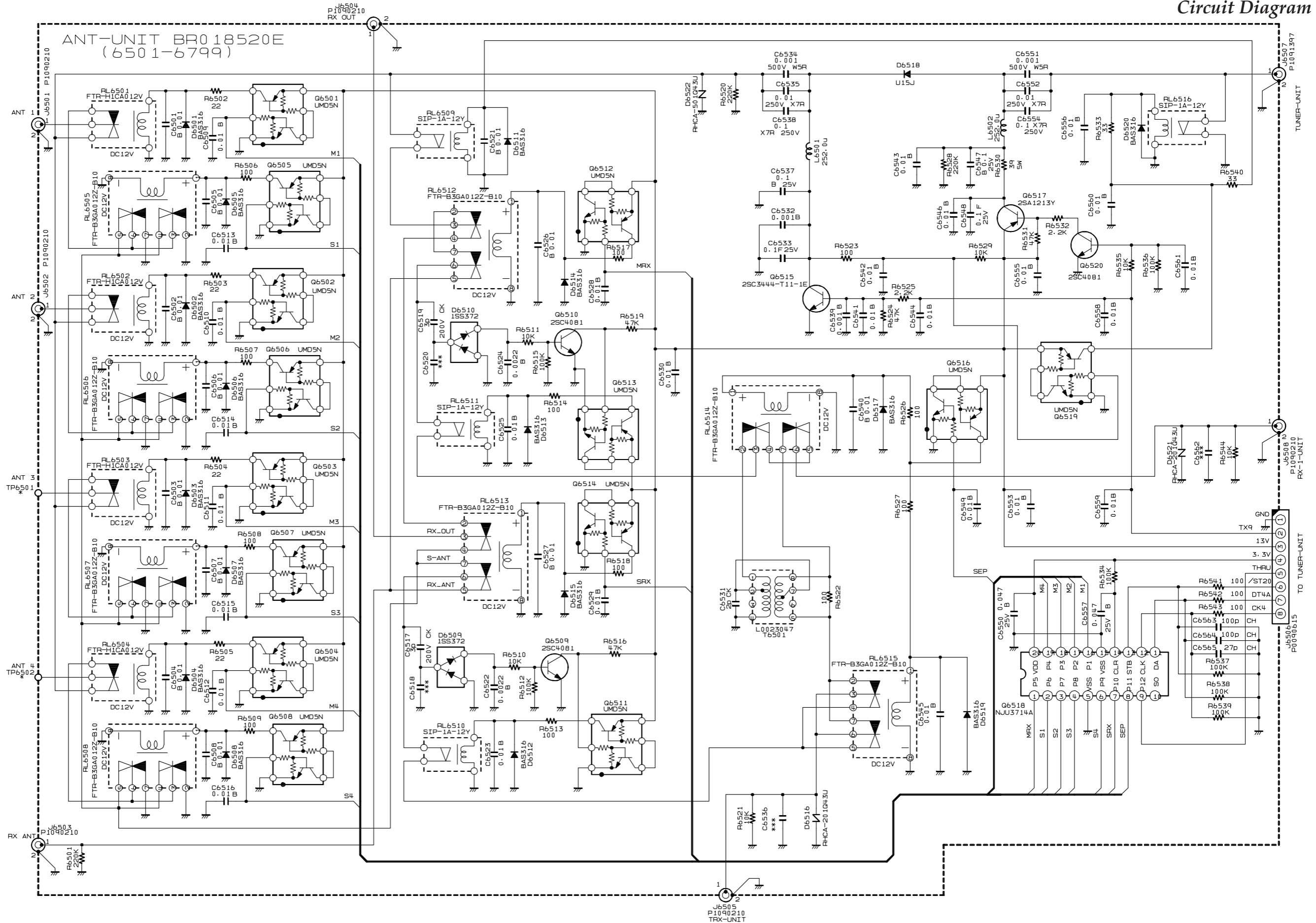

ANT Unit (Lot. 21 ~)

Note

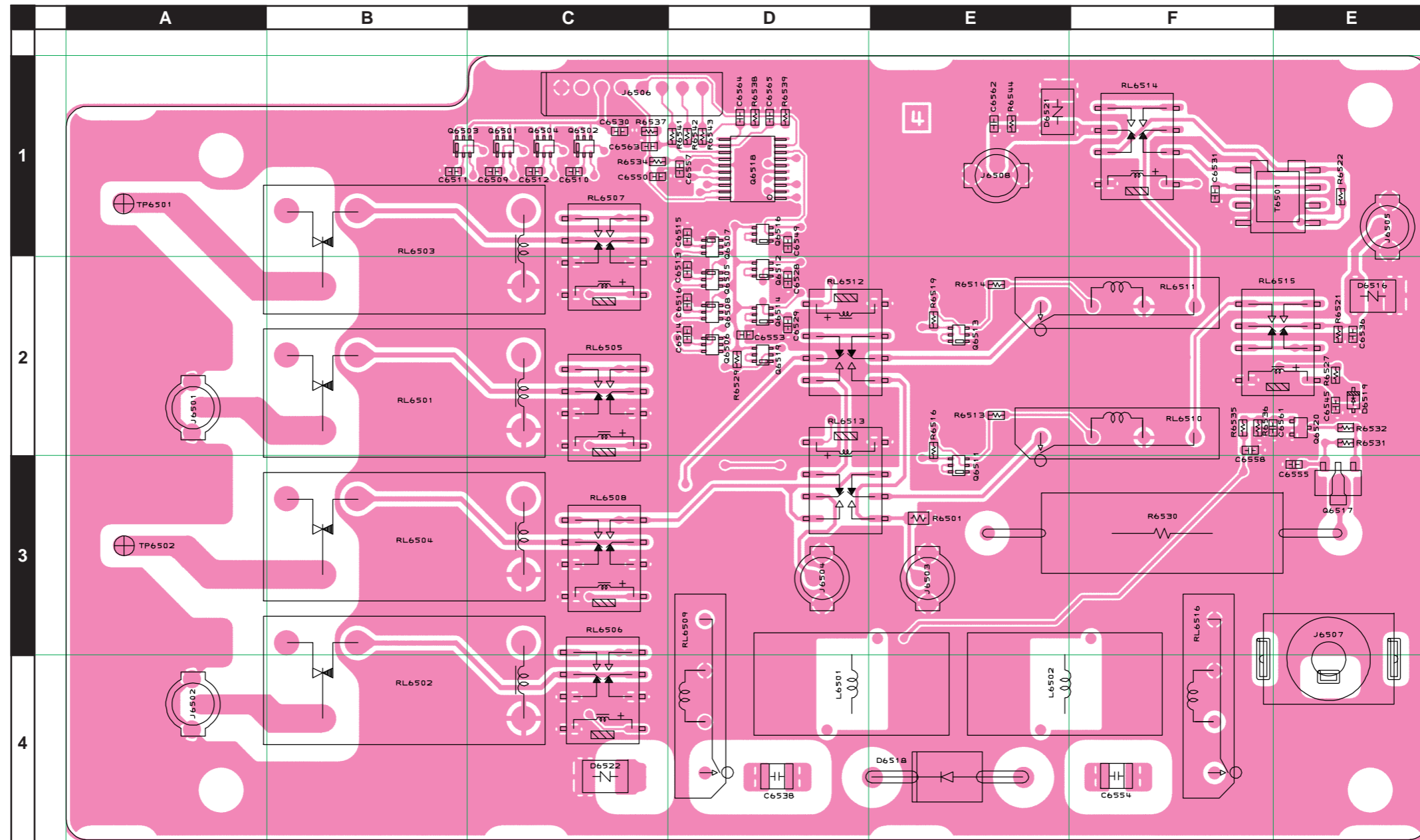

ANT Unit (Lot. 21 ~)

Parts Layout (Side B)

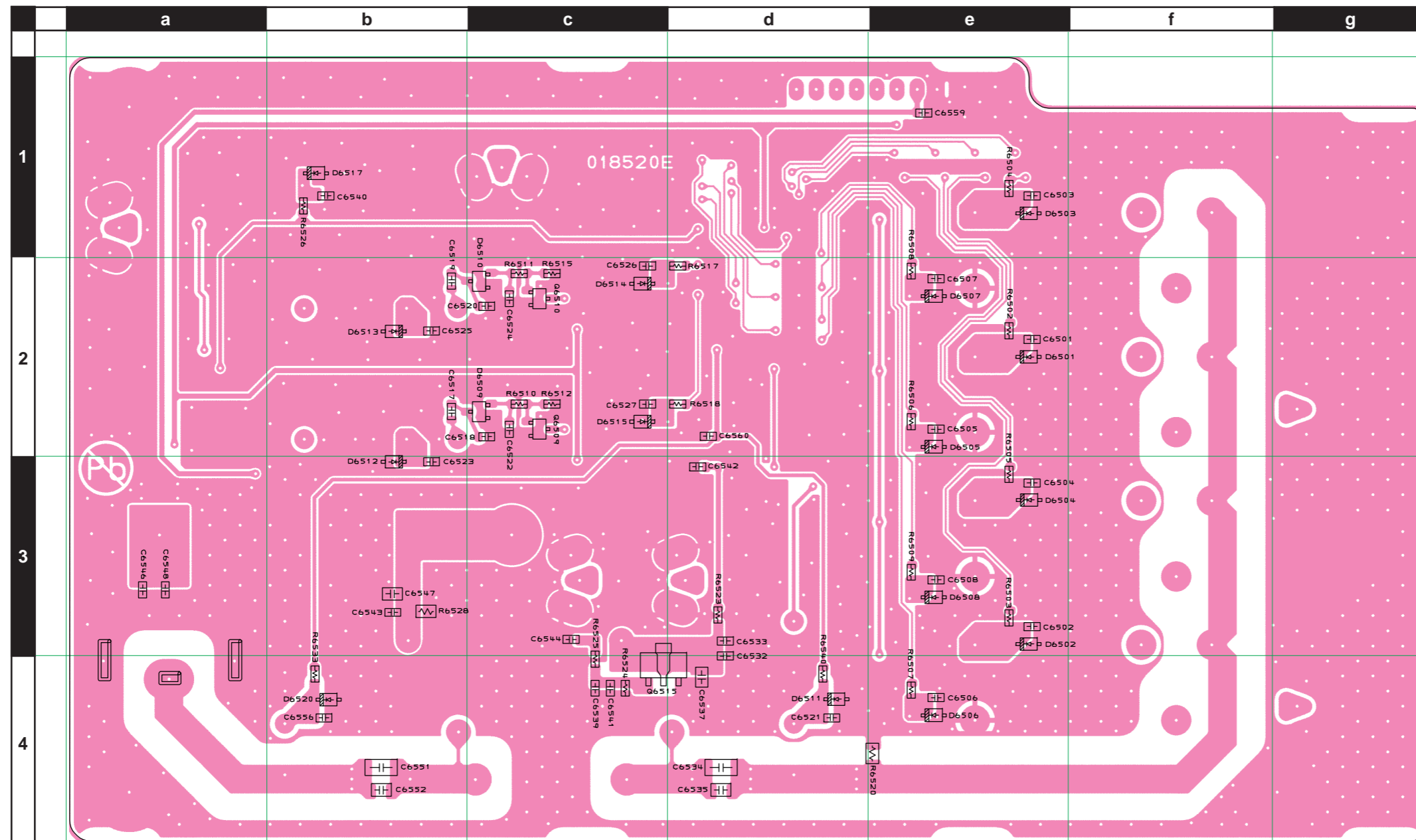

REF	DESCRIPTION	VALUE	V/W	TOL.	MFR'S DESIG	VXSTD P/N	VERS.	LOT	SIDE	LAY ADR
PCB with Components						CB4461001				
	Printed Circuit Board					FR018520C		1-		
	Printed Circuit Board					FR018520E		21-		
C 6501	CHIP CAP.	0.01uF	50V	B	GRM188B11H103KA01D	K22174823		1-	B	e2
C 6502	CHIP CAP.	0.01uF	50V	B	GRM188B11H103KA01D	K22174823		1-	B	e3
C 6503	CHIP CAP.	0.01uF	50V	B	GRM188B11H103KA01D	K22174823		1-	B	e1
C 6504	CHIP CAP.	0.01uF	50V	B	GRM188B11H103KA01D	K22174823		1-	B	e3
C 6505	CHIP CAP.	0.01uF	50V	B	GRM188B11H103KA01D	K22174823		1-	B	e2
C 6506	CHIP CAP.	0.01uF	50V	B	GRM188B11H103KA01D	K22174823		1-	B	e4
C 6507	CHIP CAP.	0.01uF	50V	B	GRM188B11H103KA01D	K22174823		1-	B	e2
C 6508	CHIP CAP.	0.01uF	50V	B	GRM188B11H103KA01D	K22174823		1-	B	e3
C 6509	CHIP CAP.	0.01uF	50V	B	GRM188B11H103KA01D	K22174823		1-	A	C1
C 6510	CHIP CAP.	0.01uF	50V	B	GRM188B11H103KA01D	K22174823		1-	A	C1
C 6511	CHIP CAP.	0.01uF	50V	B	GRM188B11H103KA01D	K22174823		1-	A	B1
C 6512	CHIP CAP.	0.01uF	50V	B	GRM188B11H103KA01D	K22174823		1-	A	C1
C 6513	CHIP CAP.	0.01uF	50V	B	GRM188B11H103KA01D	K22174823		1-	A	D2
C 6514	CHIP CAP.	0.01uF	50V	B	GRM188B11H103KA01D	K22174823		1-	A	D2
C 6515	CHIP CAP.	0.01uF	50V	B	GRM188B11H103KA01D	K22174823		1-	A	D1
C 6516	CHIP CAP.	0.01uF	50V	B	GRM188B11H103KA01D	K22174823		1-	A	D2
C 6517	CHIP CAP.	3pF	200V	CJ	GRM1883C2D3R0CV01D	K22234205		1-	B	b2
C 6519	CHIP CAP.	3pF	200V	CJ	GRM1883C2D3R0CV01D	K22234205		1-	B	b2
C 6521	CHIP CAP.	0.01uF	50V	B	GRM188B11H103KA01D	K22174823		1-	B	d4
C 6522	CHIP CAP.	0.0022uF	50V	B	GRM188B11H222KA01D	K22174822		1-	B	c2
C 6523	CHIP CAP.	0.01uF	50V	B	GRM188B11H103KA01D	K22174823		1-	B	b3
C 6524	CHIP CAP.	0.0022uF	50V	B	GRM188B11H222KA01D	K22174822		1-	B	c2
C 6525	CHIP CAP.	0.01uF	50V	B	GRM188B11H103KA01D	K22174823		1-	B	b2
C 6526	CHIP CAP.	0.01uF	50V	B	GRM188B11H103KA01D	K22174823		1-	B	c2
C 6527	CHIP CAP.	0.01uF	50V	B	GRM188B11H103KA01D	K22174823		1-	B	c2
C 6528	CHIP CAP.	0.01uF	50V	B	GRM188B11H103KA01D	K22174823		1-	A	D2
C 6529	CHIP CAP.	0.01uF	50V	B	GRM188B11H103KA01D	K22174823		1-	A	D2
C 6530	CHIP CAP.	0.01uF	50V	B	GRM188B11H103KA01D	K22174823		1-	A	C1
C 6531	CHIP CAP.	2pF	50V	CK	GRM1884C1H2R0CZ01D	K22174203		1-	A	F1
C 6532	CHIP CAP.	0.001uF	50V	B	GRM188B11H102KA01D	K22174821		1-	B	d3
C 6533	CHIP CAP.	0.1uF	25V	F	GRM188F11E104ZA01D	K22145001		1-	B	d3
C 6534	CHIP CAP.	0.001uF	500V	W5R	CF316W5R102K500AT	K22271802		1-	B	d4
C 6535	CHIP CAP.	0.01uF	250V	X7R	GRM21BR72E103KW03L	K22240801		1-	B	d4
C 6537	CHIP CAP.	0.1uF	25V	B	GRM21BB11E104KA01L	K22140811		1-	B	d4
C 6538	CHIP CAP.	0.1uF	250V	X7R	GRM32DR72E104KW01L	K22245801		1-	A	D4
C 6539	CHIP CAP.	0.001uF	50V	B	GRM188B11H102KA01D	K22174821		1-	B	c4
C 6540	CHIP CAP.	0.01uF	50V	B	GRM188B11H103KA01D	K22174823		1-	B	b1
C 6541	CHIP CAP.	0.01uF	50V	B	GRM188B11H103KA01D	K22174823		1-	B	c4
C 6542	CHIP CAP.	0.01uF	50V	B	GRM188B11H103KA01D	K22174823		1-	B	d3
C 6543	CHIP CAP.	0.01uF	50V	B	GRM188B11H103KA01D	K22174823		1-	B	b3
C 6544	CHIP CAP.	0.01uF	50V	B	GRM188B11H103KA01D	K22174823		1-	B	c3
C 6545	CHIP CAP.	0.01uF	50V	B	GRM188B11H103KA01D	K22174823		1-	A	G2
C 6546	CHIP CAP.	0.01uF	50V	B	GRM188B11H103KA01D	K22174823		1-	B	a3
C 6547	CHIP CAP.	0.1uF	25V	B	GRM21BB11E104KA01L	K22140811		1-	B	b3
C 6548	CHIP CAP.	0.1uF	25V	F	GRM188F11E104ZA01D	K22145001		1-	B	a3
C 6549	CHIP CAP.	0.01uF	50V	B	GRM188B11H103KA01D	K22174823		1-	A	D1
C 6550	CHIP CAP.	0.047uF	25V	B	GRM188B11E473KA01D	K22144811		1-	A	C1
C 6551	CHIP CAP.	0.001uF	500V	W5R	CF316W5R102K500AT	K22271802		1-	B	b4
C 6552	CHIP CAP.	0.01uF	250V	X7R	GRM21BR72E103KW03L	K22240801		1-	B	b4
C 6553	CHIP CAP.	0.01uF	50V	B	GRM188B11H103KA01D	K22174823		1-	A	D2
C 6554	CHIP CAP.	0.1uF	250V	X7R	GRM32DR72E104KW01L	K22245801		1-	A	F4
C 6555	CHIP CAP.	0.01uF	50V	B	GRM188B11H103KA01D	K22174823		1-	A	G3
C 6556	CHIP CAP.	0.01uF	50V	B	GRM188B11H103KA01D	K22174823		1-	B	b4
C 6557	CHIP CAP.	0.047uF	25V	B	GRM188B11E473KA01D	K22144811		1-	A	D1
C 6558	CHIP CAP.	0.01uF	50V	B	GRM188B11H103KA01D	K22174823		1-	A	F2
C 6559	CHIP CAP.	0.01uF	50V	B	GRM188B11H103KA01D	K22174823		1-	B	e1
C 6560	CHIP CAP.	0.01uF	50V	B	GRM188B11H103KA01D	K22174823		1-	B	d2
C 6561	CHIP CAP.	0.01uF	50V	B	GRM188B11H103KA01D	K22174823		1-	A	G2
C 6563	CHIP CAP.	100pF	50V	CH	GRM1882C1H101JA01D	K22174235		1-	A	C1
C 6564	CHIP CAP.	100pF	50V	CH	GRM1882C1H101JA01D	K22174235		1-	A	D1
C 6565	CHIP CAP.	27pF	50V	CH	GRM1882C1H270JA01D	K22174221		1-	A	D1
D 6501	DIODE				BAS316	G2070716		1-	B	e2
D 6502	DIODE				BAS316	G2070716		1-	B	e3
D 6503	DIODE				BAS316	G2070716		1-	B	e1
D 6504	DIODE				BAS316	G2070716		1-	B	e3
D 6505	DIODE				BAS316	G2070716		1-	B	e2
D 6506	DIODE				BAS316	G2070716		1-	B	e4
D 6507	DIODE				BAS316	G2070716		1-	B	e2
D 6508	DIODE				BAS316	G2070716		1-	B	e3
D 6509	DIODE				1SS372(TE85R.F)	G2070632		1-	B	c2

ANT Unit

Parts List

REF	DESCRIPTION	VALUE	V/W	TOL.	MFR'S DESIG	VXSTD P/N	VERS.	LOT	SIDE	LAY ADR
D 6510	DIODE				1SS372(TE85R.F)	G2070632		1-	B	c2
D 6511	DIODE				BAS316	G2070716		1-	B	d4
D 6512	DIODE				BAS316	G2070716		1-	B	b3
D 6513	DIODE				BAS316	G2070716		1-	B	b2
D 6514	DIODE				BAS316	G2070716		1-	B	c2
D 6515	DIODE				BAS316	G2070716		1-	B	c2
D 6516	SURGE ABSORBER				RHCA-201Q43U	Q9000825		1-	A	G2
D 6517	DIODE				BAS316	G2070716		1-	B	b1
D 6518	DIODE				U15J	G2090572		1-	A	E4
D 6519	DIODE				BAS316	G2070716		1-	A	G2
D 6520	DIODE				BAS316	G2070716		1-	B	b4
D 6521	SURGE ABSORBER				RHCA-201Q43U	Q9000825		1-	A	E1
D 6522	SURGE ABSORBER				RHCA-501Q43U	Q9000922		1-	A	C4
J 6501	CONNECTOR				TMP-J01X-V6	P1090210		1-	A	A2
J 6502	CONNECTOR				TMP-J01X-V6	P1090210		1-	A	A4
J 6503	CONNECTOR				TMP-J01X-V6	P1090210		1-	A	E3
J 6504	CONNECTOR				TMP-J01X-V6	P1090210		1-	A	D3
J 6505	CONNECTOR				TMP-J01X-V6	P1090210		1-	A	G1
J 6506	CONNECTOR				SB20-08WS	P0090615		1-	A	C1
J 6507	CONNECTOR				CTP-106E	P1091397		1-	A	G4
J 6508	CONNECTOR				TMP-J01X-V6	P1090210		1-	A	E1
L 6501	TOROIDAL COIL	252uH			252.0U D12A TR16	L0022881A		1-	A	E3
L 6502	TOROIDAL COIL	252uH			252.0U D12A TR16	L0022881A		1-	A	F3
Q 6501	TRANSISTOR				UMD5N TR	G3070343		1-	A	C1
Q 6502	TRANSISTOR				UMD5N TR	G3070343		1-	A	C1
Q 6503	TRANSISTOR				UMD5N TR	G3070343		1-	A	B1
Q 6504	TRANSISTOR				UMD5N TR	G3070343		1-	A	C1
Q 6505	TRANSISTOR				UMD5N TR	G3070343		1-	A	D2
Q 6506	TRANSISTOR				UMD5N TR	G3070343		1-	A	D2
Q 6507	TRANSISTOR				UMD5N TR	G3070343		1-	A	D1
Q 6508	TRANSISTOR				UMD5N TR	G3070343		1-	A	D2
Q 6509	TRANSISTOR				2SC4081 T106	G3340818		1-	B	c2
Q 6510	TRANSISTOR				2SC4081 T106	G3340818		1-	B	c2
Q 6511	TRANSISTOR				UMD5N TR	G3070343		1-	A	E3
Q 6512	TRANSISTOR				UMD5N TR	G3070343		1-	A	D2
Q 6513	TRANSISTOR				UMD5N TR	G3070343		1-	A	E2
Q 6514	TRANSISTOR				UMD5N TR	G3070343		1-	A	D2
Q 6515	TRANSISTOR				2SC3444-T11-1E	G3334448E		1-	B	c4
Q 6516	TRANSISTOR				UMD5N TR	G3070343		1-	A	D1
Q 6517	TRANSISTOR				2SA1213Y(TE12R.CF)	G3112137Y		1-	A	G3
Q 6518	IC				NJU3714A(TAPE)	G1094291		1-	A	D1
Q 6519	TRANSISTOR				UMD5N TR	G3070343		1-	A	D2
Q 6520	TRANSISTOR				2SC4081 T106	G3340818		1-	A	G2
R 6501	CHIP RES.	220k	1/10W	5%	RMC1/10T 224J	J24205224		1-	A	E3
R 6502	CHIP RES.	22	1/16W	5%	RMC1/16 220JATP	J24185220		1-	B	e2
R 6503	CHIP RES.	22	1/16W	5%	RMC1/16 220JATP	J24185220		1-	B	e3
R 6504	CHIP RES.	22	1/16W	5%	RMC1/16 220JATP	J24185220		1-	B	e1
R 6505	CHIP RES.	22	1/16W	5%	RMC1/16 220JATP	J24185220		1-	B	e3
R 6506	CHIP RES.	100	1/16W	5%	RMC1/16 101JATP	J24185101		1-	B	e2
R 6507	CHIP RES.	100	1/16W	5%	RMC1/16 101JATP	J24185101		1-	B	e4
R 6508	CHIP RES.	100	1/16W	5%	RMC1/16 101JATP	J24185101		1-	B	e2
R 6509	CHIP RES.	100	1/16W	5%	RMC1/16 101JATP	J24185101		1-	B	e3
R 6510	CHIP RES.	10k	1/16W	5%	RMC1/16 103JATP	J24185103		1-	B	c2
R 6511	CHIP RES.	10k	1/16W	5%	RMC1/16 103JATP	J24185103		1-	B	c2
R 6512	CHIP RES.	100k	1/16W	5%	RMC1/16 104JATP	J24185104		1-	B	c2
R 6513	CHIP RES.	100	1/16W	5%	RMC1/16 101JATP	J24185101		1-	A	E2
R 6514	CHIP RES.	100	1/16W	5%	RMC1/16 101JATP	J24185101		1-	A	E2
R 6515	CHIP RES.	100k	1/16W	5%	RMC1/16 104JATP	J24185104		1-	B	c2
R 6516	CHIP RES.	47k	1/16W	5%	RMC1/16 473JATP	J24185473		1-	A	E2
R 6517	CHIP RES.	100	1/16W	5%	RMC1/16 101JATP	J24185101		1-	B	d2
R 6518	CHIP RES.	100	1/16W	5%	RMC1/16 101JATP	J24185101		1-	B	d2
R 6519	CHIP RES.	47k	1/16W	5%	RMC1/16 473JATP	J24185473		1-	A	E2
R 6520	CHIP RES.	220k	1/10W	5%	RMC1/10T 224J	J24205224		1-	B	d4
R 6521	CHIP RES.	10k	1/16W	5%	RMC1/16 103JATP	J24185103		1-	A	G2
R 6522	CHIP RES.	100	1/16W	5%	RMC1/16 101JATP	J24185101		1-	A	G1
R 6523	CHIP RES.	100	1/16W	5%	RMC1/16 101JATP	J24185101		1-	B	d3
R 6524	CHIP RES.	47k	1/16W	5%	RMC1/16 473JATP	J24185473		1-	B	c4
R 6525	CHIP RES.	2.2k	1/16W	5%	RMC1/16 222JATP	J24185222		1-	B	c3
R 6526	CHIP RES.	100	1/16W	5%	RMC1/16 101JATP	J24185101		1-	B	b1
R 6527	CHIP RES.	100	1/16W	5%	RMC1/16 101JATP	J24185101		1-	A	G2
R 6528	CHIP RES.	220k	1/10W	5%	RMC1/10T 224J	J24205224		1-	B	b3
R 6529	CHIP RES.	10k	1/16W	5%	RMC1/16 103JATP	J24185103		1-	A	D2
R 6530	METAL FILM RES.	39	5W	5%	ERG-5SJ390	J22379006		1-	A	G3

ANT Unit

Parts List

REF	DESCRIPTION	VALUE	V/W	TOL.	MFR'S DESIG	VXSTD P/N	VERS.	LOT	SIDE	LAY ADR
R 6531	CHIP RES.	47k	1/16W	5%	RMC1/16 473JATP	J24185473		1-	A	G2
R 6532	CHIP RES.	2.2k	1/16W	5%	RMC1/16 222JATP	J24185222		1-	A	G2
R 6533	CHIP RES.	33	1/16W	5%	RMC1/16 330JATP	J24185330		1-	B	b4
R 6534	CHIP RES.	100k	1/16W	5%	RMC1/16 104JATP	J24185104		1-	A	C1
R 6535	CHIP RES.	10k	1/16W	5%	RMC1/16 103JATP	J24185103		1-	A	F2
R 6536	CHIP RES.	100k	1/16W	5%	RMC1/16 104JATP	J24185104		1-	A	F2
R 6537	CHIP RES.	100k	1/16W	5%	RMC1/16 104JATP	J24185104		1-	A	C1
R 6538	CHIP RES.	100k	1/16W	5%	RMC1/16 104JATP	J24185104		1-	A	D1
R 6539	CHIP RES.	100k	1/16W	5%	RMC1/16 104JATP	J24185104		1-	A	D1
R 6540	CHIP RES.	33	1/16W	5%	RMC1/16 330JATP	J24185330		1-	B	d4
R 6541	CHIP RES.	100	1/16W	5%	RMC1/16 101JATP	J24185101		1-	A	D1
R 6542	CHIP RES.	100	1/16W	5%	RMC1/16 101JATP	J24185101		1-	A	D1
R 6543	CHIP RES.	100	1/16W	5%	RMC1/16 101JATP	J24185101		1-	A	D1
R 6544	CHIP RES.	10k	1/16W	5%	RMC1/16 103JATP	J24185103		1-	A	E1
RL6501	RELAY		DC12V		FTR-H1CA012V DC12V	M1190148		1-	A	B2
RL6502	RELAY		DC12V		FTR-H1CA012V DC12V	M1190148		1-	A	B4
RL6503	RELAY		DC12V		FTR-H1CA012V DC12V	M1190148		1-	A	B2
RL6504	RELAY		DC12V		FTR-H1CA012V DC12V	M1190148		1-	A	B3
RL6505	RELAY		DC12V		FTR-B3GA012Z-B10 DC12V	M1190201		1-	A	C2
RL6506	RELAY		DC12V		FTR-B3GA012Z-B10 DC12V	M1190201		1-	A	C4
RL6507	RELAY		DC12V		FTR-B3GA012Z-B10 DC12V	M1190201		1-	A	C2
RL6508	RELAY		DC12V		FTR-B3GA012Z-B10 DC12V	M1190201		1-	A	C3
RL6509	REED RELAY				SIP-1A-12Y	M1190202		1-	A	D4
RL6510	REED RELAY				SIP-1A-12Y	M1190202		1-	A	F2
RL6511	REED RELAY				SIP-1A-12Y	M1190202		1-	A	F2
RL6512	RELAY		DC12V		FTR-B3GA012Z-B10 DC12V	M1190201		1-	A	D2
RL6513	RELAY		DC12V		FTR-B3GA012Z-B10 DC12V	M1190201		1-	A	D3
RL6514	RELAY		DC12V		FTR-B3GA012Z-B10 DC12V	M1190201		1-	A	F1
RL6515	RELAY		DC12V		FTR-B3GA012Z-B10 DC12V	M1190201		1-	A	G2
RL6516	REED RELAY				SIP-1A-12Y	M1190202		1-	A	F4
T 6501	BALUN TRANSFORMERS				070812736D	L0023047		1-	A	G1

ANT Unit

Note

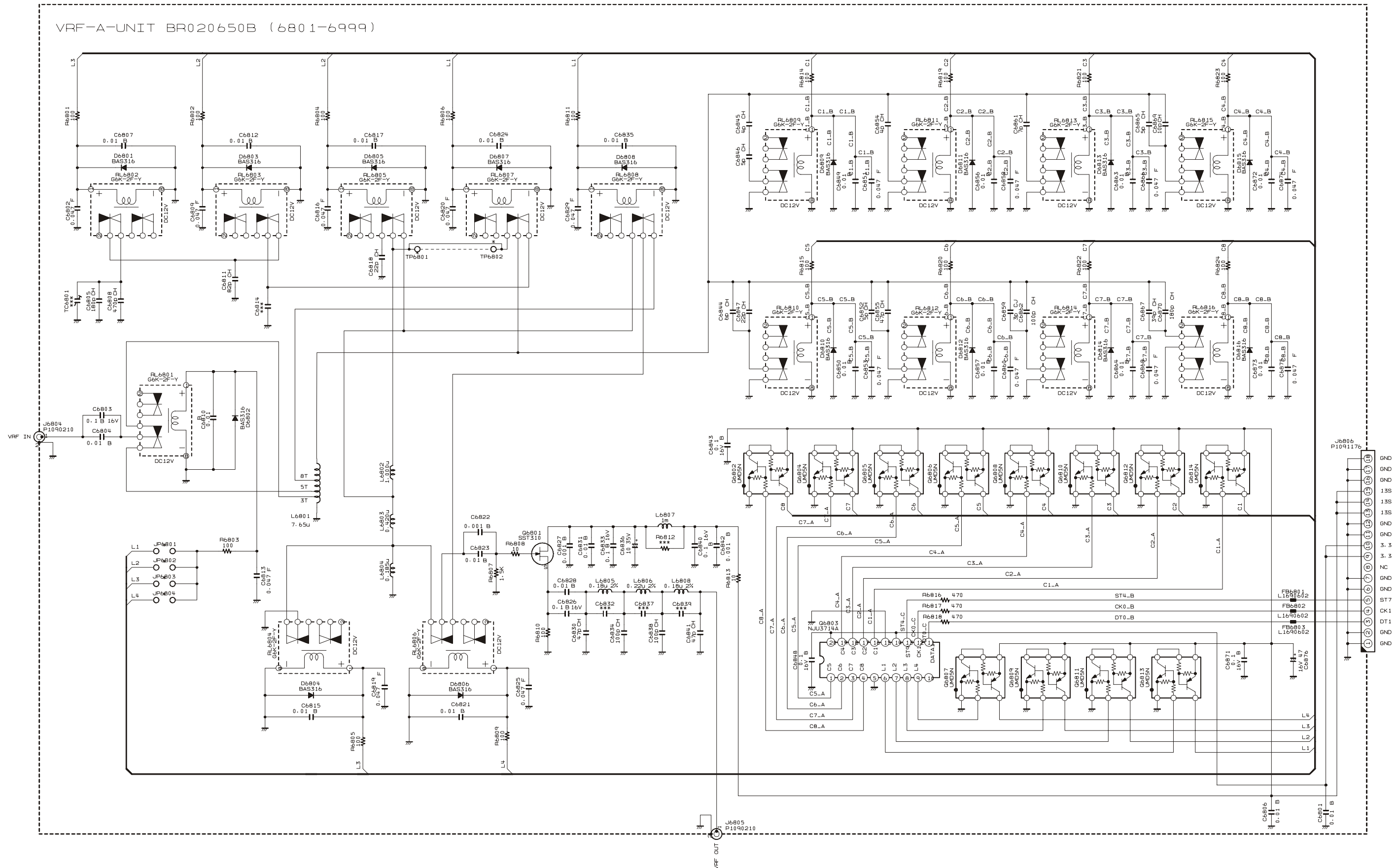

VRF-A Unit (VFO-A)

Parts Layout

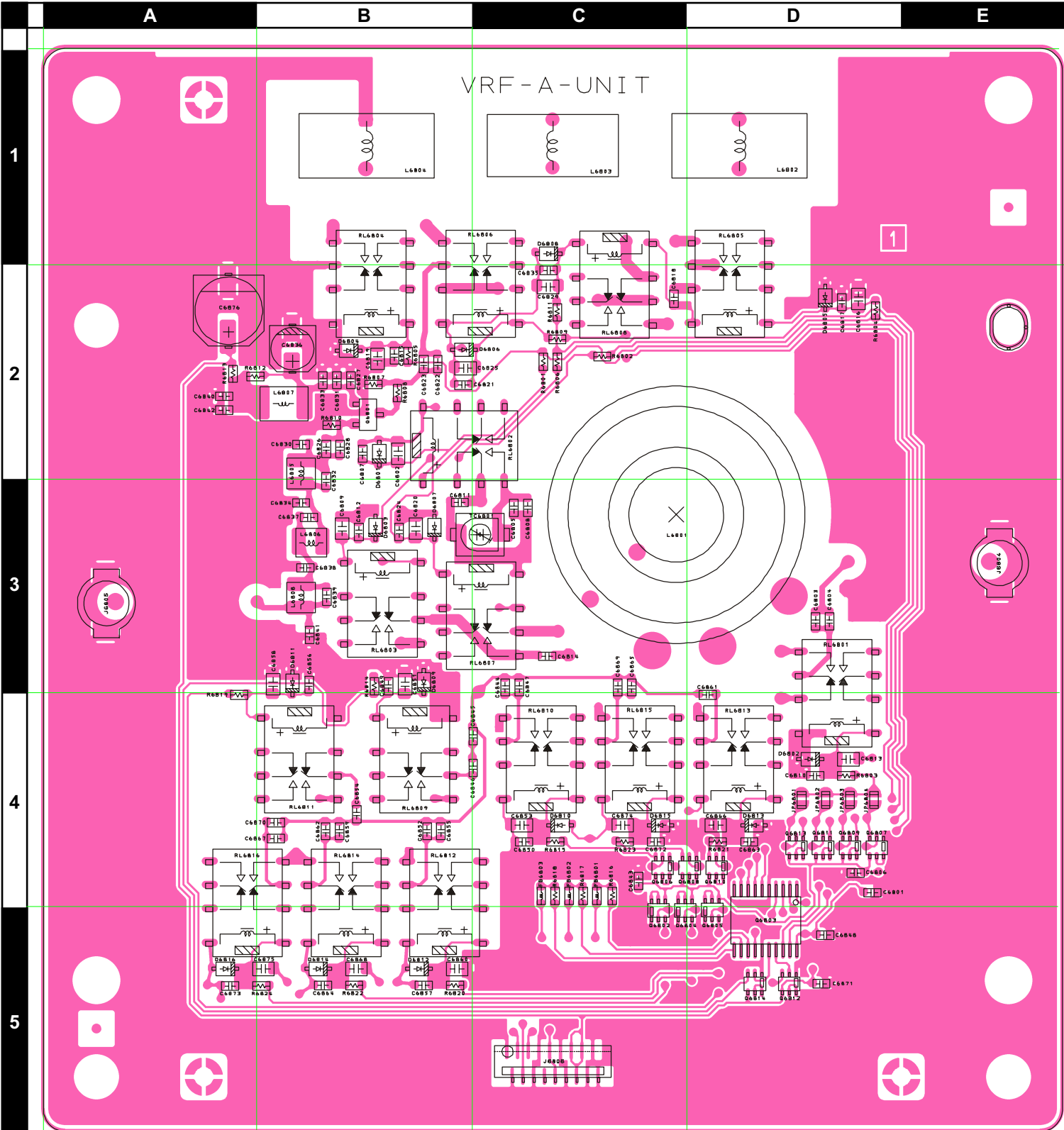

Side A

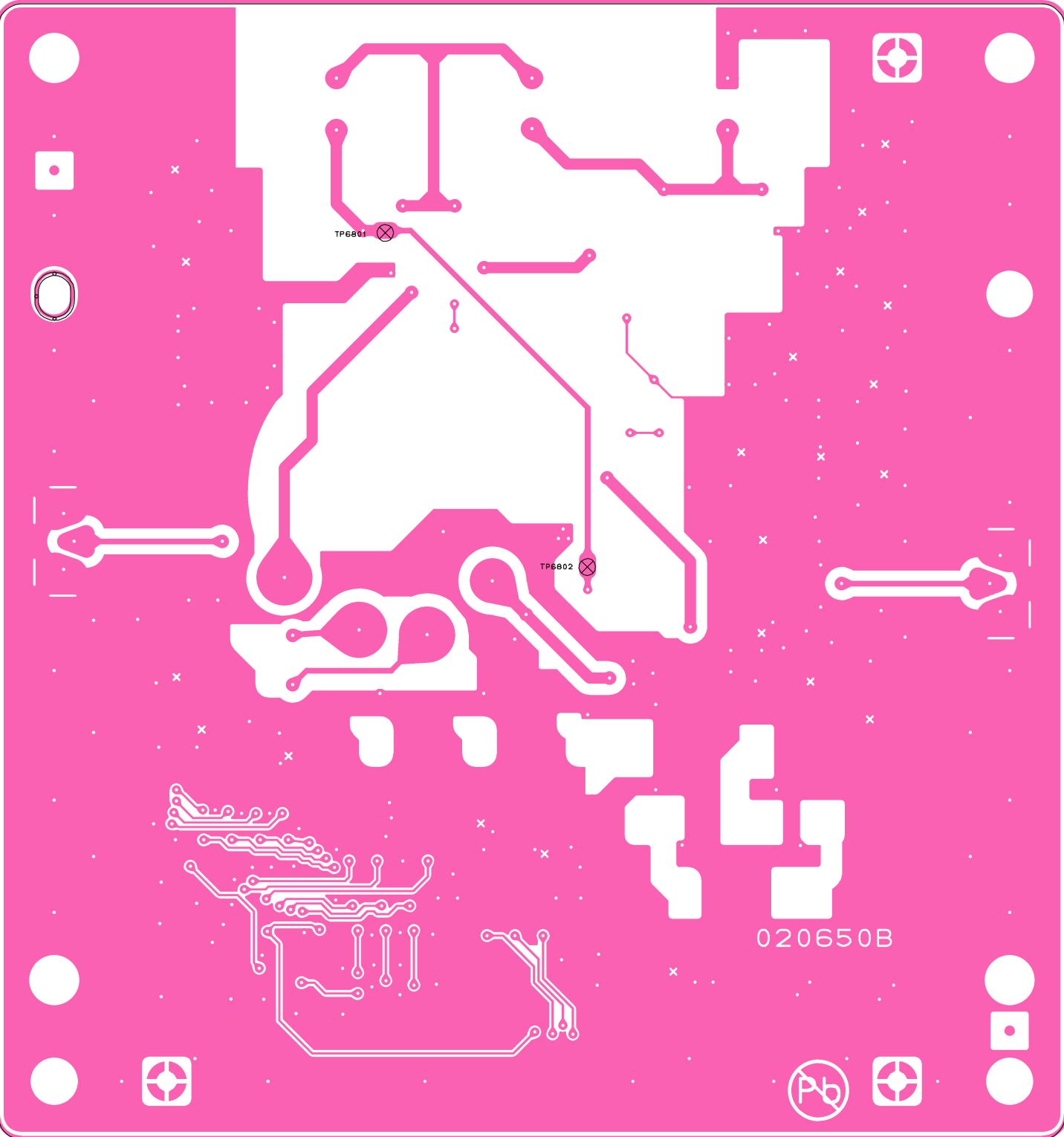

Side B

VRF-A Unit (VFO-A)

Parts List

REF	DESCRIPTION	VALUE	V/W	TOL.	MFR'S DESIG	VXSTD P/N	VERS.	LOT	SIDE	LAY ADR
PCB with Components						CS2079501				
	Printed Circuit Board					FR020650B		1-		
C 6801	CHIP CAP.	0.01uF	50V	B	GRM188B11H103KA01D	K22174823		1-	A	D4
C 6802	CHIP CAP.	0.047uF	50V	F	GRM40F473Z50PT	K22171008		1-	A	B2
C 6803	CHIP CAP.	0.1uF	16V	B	GRM188B11C104KA01D	K22124805		1-	A	D3
C 6804	CHIP CAP.	0.01uF	50V	B	GRM188B11H103KA01D	K22174823		1-	A	D3
C 6805	CHIP CAP.	180pF	50V	CH	GRM1882C1H181JA01D	K22174241		1-	A	C3
C 6806	CHIP CAP.	0.01uF	50V	B	GRM188B11H103KA01D	K22174823		1-	A	D4
C 6807	CHIP CAP.	0.01uF	50V	B	GRM188B11H103KA01D	K22174823		1-	A	B2
C 6808	CHIP CAP.	470pF	50V	CH	GRM1882C1H471JA01D	K22174249		1-	A	C3
C 6809	CHIP CAP.	0.047uF	50V	F	GRM40F473Z50PT	K22171008		1-	A	B3
C 6810	CHIP CAP.	0.01uF	50V	B	GRM188B11H103KA01D	K22174823		1-	A	D4
C 6811	CHIP CAP.	82pF	50V	CH	GRM1882C1H820JA01D	K22174233		1-	A	B3
C 6812	CHIP CAP.	0.01uF	50V	B	GRM188B11H103KA01D	K22174823		1-	A	B3
C 6813	CHIP CAP.	0.047uF	50V	F	GRM40F473Z50PT	K22171008		1-	A	D4
C 6815	CHIP CAP.	0.01uF	50V	B	GRM188B11H103KA01D	K22174823		1-	A	B2
C 6816	CHIP CAP.	0.047uF	50V	F	GRM40F473Z50PT	K22171008		1-	A	D2
C 6817	CHIP CAP.	0.01uF	50V	B	GRM188B11H103KA01D	K22174823		1-	A	D2
C 6818	CHIP CAP.	22pF	50V	CH	GRM1882C1H220JA01D	K22174219		1-	A	C2
C 6819	CHIP CAP.	0.047uF	50V	F	GRM40F473Z50PT	K22171008		1-	A	B2
C 6820	CHIP CAP.	0.047uF	50V	F	GRM40F473Z50PT	K22171008		1-	A	B3
C 6821	CHIP CAP.	0.01uF	50V	B	GRM188B11H103KA01D	K22174823		1-	A	B2
C 6822	CHIP CAP.	0.001uF	50V	B	GRM188B11H102KA01D	K22174821		1-	A	B2
C 6823	CHIP CAP.	0.01uF	50V	B	GRM188B11H103KA01D	K22174823		1-	A	B2
C 6824	CHIP CAP.	0.01uF	50V	B	GRM188B11H103KA01D	K22174823		1-	A	B3
C 6825	CHIP CAP.	0.047uF	50V	F	GRM40F473Z50PT	K22171008		1-	A	B2
C 6826	CHIP CAP.	0.1uF	16V	B	GRM188B11C104KA01D	K22124805		1-	A	B2
C 6827	CHIP CAP.	0.001uF	50V	B	GRM188B11H102KA01D	K22174821		1-	A	B2
C 6828	CHIP CAP.	0.01uF	50V	B	GRM188B11H103KA01D	K22174823		1-	A	B2
C 6829	CHIP CAP.	0.047uF	50V	F	GRM40F473Z50PT	K22171008		1-	A	C2
C 6830	CHIP CAP.	47pF	50V	CH	GRM1882C1H470JA01D	K22174227		1-	A	B2
C 6831	CHIP CAP.	0.01uF	50V	B	GRM188B11H103KA01D	K22174823		1-	A	B2
C 6833	CHIP CAP.	0.1uF	16V	B	GRM188B11C104KA01D	K22124805		1-	A	B2
C 6834	CHIP CAP.	100pF	50V	CH	GRM1882C1H101JA01D	K22174235		1-	A	B3
C 6835	CHIP CAP.	0.01uF	50V	B	GRM188B11H103KA01D	K22174823		1-	A	C2
C 6836	AL.ELECTRO.CAP.	10uF	35V		EEE1VA100WR	K48160006		1-	A	B2
C 6838	CHIP CAP.	100pF	50V	CH	GRM1882C1H101JA01D	K22174235		1-	A	B3
C 6840	CHIP CAP.	0.1uF	16V	B	GRM188B11C104KA01D	K22124805		1-	A	A2
C 6841	CHIP CAP.	47pF	50V	CH	GRM1882C1H470JA01D	K22174227		1-	A	B3
C 6842	CHIP CAP.	0.001uF	50V	B	GRM188B11H102KA01D	K22174821		1-	A	A2
C 6843	CHIP CAP.	0.1uF	16V	B	GRM188B11C104KA01D	K22124805		1-	A	C4
C 6844	CHIP CAP.	6pF	50V	CH	GRM1882C1H6R0DZ01D	K22174207		1-	A	C3
C 6845	CHIP CAP.	4pF	50V	CH	GRM1882C1H4R0CZ01D	K22174205		1-	A	C4
C 6846	CHIP CAP.	5pF	50V	CH	GRM1882C1H5R0CZ01D	K22174206		1-	A	C4
C 6847	CHIP CAP.	22pF	50V	CH	GRM1882C1H220JA01D	K22174219		1-	A	C3
C 6848	CHIP CAP.	0.1uF	16V	B	GRM188B11C104KA01D	K22124805		1-	A	D5
C 6849	CHIP CAP.	0.01uF	50V	B	GRM188B11H103KA01D	K22174823		1-	A	B3
C 6850	CHIP CAP.	0.01uF	50V	B	GRM188B11H103KA01D	K22174823		1-	A	C4
C 6851	CHIP CAP.	0.047uF	50V	F	GRM40F473Z50PT	K22171008		1-	A	B3
C 6852	CHIP CAP.	5pF	50V	CH	GRM1882C1H5R0CZ01D	K22174206		1-	A	B4
C 6853	CHIP CAP.	0.047uF	50V	F	GRM40F473Z50PT	K22171008		1-	A	C4
C 6854	CHIP CAP.	4pF	50V	CH	GRM1882C1H4R0CZ01D	K22174205		1-	A	B4
C 6855	CHIP CAP.	47pF	50V	CH	GRM1882C1H470JA01D	K22174227		1-	A	B4
C 6856	CHIP CAP.	0.01uF	50V	B	GRM188B11H103KA01D	K22174823		1-	A	B3
C 6857	CHIP CAP.	0.01uF	50V	B	GRM188B11H103KA01D	K22174823		1-	A	B5
C 6858	CHIP CAP.	0.047uF	50V	F	GRM40F473Z50PT	K22171008		1-	A	B3
C 6859	CHIP CAP.	3pF	50V	CJ	GRM1883C1H3R0CZ01D	K22174204		1-	A	B4
C 6860	CHIP CAP.	0.047uF	50V	F	GRM40F473Z50PT	K22171008		1-	A	B5
C 6861	CHIP CAP.	7pF	50V	CH	GRM1882C1H7R0DZ01D	K22174208		1-	A	D4
C 6862	CHIP CAP.	100pF	50V	CH	GRM1882C1H101JA01D	K22174235		1-	A	B4
C 6863	CHIP CAP.	0.01uF	50V	B	GRM188B11H103KA01D	K22174823		1-	A	D4
C 6864	CHIP CAP.	0.01uF	50V	B	GRM188B11H103KA01D	K22174823		1-	A	B5
C 6865	CHIP CAP.	5pF	50V	CH	GRM1882C1H5R0CZ01D	K22174206		1-	A	C3
C 6866	CHIP CAP.	0.047uF	50V	F	GRM40F473Z50PT	K22171008		1-	A	D4
C 6867	CHIP CAP.	39pF	50V	CH	GRM1882C1H390JA01D	K22174225		1-	A	B4
C 6868	CHIP CAP.	0.047uF	50V	F	GRM40F473Z50PT	K22171008		1-	A	B5
C 6869	CHIP CAP.	10pF	50V	CH	GRM1882C1H100JA01D	K22174211		1-	A	C3
C 6870	CHIP CAP.	180pF	50V	CH	GRM1882C1H181JA01D	K22174241		1-	A	B4
C 6871	CHIP CAP.	0.1uF	16V	B	GRM188B11C104KA01D	K22124805		1-	A	D5
C 6872	CHIP CAP.	0.01uF	50V	B	GRM188B11H103KA01D	K22174823		1-	A	C4
C 6873	CHIP CAP.	0.01uF	50V	B	GRM188B11H103KA01D	K22174823		1-	A	A5
C 6874	CHIP CAP.	0.047uF	50V	F	GRM40F473Z50PT	K22171008		1-	A	C4
C 6875	CHIP CAP.	0.047uF	50V	F	GRM40F473Z50PT	K22171008		1-	A	B5

VRF-A Unit (VFO-A)

Parts List

REF	DESCRIPTION	VALUE	V/W	TOL.	MFR'S DESIG	VXSTD P/N	VERS.	LOT	SIDE	LAY ADR
C 6876	AL.ELECTRO.CAP.	47uF	16V		EEE1CA470SP	K48120005		1-	A	A2
D 6801	DIODE				BAS316	G2070716		1-	A	B2
D 6802	DIODE				BAS316	G2070716		1-	A	D4
D 6803	DIODE				BAS316	G2070716		1-	A	B3
D 6804	DIODE				BAS316	G2070716		1-	A	B2
D 6805	DIODE				BAS316	G2070716		1-	A	D2
D 6806	DIODE				BAS316	G2070716		1-	A	B2
D 6807	DIODE				BAS316	G2070716		1-	A	B3
D 6808	DIODE				BAS316	G2070716		1-	A	C1
D 6809	DIODE				BAS316	G2070716		1-	A	B3
D 6810	DIODE				BAS316	G2070716		1-	A	C4
D 6811	DIODE				BAS316	G2070716		1-	A	B3
D 6812	DIODE				BAS316	G2070716		1-	A	B5
D 6813	DIODE				BAS316	G2070716		1-	A	D4
D 6814	DIODE				BAS316	G2070716		1-	A	B5
D 6815	DIODE				BAS316	G2070716		1-	A	C4
D 6816	DIODE				BAS316	G2070716		1-	A	A5
FB6801	FERRITE BEADS				BLM18BD182SN1D	L1690602		1-	A	C4
FB6802	FERRITE BEADS				BLM18BD182SN1D	L1690602		1-	A	C4
FB6803	FERRITE BEADS				BLM18BD182SN1D	L1690602		1-	A	C4
J 6804	CONNECTOR				TMP-J01X-V6	P1090210		1-	A	E3
J 6805	CONNECTOR				TMP-J01X-V6	P1090210		1-	A	A3
J 6806	CONNECTOR				18FLT-SM2-TB(LF)(SN)(M)	P1091176		1-	A	C5
L 6801	TOROIDAL COIL	7.65uH			7.65U T80-2	L0022848A		1-	A	C3
L 6802	TOROIDAL COIL	1uH			1.000U T37-6 AMIDON	L0021571		1-	A	D1
L 6803	TOROIDAL COIL	0.42uH			0.420U T37-6 AMIDON	L0021575B		1-	A	C1
L 6804	TOROIDAL COIL	0.185uH			0.185U T37-10	L0022981		1-	A	B1
L 6805	CHIP COIL	0.18uH		2%	C2520C-R18G-RA	L1691297		1-	A	B2
L 6806	CHIP COIL	0.22uH		2%	C2520C-R22G-RA	L1691298		1-	A	B3
L 6807	CHIP COIL	1mH			LQH43MN102K03L	L1690108		1-	A	B2
L 6808	CHIP COIL	0.18uH		2%	C2520C-R18G-RA	L1691297		1-	A	B3
Q 6801	FET				SST310-T1	G4070009		1-	A	B2
Q 6802	TRANSISTOR				UMD5N TR	G3070343		1-	A	C5
Q 6803	IC				NJU3714A(TAPE)	G1094291		1-	A	D5
Q 6804	TRANSISTOR				UMD5N TR	G3070343		1-	A	C5
Q 6805	TRANSISTOR				UMD5N TR	G3070343		1-	A	D5
Q 6806	TRANSISTOR				UMD5N TR	G3070343		1-	A	C4
Q 6807	TRANSISTOR				UMD5N TR	G3070343		1-	A	D4
Q 6808	TRANSISTOR				UMD5N TR	G3070343		1-	A	D4
Q 6809	TRANSISTOR				UMD5N TR	G3070343		1-	A	D4
Q 6810	TRANSISTOR				UMD5N TR	G3070343		1-	A	D4
Q 6811	TRANSISTOR				UMD5N TR	G3070343		1-	A	D4
Q 6812	TRANSISTOR				UMD5N TR	G3070343		1-	A	D5
Q 6813	TRANSISTOR				UMD5N TR	G3070343		1-	A	D4
Q 6814	TRANSISTOR				UMD5N TR	G3070343		1-	A	D5
R 6801	CHIP RES.	100	1/16W	5%	RMC1/16 101JATP	J24185101		1-	A	C2
R 6802	CHIP RES.	100	1/16W	5%	RMC1/16 101JATP	J24185101		1-	A	C2
R 6803	CHIP RES.	100	1/16W	5%	RMC1/16 101JATP	J24185101		1-	A	D4
R 6804	CHIP RES.	100	1/16W	5%	RMC1/16 101JATP	J24185101		1-	A	D2
R 6805	CHIP RES.	100	1/16W	5%	RMC1/16 101JATP	J24185101		1-	A	B2
R 6806	CHIP RES.	100	1/16W	5%	RMC1/16 101JATP	J24185101		1-	A	C2
R 6807	CHIP RES.	1.5k	1/16W	5%	RMC1/16 152JATP	J24185152		1-	A	B2
R 6808	CHIP RES.	10	1/16W	5%	RMC1/16 100JATP	J24185100		1-	A	B2
R 6809	CHIP RES.	100	1/16W	5%	RMC1/16 101JATP	J24185101		1-	A	C2
R 6810	CHIP RES.	100	1/16W	5%	RMC1/16 101JATP	J24185101		1-	A	B2
R 6811	CHIP RES.	100	1/16W	5%	RMC1/16 101JATP	J24185101		1-	A	C2
R 6813	CHIP RES.	10	1/16W	5%	RMC1/16 100JATP	J24185100		1-	A	A2
R 6814	CHIP RES.	100	1/16W	5%	RMC1/16 101JATP	J24185101		1-	A	B3
R 6815	CHIP RES.	100	1/16W	5%	RMC1/16 101JATP	J24185101		1-	A	C4
R 6816	CHIP RES.	470	1/16W	5%	RMC1/16 471JATP	J24185471		1-	A	C4
R 6817	CHIP RES.	470	1/16W	5%	RMC1/16 471JATP	J24185471		1-	A	C4
R 6818	CHIP RES.	470	1/16W	5%	RMC1/16 471JATP	J24185471		1-	A	C4
R 6819	CHIP RES.	100	1/16W	5%	RMC1/16 101JATP	J24185101		1-	A	A4
R 6820	CHIP RES.	100	1/16W	5%	RMC1/16 101JATP	J24185101		1-	A	B5
R 6821	CHIP RES.	100	1/16W	5%	RMC1/16 101JATP	J24185101		1-	A	D4
R 6822	CHIP RES.	100	1/16W	5%	RMC1/16 101JATP	J24185101		1-	A	B5
R 6823	CHIP RES.	100	1/16W	5%	RMC1/16 101JATP	J24185101		1-	A	C4
R 6824	CHIP RES.	100	1/16W	5%	RMC1/16 101JATP	J24185101		1-	A	B5
RL6801	RELAY		DC12V		G6K-2F-Y-TR DC12V	M1190183		1-	A	D4
RL6802	RELAY		DC12V		G6K-2F-Y-TR DC12V	M1190183		1-	A	B2
RL6803	RELAY		DC12V		G6K-2F-Y-TR DC12V	M1190183		1-	A	B3
RL6804	RELAY		DC12V		G6K-2F-Y-TR DC12V	M1190183		1-	A	B2
RL6805	RELAY		DC12V		G6K-2F-Y-TR DC12V	M1190183		1-	A	D2

VRF-A Unit (VFO-A)

Parts List

REF	DESCRIPTION	VALUE	V/W	TOL.	MFR'S DESIG	VXSTD P/N	VERS.	LOT	SIDE	LAY ADR
RL6806	RELAY		DC12V		G6K-2F-Y-TR DC12V	M1190183		1-	A	C2
RL6807	RELAY		DC12V		G6K-2F-Y-TR DC12V	M1190183		1-	A	C3
RL6808	RELAY		DC12V		G6K-2F-Y-TR DC12V	M1190183		1-	A	C2
RL6809	RELAY		DC12V		G6K-2F-Y-TR DC12V	M1190183		1-	A	B4
RL6810	RELAY		DC12V		G6K-2F-Y-TR DC12V	M1190183		1-	A	C4
RL6811	RELAY		DC12V		G6K-2F-Y-TR DC12V	M1190183		1-	A	B4
RL6812	RELAY		DC12V		G6K-2F-Y-TR DC12V	M1190183		1-	A	B4
RL6813	RELAY		DC12V		G6K-2F-Y-TR DC12V	M1190183		1-	A	D4
RL6814	RELAY		DC12V		G6K-2F-Y-TR DC12V	M1190183		1-	A	B4
RL6815	RELAY		DC12V		G6K-2F-Y-TR DC12V	M1190183		1-	A	C4
RL6816	RELAY		DC12V		G6K-2F-Y-TR DC12V	M1190183		1-	A	A4
	SHIELD CASE COVER				(VRFA)	RA1170300		1-		

VRF-A Unit (VFO-A)

Note:

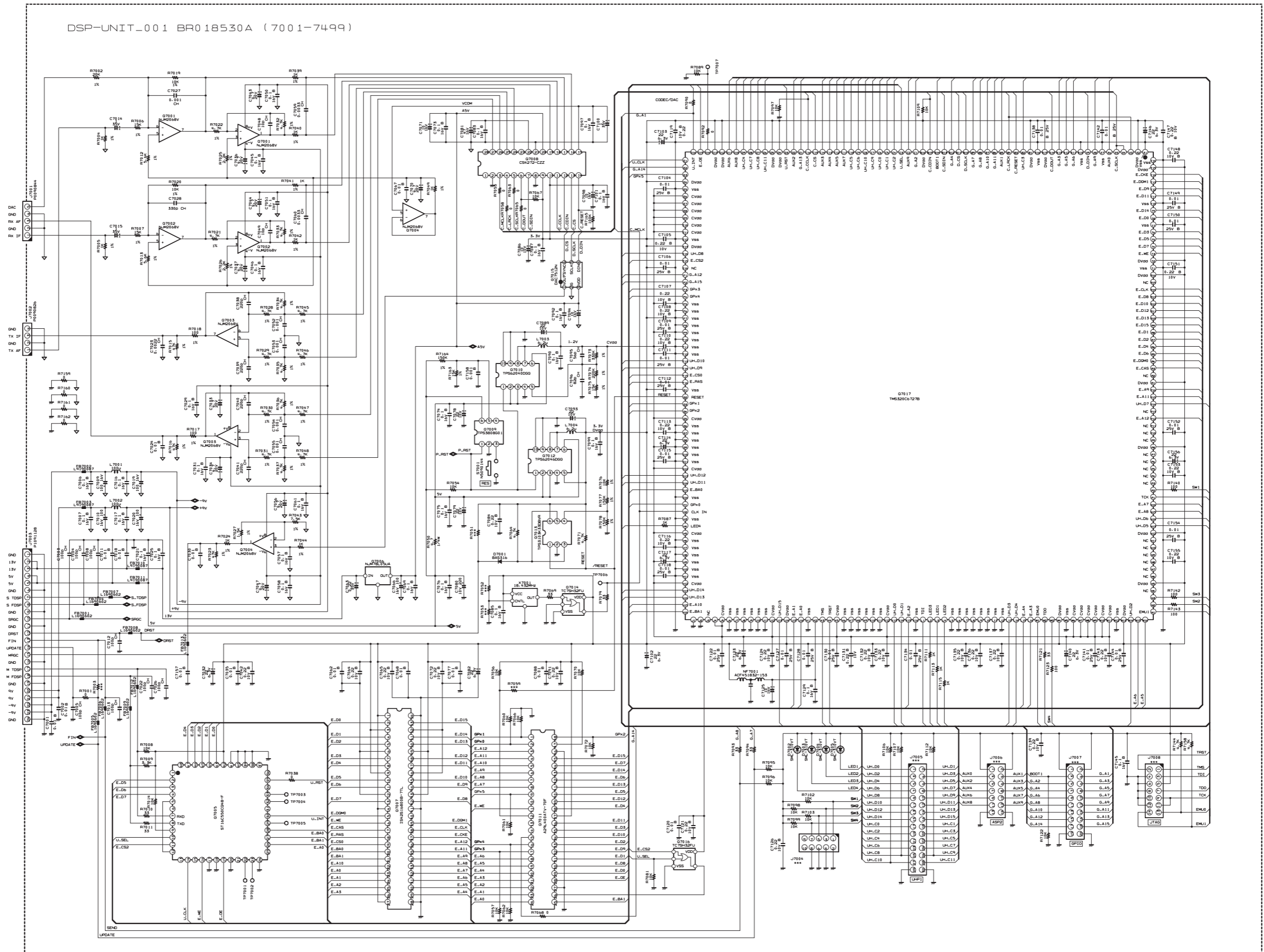

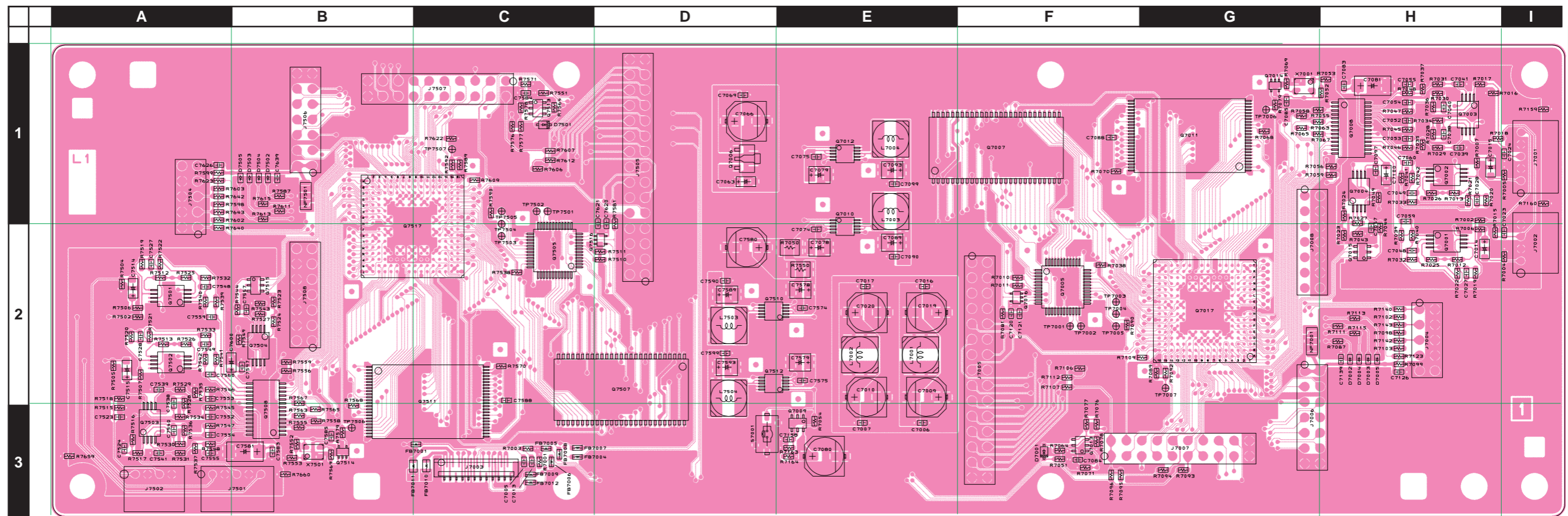

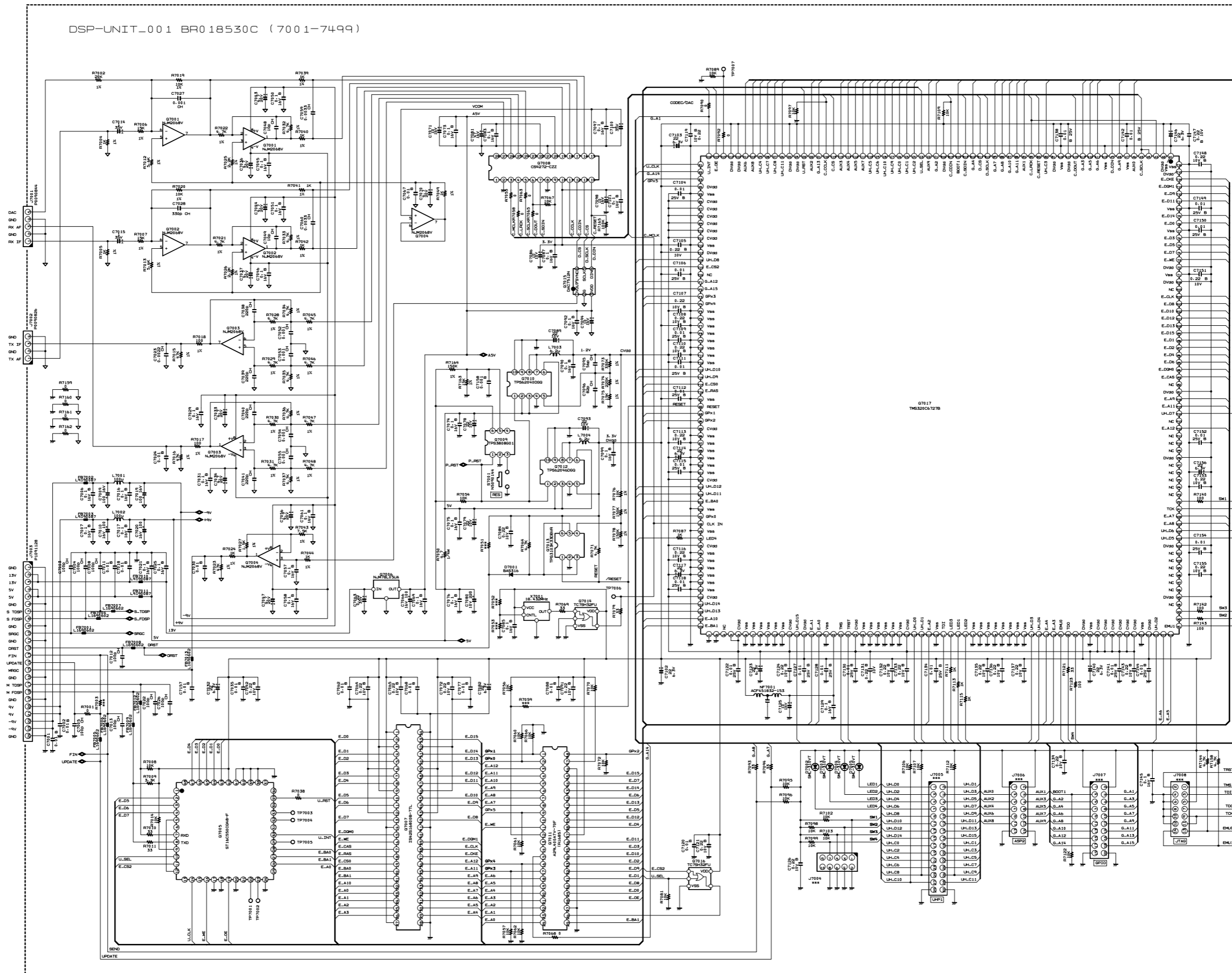

DSP Unit (Lot. 5 ~)

Circuit Diagram (2)

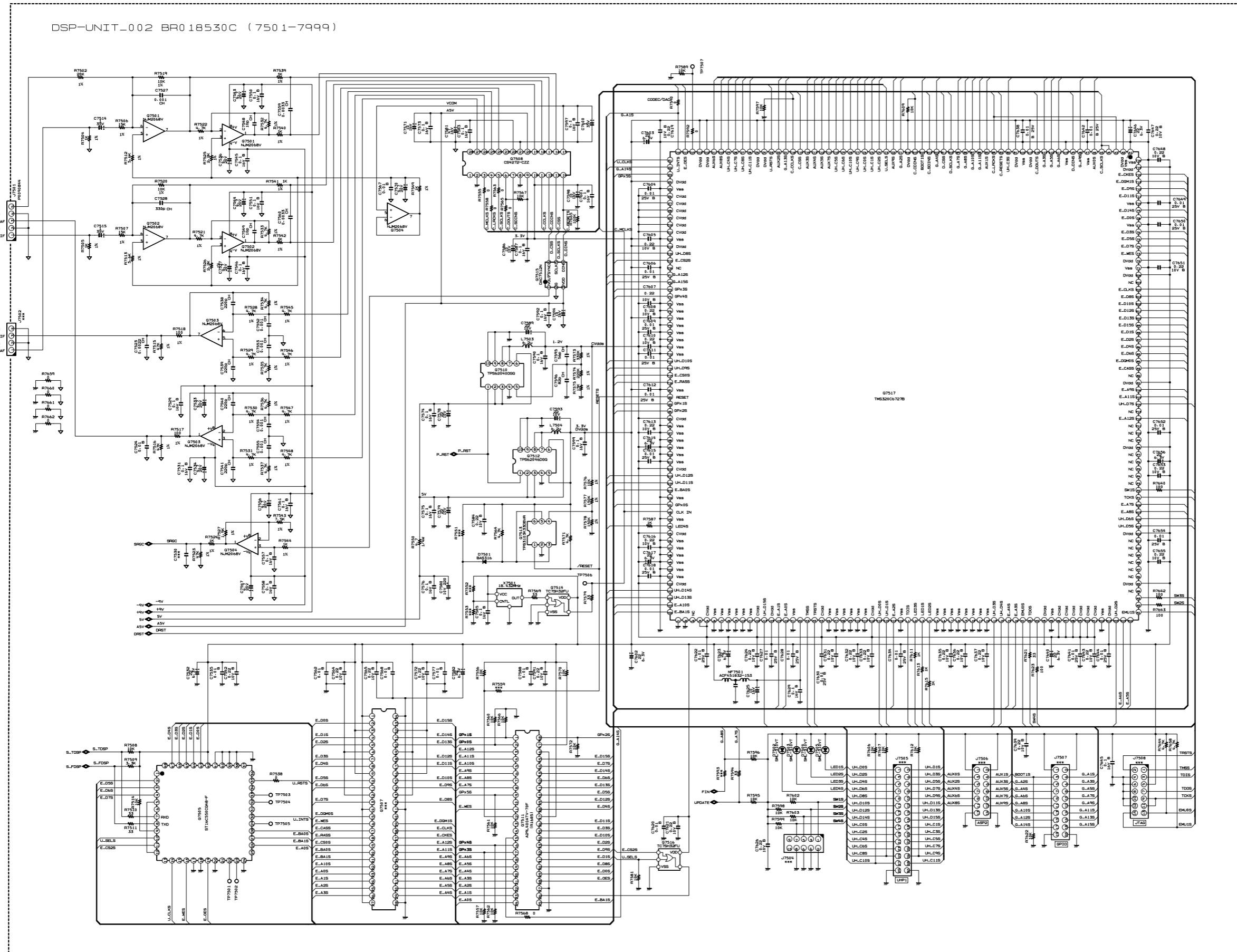

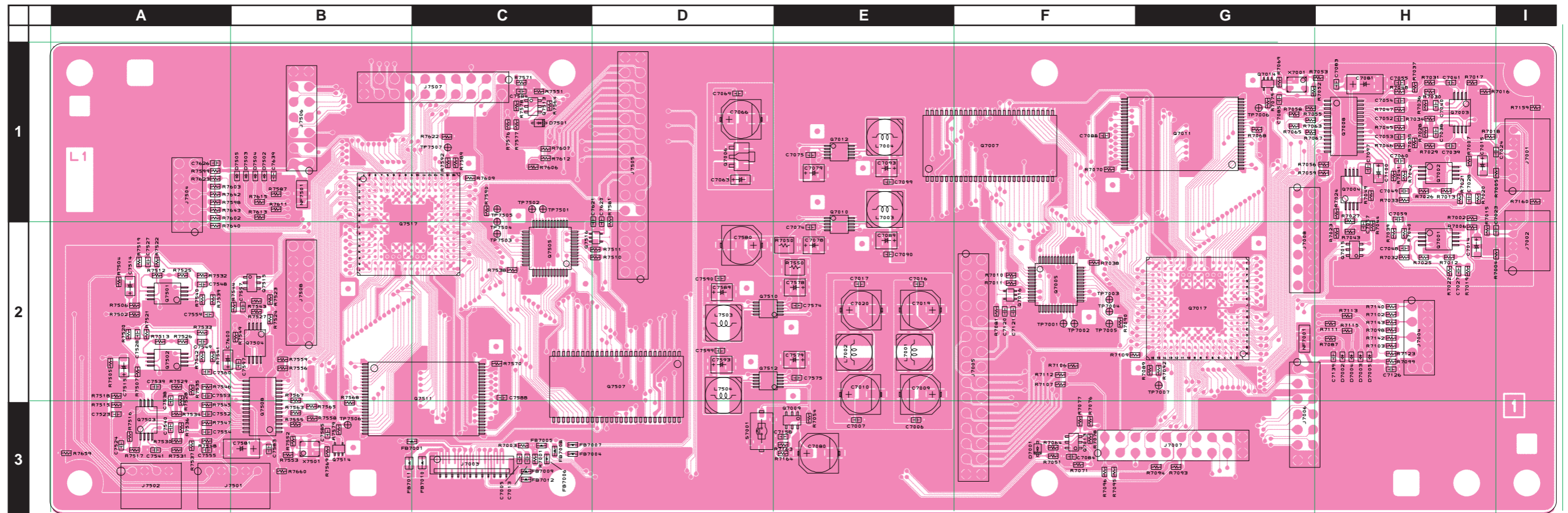

DSP Unit (Lot. 5 ~)

Parts Layout (Side B)

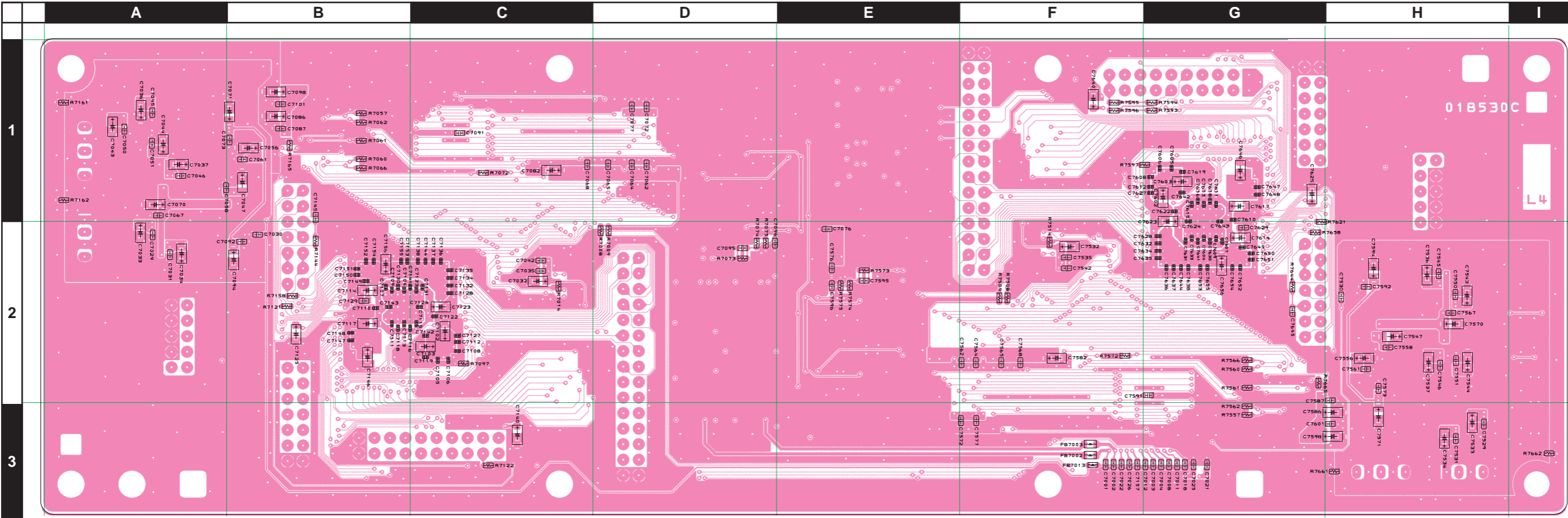

REF	DESCRIPTION	VALUE	V/W	TOL.	MFR'S DESIG	VXSTD P/N	VERS.	LOT	SIDE	LAY ADR
	PCB with Components					CS2070501				
	Printed Circuit Board					FR018530B		1-		
	Printed Circuit Board					FR018530C		5-		
C 7001	CHIP CAP.	0.01uF	50V	B	GRM188B11H103KA01D	K22174823		1-	B	f3
C 7002	CHIP CAP.	0.01uF	50V	B	GRM188B11H103KA01D	K22174823		1-	B	f3
C 7003	CHIP CAP.	100pF	50V	CH	GRM1882C1H101JA01D	K22174235		1-	B	g3
C 7004	CHIP CAP.	100pF	50V	CH	GRM1882C1H101JA01D	K22174235		1-	B	g3
C 7005	CHIP CAP.	100pF	50V	CH	GRM1882C1H101JA01D	K22174235		1-	A	C3
C 7006	CHIP CAP.	0.1uF	16V	B	GRM188B11C104KA01D	K22124805		1-	A	E3
C 7007	CHIP CAP.	0.1uF	16V	B	GRM188B11C104KA01D	K22124805		1-	A	E3
C 7008	CHIP CAP.	100pF	50V	CH	GRM1882C1H101JA01D	K22174235		1-	B	g3
C 7009	AL.ELECTRO.CAP.	100uF	16V		EEE1CA101WP	K48120012		1-	A	E2
C 7010	AL.ELECTRO.CAP.	100uF	16V		EEE1CA101WP	K48120012		1-	A	E2
C 7011	CHIP CAP.	0.01uF	50V	B	GRM188B11H103KA01D	K22174823		1-	B	g3
C 7012	CHIP CAP.	100pF	50V	CH	GRM1882C1H101JA01D	K22174235		1-	B	g3
C 7013	CHIP CAP.	100pF	50V	CH	GRM1882C1H101JA01D	K22174235		1-	A	C3
C 7014	CHIP TA.CAP.	1uF	35V		TEESVA1V105M8R	K78160032		1-	A	H2
C 7015	CHIP TA.CAP.	1uF	35V		TEESVA1V105M8R	K78160032		1-	A	H1
C 7016	CHIP CAP.	0.1uF	16V	B	GRM188B11C104KA01D	K22124805		1-	A	E2
C 7017	CHIP CAP.	0.1uF	16V	B	GRM188B11C104KA01D	K22124805		1-	A	E2
C 7018	CHIP CAP.	0.01uF	50V	B	GRM188B11H103KA01D	K22174823		1-	B	g3
C 7019	AL.ELECTRO.CAP.	100uF	16V		EEE1CA101WP	K48120012		1-	A	E2
C 7020	AL.ELECTRO.CAP.	100uF	16V		EEE1CA101WP	K48120012		1-	A	E2
C 7021	CHIP CAP.	0.1uF	16V	B	GRM188B11C104KA01D	K22124805		1-	B	g3
C 7022	CHIP CAP.	100pF	50V	CH	GRM1882C1H101JA01D	K22174235		1-	B	f3
C 7023	CHIP CAP.	0.0022uF	50V	CH	GRM1882C1H222JA01D	K22174279		1-	A	l2
C 7024	CHIP CAP.	0.01uF	50V	B	GRM188B11H103KA01D	K22174823		1-	A	l1
C 7025	CHIP CAP.	0.1uF	16V	B	GRM188B11C104KA01D	K22124805		1-	B	g3
C 7026	CHIP CAP.	100pF	50V	CH	GRM1882C1H101JA01D	K22174235		1-	B	f3
C 7027	CHIP CAP.	0.001uF	50V	CH	GRM1882C1H102JA01D	K22174275		1-	A	H2
C 7028	CHIP CAP.	330pF	50V	CH	GRM1882C1H331JA01D	K22174253		1-	A	H1
C 7029	CHIP CAP.	0.1uF	16V	B	GRM188B11C104KA01D	K22124805		1-	B	a2
C 7030	CHIP CAP.	0.01uF	50V	B	GRM188B11H103KA01D	K22174823		1-	B	b2
C 7031	CHIP CAP.	0.1uF	16V	B	GRM188B11C104KA01D	K22124805		1-	B	a2
C 7032	CHIP TA.CAP.	22uF	6.3V		TEESVA0J226M8R	K78080047		1-	B	c2
C 7033	CHIP TA.CAP.	4.7uF	20V		TEESVA1D475M8R	K78130048		1-	B	a2
C 7034	CHIP TA.CAP.	4.7uF	20V		TEESVA1D475M8R	K78130048		1-	B	a2
C 7035	CHIP CAP.	0.01uF	50V	B	GRM188B11H103KA01D	K22174823		1-	B	c2
C 7036	CHIP TA.CAP.	4.7uF	20V		TEESVA1D475M8R	K78130048		1-	B	a1
C 7037	CHIP TA.CAP.	4.7uF	20V		TEESVA1D475M8R	K78130048		1-	B	a1
C 7038	CHIP CAP.	220pF	50V	CH	GRM1882C1H221JA01D	K22174243		1-	A	H1
C 7039	CHIP CAP.	220pF	50V	CH	GRM1882C1H221JA01D	K22174243		1-	A	H1
C 7040	CHIP CAP.	220pF	50V	CH	GRM1882C1H221JA01D	K22174243		1-	A	H1
C 7041	CHIP CAP.	220pF	50V	CH	GRM1882C1H221JA01D	K22174243		1-	A	H1
C 7042	CHIP CAP.	0.22uF	10V	B	GRM188B11A224KA01D	K22104801		1-	B	c2
C 7043	CHIP TA.CAP.	4.7uF	20V		TEESVA1D475M8R	K78130048		1-	B	a1
C 7044	CHIP TA.CAP.	4.7uF	20V		TEESVA1D475M8R	K78130048		1-	B	a1
C 7045	CHIP CAP.	0.1uF	16V	B	GRM188B11C104KA01D	K22124805		1-	B	a1
C 7046	CHIP CAP.	0.1uF	16V	B	GRM188B11C104KA01D	K22124805		1-	B	a1
C 7047	CHIP TA.CAP.	4.7uF	20V		TEESVA1D475M8R	K78130048		1-	B	b1
C 7048	CHIP CAP.	10pF	50V	CH	GRM1882C1H100JA01D	K22174211		1-	A	H2
C 7049	CHIP CAP.	10pF	50V	CH	GRM1882C1H100JA01D	K22174211		1-	A	H1
C 7050	CHIP CAP.	0.1uF	16V	B	GRM188B11C104KA01D	K22124805		1-	B	a1
C 7051	CHIP CAP.	0.1uF	16V	B	GRM188B11C104KA01D	K22124805		1-	B	a1
C 7052	CHIP CAP.	0.001uF	50V	CH	GRM1882C1H102JA01D	K22174275		1-	A	H1
C 7053	CHIP CAP.	0.001uF	50V	CH	GRM1882C1H102JA01D	K22174275		1-	A	H1
C 7054	CHIP CAP.	0.001uF	50V	CH	GRM1882C1H102JA01D	K22174275		1-	A	H1
C 7055	CHIP CAP.	0.001uF	50V	CH	GRM1882C1H102JA01D	K22174275		1-	A	H1
C 7056	CHIP TA.CAP.	4.7uF	20V		TEESVA1D475M8R	K78130048		1-	B	b1
C 7057	CHIP CAP.	0.1uF	16V	B	GRM188B11C104KA01D	K22124805		1-	A	H2
C 7058	CHIP CAP.	0.1uF	16V	B	GRM188B11C104KA01D	K22124805		1-	B	b1
C 7059	CHIP CAP.	0.0033uF	50V	CH	GRM1882C1H332JA01D	K22174281		1-	A	H1
C 7060	CHIP CAP.	0.0033uF	50V	CH	GRM1882C1H332JA01D	K22174281		1-	A	H1
C 7061	CHIP CAP.	0.1uF	16V	B	GRM188B11C104KA01D	K22124805		1-	B	b1
C 7062	CHIP CAP.	0.01uF	50V	B	GRM188B11H103KA01D	K22174823		1-	B	d1
C 7063	CHIP TA.CAP.	0.22uF	35V		TEESVA1V224M8R	K78160027		1-	A	D1
C 7064	CHIP CAP.	0.22uF	10V	B	GRM188B11A224KA01D	K22104801		1-	B	d1
C 7065	CHIP CAP.	0.22uF	10V	B	GRM188B11A224KA01D	K22104801		1-	B	d1
C 7066	AL.ELECTRO.CAP.	100uF	16V		EEE1CA101WP	K48120012		1-	A	D1
C 7067	CHIP CAP.	0.01uF	50V	B	GRM188B11H103KA01D	K22174823		1-	B	a1
C 7068	CHIP CAP.	0.01uF	50V	B	GRM188B11H103KA01D	K22174823		1-	B	c1
C 7069	CHIP CAP.	0.1uF	16V	B	GRM188B11C104KA01D	K22124805		1-	A	D1
C 7070	CHIP TA.CAP.	4.7uF	20V		TEESVA1D475M8R	K78130048		1-	B	a1

DSP Unit

Parts List

REF	DESCRIPTION	VALUE	V/W	TOL.	MFR'S DESIG	VXSTD P/N	VERS.	LOT	SIDE	LAY ADR
C 7071	CHIP TA.CAP.	10uF	16V		TEESVA1C106M8R	K78120077		1-	B	b1
C 7072	CHIP CAP.	0.22uF	10V	B	GRM188B11A224KA01D	K22104801		1-	B	d1
C 7073	CHIP CAP.	0.1uF	16V	B	GRM188B11C104KA01D	K22124805		1-	B	b1
C 7074	CHIP CAP.	0.1uF	16V	B	GRM188B11C104KA01D	K22124805		1-	A	E2
C 7075	CHIP CAP.	0.1uF	16V	B	GRM188B11C104KA01D	K22124805		1-	A	E1
C 7076	CHIP CAP.	0.1uF	16V	B	GRM188B11C104KA01D	K22124805		1-	B	e2
C 7077	CHIP CAP.	0.01uF	50V	B	GRM188B11H103KA01D	K22174823		1-	B	d1
C 7078	CHIP TA.CAP.	22uF	10V		TEESVB21A226M8R	K78100029		1-	A	E2
C 7079	CHIP TA.CAP.	22uF	10V		TEESVB21A226M8R	K78100029		1-	A	E1
C 7080	AL.ELECTRO.CAP.	220uF	10V		EEE1AA221XP	K48100007		1-	A	E3
C 7081	CHIP TA.CAP.	47uF	16V		TEESVC1C476M12R	K78120057		1-	A	H1
C 7082	CHIP TA.CAP.	22uF	6.3V		TEESVAOJ226M8R	K78080047		1-	B	c1
C 7083	CHIP CAP.	0.1uF	16V	B	GRM188B11C104KA01D	K22124805		1-	A	H1
C 7084	CHIP CAP.	0.22uF	10V	B	GRM188B11A224KA01D	K22104801		1-	A	F3
C 7085	CHIP CAP.	0.1uF	16V	B	GRM188B11C104KA01D	K22124805		1-	A	G1
C 7086	CHIP TA.CAP.	10uF	10V		TAJA106M010Y	K78100072		1-	B	b1
C 7087	CHIP CAP.	0.1uF	16V	B	GRM188B11C104KA01D	K22124805		1-	B	b1
C 7088	CHIP CAP.	0.01uF	50V	B	GRM188B11H103KA01D	K22174823		1-	A	F1
C 7089	CHIP TA.CAP.	22uF	10V		TEESVB21A226M8R	K78100029		1-	A	E2
C 7090	CHIP CAP.	0.1uF	16V	B	GRM188B11C104KA01D	K22124805		1-	A	E2
C 7091	CHIP CAP.	0.22uF	10V	B	GRM188B11A224KA01D	K22104801		1-	B	c1
C 7092	CHIP CAP.	0.1uF	16V	B	GRM188B11C104KA01D	K22124805		1-	B	b2
C 7093	CHIP TA.CAP.	22uF	10V		TEESVB21A226M8R	K78100029		1-	A	E1
C 7094	CHIP TA.CAP.	10uF	16V		TEESVA1C106M8R	K78120077		1-	B	b2
C 7095	CHIP CAP.	56pF	50V	CH	GRM1882C1H560JA01D	K22174229		1-	B	d2
C 7096	CHIP CAP.	82pF	50V	CH	GRM1882C1H820JA01D	K22174233		1-	B	e2
C 7097	CHIP CAP.	0.1uF	16V	B	GRM188B11C104KA01D	K22124805		1-	A	H1
C 7098	CHIP TA.CAP.	10uF	16V		TEESVA1C106M8R	K78120077		1-	B	b1
C 7099	CHIP CAP.	0.1uF	16V	B	GRM188B11C104KA01D	K22124805		1-	A	E1
C 7100	CHIP TA.CAP.	1uF	35V		TEESVA1V105M8R	K78160032		1-	A	H1
C 7101	CHIP CAP.	0.1uF	16V	B	GRM188B11C104KA01D	K22124805		1-	B	b1
C 7102	CHIP TA.CAP.	22uF	6.3V		TEESVAOJ226M8R	K78080047		1-	B	c2
C 7103	CHIP TA.CAP.	22uF	6.3V		TEESVAOJ226M8R	K78080047		1-	B	c2
C 7104	CHIP CAP.	0.01uF	25V	B	GRM155B11E103KA01D	K22148834		1-	B	b2
C 7105	CHIP CAP.	0.22uF	10V	B	GRM155B31A224KE18D	K22108808		1-	B	c2
C 7106	CHIP CAP.	0.01uF	25V	B	GRM155B11E103KA01D	K22148834		1-	B	c2
C 7107	CHIP CAP.	0.22uF	10V	B	GRM155B31A224KE18D	K22108808		1-	B	b2
C 7108	CHIP CAP.	0.22uF	10V	B	GRM155B31A224KE18D	K22108808		1-	B	c2
C 7109	CHIP CAP.	0.01uF	25V	B	GRM155B11E103KA01D	K22148834		1-	B	b2
C 7110	CHIP CAP.	0.22uF	10V	B	GRM155B31A224KE18D	K22108808		1-	B	b2
C 7111	CHIP CAP.	0.01uF	25V	B	GRM155B11E103KA01D	K22148834		1-	B	b2
C 7112	CHIP CAP.	0.01uF	25V	B	GRM155B11E103KA01D	K22148834		1-	B	c2
C 7113	CHIP CAP.	0.22uF	10V	B	GRM155B31A224KE18D	K22108808		1-	B	b2
C 7114	CHIP TA.CAP.	22uF	6.3V		TEESVAOJ226M8R	K78080047		1-	B	b2
C 7115	CHIP CAP.	0.01uF	25V	B	GRM155B11E103KA01D	K22148834		1-	B	c2
C 7116	CHIP CAP.	0.22uF	10V	B	GRM155B31A224KE18D	K22108808		1-	B	c2
C 7117	CHIP TA.CAP.	22uF	6.3V		TEESVAOJ226M8R	K78080047		1-	B	b2
C 7118	CHIP CAP.	0.01uF	25V	B	GRM155B11E103KA01D	K22148834		1-	B	b2
C 7119	CHIP CAP.	0.22uF	10V	B	GRM155B31A224KE18D	K22108808		1-	B	c2
C 7120	CHIP CAP.	0.01uF	50V	B	GRM188B11H103KA01D	K22174823		1-	A	F2
C 7121	CHIP CAP.	0.22uF	10V	B	GRM188B11A224KA01D	K22104801		1-	A	F2
C 7122	CHIP CAP.	0.01uF	25V	B	GRM155B11E103KA01D	K22148834		1-	B	c2
C 7123	CHIP TA.CAP.	22uF	6.3V		TEESVAOJ226M8R	K78080047		1-	B	c2
C 7124	CHIP CAP.	0.22uF	10V	B	GRM155B31A224KE18D	K22108808		1-	B	c2
C 7125	CHIP TA.CAP.	10uF	16V		TEESVA1C106M8R	K78120077		1-	B	b2
C 7126	CHIP CAP.	0.22uF	10V	B	GRM188B11A224KA01D	K22104801		1-	A	H2
C 7127	CHIP CAP.	0.01uF	25V	B	GRM155B11E103KA01D	K22148834		1-	B	c2
C 7128	CHIP CAP.	0.01uF	25V	B	GRM155B11E103KA01D	K22148834		1-	B	c2
C 7129	CHIP CAP.	0.1uF	16V	B	GRM188B11C104KA01D	K22124805		1-	B	b2
C 7130	CHIP CAP.	0.01uF	25V	B	GRM155B11E103KA01D	K22148834		1-	B	b2
C 7131	CHIP CAP.	0.22uF	10V	B	GRM155B31A224KE18D	K22108808		1-	B	c2
C 7132	CHIP CAP.	0.22uF	10V	B	GRM155B31A224KE18D	K22108808		1-	B	c2
C 7133	CHIP CAP.	0.22uF	10V	B	GRM155B31A224KE18D	K22108808		1-	B	c2
C 7134	CHIP CAP.	0.01uF	25V	B	GRM155B11E103KA01D	K22148834		1-	B	c2
C 7135	CHIP CAP.	0.22uF	10V	B	GRM155B31A224KE18D	K22108808		1-	B	c2
C 7136	CHIP CAP.	0.22uF	10V	B	GRM155B31A224KE18D	K22108808		1-	B	c2
C 7137	CHIP CAP.	0.22uF	10V	B	GRM155B31A224KE18D	K22108808		1-	B	c2
C 7138	CHIP CAP.	0.01uF	25V	B	GRM155B11E103KA01D	K22148834		1-	B	c2
C 7139	CHIP CAP.	0.22uF	10V	B	GRM188B11A224KA01D	K22104801		1-	A	H2
C 7140	CHIP TA.CAP.	22uF	6.3V		TEESVAOJ226M8R	K78080047		1-	B	c3
C 7141	CHIP CAP.	0.01uF	25V	B	GRM155B11E103KA01D	K22148834		1-	B	c2
C 7142	CHIP CAP.	0.01uF	25V	B	GRM155B11E103KA01D	K22148834		1-	B	c2
C 7143	CHIP CAP.	0.22uF	10V	B	GRM155B31A224KE18D	K22108808		1-	B	b2

REF	DESCRIPTION	VALUE	V/W	TOL.	MFR'S DESIG	VXSTD P/N	VERS.	LOT	SIDE	LAY ADR
C 7144	CHIP CAP.	0.01uF	25V	B	GRM155B11E103KA01D	K22148834		1-	B	c2
C 7145	CHIP CAP.	0.1uF	16V	B	GRM188B11C104KA01D	K22124805		1-	B	b1
C 7146	CHIP TA.CAP.	22uF	6.3V		TEESVA0J226M8R	K78080047		1-	B	b2
C 7147	CHIP CAP.	0.22uF	10V	B	GRM155B31A224KE18D	K22108808		1-	B	b2
C 7148	CHIP CAP.	0.22uF	10V	B	GRM155B31A224KE18D	K22108808		1-	B	b2
C 7149	CHIP CAP.	0.01uF	25V	B	GRM155B11E103KA01D	K22148834		1-	B	b2
C 7150	CHIP CAP.	0.01uF	25V	B	GRM155B11E103KA01D	K22148834		1-	B	b2
C 7151	CHIP CAP.	0.22uF	10V	B	GRM155B31A224KE18D	K22108808		1-	B	b2
C 7152	CHIP CAP.	0.01uF	25V	B	GRM155B11E103KA01D	K22148834		1-	B	b2
C 7153	CHIP CAP.	0.22uF	10V	B	GRM155B31A224KE18D	K22108808		1-	B	c2
C 7154	CHIP CAP.	0.01uF	25V	B	GRM155B11E103KA01D	K22148834		1-	B	b2
C 7155	CHIP CAP.	0.22uF	10V	B	GRM155B31A224KE18D	K22108808		1-	B	b2
C 7156	CHIP TA.CAP.	22uF	6.3V		TEESVA0J226M8R	K78080047		1-	B	b2
C 7157	CHIP CAP.	0.01uF	50V	B	GRM188B11H103KA01D	K22174823		1-	B	f3
C 7158	CHIP CAP.	0.001uF	50V	B	GRM188B11H102KA01D	K22174821		1-	A	E3
C 7514	CHIP TA.CAP.	1uF	35V		TEESVA1V105M8R	K78160032		1-	A	A2
C 7515	CHIP TA.CAP.	1uF	35V		TEESVA1V105M8R	K78160032		1-	A	A2
C 7523	CHIP CAP.	0.0022uF	50V	CH	GRM1882C1H222JA01D	K22174279		1-	A	A3
C 7524	CHIP CAP.	0.01uF	50V	B	GRM188B11H103KA01D	K22174823		1-	A	A3
C 7527	CHIP CAP.	0.001uF	50V	CH	GRM1882C1H102JA01D	K22174275		1-	A	A2
C 7528	CHIP CAP.	330pF	50V	CH	GRM1882C1H331JA01D	K22174253		1-	A	A2
C 7529	CHIP CAP.	0.1uF	16V	B	GRM188B11C104KA01D	K22124805		1-	B	h3
C 7531	CHIP CAP.	0.1uF	16V	B	GRM188B11C104KA01D	K22124805		1-	B	h3
C 7532	CHIP TA.CAP.	22uF	6.3V		TEESVA0J226M8R	K78080047		1-	B	f2
C 7533	CHIP TA.CAP.	4.7uF	20V		TEESVA1D475M8R	K78130048		1-	B	h3
C 7534	CHIP TA.CAP.	4.7uF	20V		TEESVA1D475M8R	K78130048		1-	B	h3
C 7535	CHIP CAP.	0.01uF	50V	B	GRM188B11H103KA01D	K22174823		1-	B	f2
C 7536	CHIP TA.CAP.	4.7uF	20V		TEESVA1D475M8R	K78130048		1-	B	h2
C 7537	CHIP TA.CAP.	4.7uF	20V		TEESVA1D475M8R	K78130048		1-	B	h2
C 7538	CHIP CAP.	220pF	50V	CH	GRM1882C1H221JA01D	K22174243		1-	A	A2
C 7539	CHIP CAP.	220pF	50V	CH	GRM1882C1H221JA01D	K22174243		1-	A	A2
C 7540	CHIP CAP.	220pF	50V	CH	GRM1882C1H221JA01D	K22174243		1-	A	A3
C 7541	CHIP CAP.	220pF	50V	CH	GRM1882C1H221JA01D	K22174243		1-	A	A3
C 7542	CHIP CAP.	0.22uF	10V	B	GRM188B11A224KA01D	K22104801		1-	B	f2
C 7543	CHIP TA.CAP.	4.7uF	20V		TEESVA1D475M8R	K78130048		1-	B	h2
C 7544	CHIP TA.CAP.	4.7uF	20V		TEESVA1D475M8R	K78130048		1-	B	h2
C 7545	CHIP CAP.	0.1uF	16V	B	GRM188B11C104KA01D	K22124805		1-	B	h2
C 7546	CHIP CAP.	0.1uF	16V	B	GRM188B11C104KA01D	K22124805		1-	B	h2
C 7547	CHIP TA.CAP.	4.7uF	20V		TEESVA1D475M8R	K78130048		1-	B	h2
C 7548	CHIP CAP.	10pF	50V	CH	GRM1882C1H100JA01D	K22174211		1-	A	A2
C 7549	CHIP CAP.	10pF	50V	CH	GRM1882C1H100JA01D	K22174211		1-	A	A2
C 7550	CHIP CAP.	0.1uF	16V	B	GRM188B11C104KA01D	K22124805		1-	B	h2
C 7551	CHIP CAP.	0.1uF	16V	B	GRM188B11C104KA01D	K22124805		1-	B	h2
C 7552	CHIP CAP.	0.001uF	50V	CH	GRM1882C1H102JA01D	K22174275		1-	A	A3
C 7553	CHIP CAP.	0.001uF	50V	CH	GRM1882C1H102JA01D	K22174275		1-	A	A2
C 7554	CHIP CAP.	0.001uF	50V	CH	GRM1882C1H102JA01D	K22174275		1-	A	A3
C 7555	CHIP CAP.	0.001uF	50V	CH	GRM1882C1H102JA01D	K22174275		1-	A	A3
C 7556	CHIP TA.CAP.	4.7uF	20V		TEESVA1D475M8R	K78130048		1-	B	h2
C 7557	CHIP CAP.	0.1uF	16V	B	GRM188B11C104KA01D	K22124805		1-	A	B2
C 7558	CHIP CAP.	0.1uF	16V	B	GRM188B11C104KA01D	K22124805		1-	B	h2
C 7559	CHIP CAP.	0.0033uF	50V	CH	GRM1882C1H332JA01D	K22174281		1-	A	A2
C 7560	CHIP CAP.	0.0033uF	50V	CH	GRM1882C1H332JA01D	K22174281		1-	A	A2
C 7561	CHIP CAP.	0.1uF	16V	B	GRM188B11C104KA01D	K22124805		1-	B	h2
C 7562	CHIP CAP.	0.01uF	50V	B	GRM188B11H103KA01D	K22174823		1-	B	f2
C 7564	CHIP CAP.	0.22uF	10V	B	GRM188B11A224KA01D	K22104801		1-	B	f2
C 7565	CHIP CAP.	0.22uF	10V	B	GRM188B11A224KA01D	K22104801		1-	B	f2
C 7567	CHIP CAP.	0.01uF	50V	B	GRM188B11H103KA01D	K22174823		1-	B	h2
C 7568	CHIP CAP.	0.01uF	50V	B	GRM188B11H103KA01D	K22174823		1-	B	f2
C 7570	CHIP TA.CAP.	4.7uF	20V		TEESVA1D475M8R	K78130048		1-	B	h2
C 7571	CHIP TA.CAP.	10uF	16V		TEESVA1C106M8R	K78120077		1-	B	h3
C 7572	CHIP CAP.	0.22uF	10V	B	GRM188B11A224KA01D	K22104801		1-	B	f3
C 7573	CHIP CAP.	0.1uF	16V	B	GRM188B11C104KA01D	K22124805		1-	B	h2
C 7574	CHIP CAP.	0.1uF	16V	B	GRM188B11C104KA01D	K22124805		1-	A	E2
C 7575	CHIP CAP.	0.1uF	16V	B	GRM188B11C104KA01D	K22124805		1-	A	E2
C 7576	CHIP CAP.	0.1uF	16V	B	GRM188B11C104KA01D	K22124805		1-	B	e2
C 7577	CHIP CAP.	0.01uF	50V	B	GRM188B11H103KA01D	K22174823		1-	B	f3
C 7578	CHIP TA.CAP.	22uF	10V		TEESVB21A226M8R	K78100029		1-	A	E2
C 7579	CHIP TA.CAP.	22uF	10V		TEESVB21A226M8R	K78100029		1-	A	E2
C 7580	AL.ELECTRO.CAP.	220uF	10V		EEE1AA221XP	K48100007		1-	A	D2
C 7581	CHIP TA.CAP.	47uF	16V		TEESVC1C476M12R	K78120057		1-	A	B3
C 7582	CHIP TA.CAP.	22uF	6.3V		TEESVA0J226M8R	K78080047		1-	B	f2
C 7583	CHIP CAP.	0.1uF	16V	B	GRM188B11C104KA01D	K22124805		1-	A	B3
C 7584	CHIP CAP.	0.22uF	10V	B	GRM188B11A224KA01D	K22104801		1-	A	C1

DSP Unit

Parts List

REF	DESCRIPTION	VALUE	V/W	TOL.	MFR'S DESIG	VXSTD P/N	VERS.	LOT	SIDE	LAY ADR
C 7585	CHIP CAP.	0.1uF	16V	B	GRM188B11C104KA01D	K22124805		1-	A	B3
C 7586	CHIP TA.CAP.	10uF	10V		TAJA106M010Y	K78100072		1-	B	h3
C 7587	CHIP CAP.	0.1uF	16V	B	GRM188B11C104KA01D	K22124805		1-	B	h2
C 7588	CHIP CAP.	0.01uF	50V	B	GRM188B11H103KA01D	K22174823		1-	A	C2
C 7589	CHIP TA.CAP.	22uF	10V		TEESVB21A226M8R	K78100029		1-	A	D2
C 7590	CHIP CAP.	0.1uF	16V	B	GRM188B11C104KA01D	K22124805		1-	A	D2
C 7591	CHIP CAP.	0.22uF	10V	B	GRM188B11A224KA01D	K22104801		1-	B	g2
C 7592	CHIP CAP.	0.1uF	16V	B	GRM188B11C104KA01D	K22124805		1-	B	h2
C 7593	CHIP TA.CAP.	22uF	10V		TEESVB21A226M8R	K78100029		1-	A	D2
C 7594	CHIP TA.CAP.	10uF	16V		TEESVA1C106M8R	K78120077		1-	B	h2
C 7595	CHIP CAP.	56pF	50V	CH	GRM1882C1H560JA01D	K22174229		1-	B	e2
C 7596	CHIP CAP.	82pF	50V	CH	GRM1882C1H820JA01D	K22174233		1-	B	e2
C 7597	CHIP CAP.	0.1uF	16V	B	GRM188B11C104KA01D	K22124805		1-	A	B2
C 7598	CHIP TA.CAP.	10uF	16V		TEESVA1C106M8R	K78120077		1-	B	h3
C 7599	CHIP CAP.	0.1uF	16V	B	GRM188B11C104KA01D	K22124805		1-	A	D2
C 7600	CHIP TA.CAP.	1uF	35V		TEESVA1V105M8R	K78160032		1-	A	A2
C 7601	CHIP CAP.	0.1uF	16V	B	GRM188B11C104KA01D	K22124805		1-	B	h3
C 7602	CHIP TA.CAP.	22uF	6.3V		TEESVA0J226M8R	K78080047		1-	B	g1
C 7603	CHIP TA.CAP.	22uF	6.3V		TEESVA0J226M8R	K78080047		1-	B	g1
C 7604	CHIP CAP.	0.01uF	25V	B	GRM155B11E103KA01D	K22148834		1-	B	g2
C 7605	CHIP CAP.	0.22uF	10V	B	GRM155B31A224KE18D	K22108808		1-	B	g1
C 7606	CHIP CAP.	0.01uF	25V	B	GRM155B11E103KA01D	K22148834		1-	B	g1
C 7607	CHIP CAP.	0.22uF	10V	B	GRM155B31A224KE18D	K22108808		1-	B	g2
C 7608	CHIP CAP.	0.22uF	10V	B	GRM155B31A224KE18D	K22108808		1-	B	g1
C 7609	CHIP CAP.	0.01uF	25V	B	GRM155B11E103KA01D	K22148834		1-	B	g2
C 7610	CHIP CAP.	0.22uF	10V	B	GRM155B31A224KE18D	K22108808		1-	B	g1
C 7611	CHIP CAP.	0.01uF	25V	B	GRM155B11E103KA01D	K22148834		1-	B	g1
C 7612	CHIP CAP.	0.01uF	25V	B	GRM155B11E103KA01D	K22148834		1-	B	g1
C 7613	CHIP CAP.	0.22uF	10V	B	GRM155B31A224KE18D	K22108808		1-	B	g1
C 7614	CHIP TA.CAP.	22uF	6.3V		TEESVA0J226M8R	K78080047		1-	B	g2
C 7615	CHIP CAP.	0.01uF	25V	B	GRM155B11E103KA01D	K22148834		1-	B	g1
C 7616	CHIP CAP.	0.22uF	10V	B	GRM155B31A224KE18D	K22108808		1-	B	g1
C 7617	CHIP TA.CAP.	22uF	6.3V		TEESVA0J226M8R	K78080047		1-	B	g1
C 7618	CHIP CAP.	0.01uF	25V	B	GRM155B11E103KA01D	K22148834		1-	B	g1
C 7619	CHIP CAP.	0.22uF	10V	B	GRM155B31A224KE18D	K22108808		1-	B	g1
C 7620	CHIP CAP.	0.01uF	50V	B	GRM188B11H103KA01D	K22174823		1-	A	D1
C 7621	CHIP CAP.	0.22uF	10V	B	GRM188B11A224KA01D	K22104801		1-	A	D1
C 7622	CHIP CAP.	0.01uF	25V	B	GRM155B11E103KA01D	K22148834		1-	B	g1
C 7623	CHIP TA.CAP.	22uF	6.3V		TEESVA0J226M8R	K78080047		1-	B	g2
C 7624	CHIP CAP.	0.22uF	10V	B	GRM155B31A224KE18D	K22108808		1-	B	g2
C 7625	CHIP TA.CAP.	10uF	16V		TEESVA1C106M8R	K78120077		1-	B	g1
C 7626	CHIP CAP.	0.22uF	10V	B	GRM188B11A224KA01D	K22104801		1-	A	A1
C 7627	CHIP CAP.	0.01uF	25V	B	GRM155B11E103KA01D	K22148834		1-	B	g1
C 7628	CHIP CAP.	0.01uF	25V	B	GRM155B11E103KA01D	K22148834		1-	B	g2
C 7629	CHIP CAP.	0.1uF	16V	B	GRM188B11C104KA01D	K22124805		1-	B	g2
C 7630	CHIP CAP.	0.01uF	25V	B	GRM155B11E103KA01D	K22148834		1-	B	g2
C 7631	CHIP CAP.	0.22uF	10V	B	GRM155B31A224KE18D	K22108808		1-	B	g2
C 7632	CHIP CAP.	0.22uF	10V	B	GRM155B31A224KE18D	K22108808		1-	B	g2
C 7633	CHIP CAP.	0.22uF	10V	B	GRM155B31A224KE18D	K22108808		1-	B	g2
C 7634	CHIP CAP.	0.01uF	25V	B	GRM155B11E103KA01D	K22148834		1-	B	g2
C 7635	CHIP CAP.	0.22uF	10V	B	GRM155B31A224KE18D	K22108808		1-	B	g2
C 7636	CHIP CAP.	0.22uF	10V	B	GRM155B31A224KE18D	K22108808		1-	B	g2
C 7637	CHIP CAP.	0.22uF	10V	B	GRM155B31A224KE18D	K22108808		1-	B	g2
C 7638	CHIP CAP.	0.01uF	25V	B	GRM155B11E103KA01D	K22148834		1-	B	g2
C 7639	CHIP CAP.	0.22uF	10V	B	GRM188B11A224KA01D	K22104801		1-	A	B1
C 7640	CHIP TA.CAP.	22uF	6.3V		TEESVA0J226M8R	K78080047		1-	B	f1
C 7641	CHIP CAP.	0.01uF	25V	B	GRM155B11E103KA01D	K22148834		1-	B	g2
C 7642	CHIP CAP.	0.01uF	25V	B	GRM155B11E103KA01D	K22148834		1-	B	g1
C 7643	CHIP CAP.	0.22uF	10V	B	GRM155B31A224KE18D	K22108808		1-	B	g2
C 7644	CHIP CAP.	0.01uF	25V	B	GRM155B11E103KA01D	K22148834		1-	B	g2
C 7645	CHIP CAP.	0.1uF	16V	B	GRM188B11C104KA01D	K22124805		1-	B	g2
C 7646	CHIP TA.CAP.	22uF	6.3V		TEESVA0J226M8R	K78080047		1-	B	g1
C 7647	CHIP CAP.	0.22uF	10V	B	GRM155B31A224KE18D	K22108808		1-	B	g1
C 7648	CHIP CAP.	0.22uF	10V	B	GRM155B31A224KE18D	K22108808		1-	B	g1
C 7649	CHIP CAP.	0.01uF	25V	B	GRM155B11E103KA01D	K22148834		1-	B	g2
C 7650	CHIP CAP.	0.01uF	25V	B	GRM155B11E103KA01D	K22148834		1-	B	g2
C 7651	CHIP CAP.	0.22uF	10V	B	GRM155B31A224KE18D	K22108808		1-	B	g2
C 7652	CHIP CAP.	0.01uF	25V	B	GRM155B11E103KA01D	K22148834		1-	B	g2
C 7653	CHIP CAP.	0.22uF	10V	B	GRM155B31A224KE18D	K22108808		1-	B	g2
C 7654	CHIP CAP.	0.01uF	25V	B	GRM155B11E103KA01D	K22148834		1-	B	g2
C 7655	CHIP CAP.	0.22uF	10V	B	GRM155B31A224KE18D	K22108808		1-	B	g2
C 7656	CHIP TA.CAP.	22uF	6.3V		TEESVA0J226M8R	K78080047		1-	B	g2
D 7001	DIODE				BAS316	G2070716		1-	A	F3

DSP Unit

Parts List

REF	DESCRIPTION	VALUE	V/W	TOL.	MFR'S DESIG	VXSTD P/N	VERS.	LOT	SIDE	LAY ADR
D 7002	LED				SML-310VTT86JK	G2071032		1-	A	H2
D 7003	LED				SML-310VTT86JK	G2071032		1-	A	H2
D 7004	LED				SML-310VTT86JK	G2071032		1-	A	H2
D 7005	LED				SML-310VTT86JK	G2071032		1-	A	H2
D 7501	DIODE				BAS316	G2070716		1-	A	C1
D 7502	LED				SML-310VTT86JK	G2071032		1-	A	B1
D 7503	LED				SML-310VTT86JK	G2071032		1-	A	B1
D 7504	LED				SML-310VTT86JK	G2071032		1-	A	B1
D 7505	LED				SML-310VTT86JK	G2071032		1-	A	B1
FB7001	FERRITE BEADS				BLM18BD182SN1D	L1690602		1-	A	C3
FB7002	FERRITE BEADS				BK2125HS101-T	L9190087		1-	B	f3
FB7003	FERRITE BEADS				BK2125HS101-T	L9190087		1-	B	f3
FB7004	FERRITE BEADS				BLM18BD182SN1D	L1690602		1-	A	C3
FB7005	FERRITE BEADS				BLM18BD182SN1D	L1690602		1-	A	C3
FB7006	FERRITE BEADS				BLM18BD182SN1D	L1690602		1-	A	C3
FB7007	FERRITE BEADS				BLM18BD182SN1D	L1690602		1-	A	C3
FB7008	FERRITE BEADS				BLM18BD182SN1D	L1690602		1-	A	C3
FB7009	FERRITE BEADS				BLM18BD182SN1D	L1690602		1-	A	C3
FB7010	FERRITE BEADS				BK2125HS101-T	L9190087		1-	A	C3
FB7011	FERRITE BEADS				BK2125HS101-T	L9190087		1-	A	B3
FB7012	FERRITE BEADS				BLM18BD182SN1D	L1690602		1-	A	C3
FB7013	FERRITE BEADS				BLM18BD182SN1D	L1690602		1-	B	f3
J 7001	CONNECTOR				SB20-05WL	P0090844		1-	A	I1
J 7002	CONNECTOR				SB20-04WL	P0090826		1-	A	I2
J 7003	CONNECTOR				24FLT-SM2-TB(LF)(SN)(M)	P1091128		1-	A	C3
J 7501	CONNECTOR				SB20-05WL	P0090844		1-	A	A3
JP7001	WIRE AWG40-0.21PFA				GRN 65(2)/(2)	T9318336		2-4		
JP7501	WIRE AWG40-0.21PFA				GRN 65(2)/(2)	T9318336		2-4		
L 7001	CHIP COIL	100uH			CDRH5D28NP-101NC	L1691511		1-	A	E2
L 7002	CHIP COIL	100uH			CDRH5D28NP-101NC	L1691511		1-	A	E2
L 7003	CHIP COIL	6.2uH			CDRH5D28NP-6R2NC	L1691444		1-	A	E1
L 7004	CHIP COIL	6.2uH			CDRH5D28NP-6R2NC	L1691444		1-	A	E1
L 7503	CHIP COIL	6.2uH			CDRH5D28NP-6R2NC	L1691444		1-	A	D2
L 7504	CHIP COIL	6.2uH			CDRH5D28NP-6R2NC	L1691444		1-	A	D2
NF7001	EMC FILTER				ACF451832-153-TD01	Q9000915		1-	A	G2
NF7501	EMC FILTER				ACF451832-153-TD01	Q9000915		1-	A	B1
Q 7001	IC				NJM2068V-TE1	G1094112		1-	A	H2
Q 7002	IC				NJM2068V-TE1	G1094112		1-	A	H1
Q 7003	IC				NJM2068V-TE1	G1094112		1-	A	H1
Q 7004	IC				NJM2068V-TE1	G1094112		1-	A	H1
Q 7005	IC				ST16C550CQ48-F	G1094323		1-	A	F2
Q 7006	IC				NJM78L05UA-TE1	G1091325		1-	A	D1
Q 7007	IC				IS42S16800E-7TL	G1094321		1-	A	F1
Q 7008	IC				CS4272-CZZ	G1094319		1-	A	H1
Q 7009	IC				TPS3808G01	G1094325		1-	A	E3
Q 7010	IC				TPS62040DGQ	G1094328		1-	A	E2
Q 7011	IC				A29L400ATV-70F(AH036H)	G1094793		1-	A	G1
Q 7011	IC				A29L400ATV-70F R1685	G1094836		11-	A	G1
Q 7012	IC				TPS62046DGQ	G1094329		1-	A	E1
Q 7013	IC				TPS3103K33DBVR	G1094480		1-	A	F3
Q 7014	IC				TC7SH32FU(TE85L.F)	G1092729		1-	A	G1
Q 7015	IC				DAC7512N	G1094753		1-	A	H2
Q 7016	IC				TC7SH32FU(TE85L.F)	G1092729		1-	A	F2
Q 7017	IC				TMS320C6727BZDH300			1-	A	G2
Q 7501	IC				NJM2068V-TE1	G1094112		1-	A	A2
Q 7502	IC				NJM2068V-TE1	G1094112		1-	A	A2
Q 7503	IC				NJM2068V-TE1	G1094112		1-	A	A3
Q 7504	IC				NJM2068V-TE1	G1094112		1-	A	B2
Q 7505	IC				ST16C550CQ48-F	G1094323		1-	A	C2
Q 7508	IC				CS4272-CZZ	G1094319		1-	A	B3
Q 7510	IC				TPS62040DGQ	G1094328		1-	A	D2
Q 7511	IC				A29L400ATV-70F(AH036H)	G1094793		1-	A	C2
Q 7511	IC				A29L400ATV-70F R1685	G1094836		11-	A	C2
Q 7512	IC				TPS62046DGQ	G1094329		1-	A	D2
Q 7513	IC				TPS3103K33DBVR	G1094480		1-	A	C1
Q 7514	IC				TC7SH32FU(TE85L.F)	G1092729		1-	A	B3
Q 7515	IC				DAC7512N	G1094753		1-	A	B2
Q 7516	IC				TC7SH32FU(TE85L.F)	G1092729		1-	A	D2
Q 7517	IC				TMS320C6727BZDH300			1-	A	B2
R 7001	CHIP RES.	0	1/16W	5%	RMC1/16 00JATP	J24185000		1-	A	C3
R 7002	CHIP RES.	20k	1/16W	1%	RMC1/16 203FTP	J24183203		1-	A	H1
R 7004	CHIP RES.	1k	1/16W	1%	RMC1/16 102FTP	J24183102		1-	A	I2
R 7005	CHIP RES.	1k	1/16W	1%	RMC1/16 102FTP	J24183102		1-	A	I1

DSP Unit

Parts List

REF	DESCRIPTION	VALUE	V/W	TOL.	MFR'S DESIG	VXSTD P/N	VERS.	LOT	SIDE	LAY ADR
R 7006	CHIP RES.	15k	1/16W	1%	RMC1/16 153FTP	J24183153		1-	A	H2
R 7007	CHIP RES.	15k	1/16W	1%	RMC1/16 153FTP	J24183153		1-	A	H1
R 7008	CHIP RES.	10k	1/16W	5%	RMC1/16 103JATP	J24185103		1-	B	d2
R 7009	CHIP RES.	10k	1/16W	5%	RMC1/16 103JATP	J24185103		1	B	d2
R 7009	CHIP RES.	3.3k	1/16W	5%	RMC1/16 332JATP	J24185332		2-	B	d2
R 7010	CHIP RES.	33	1/16W	5%	RMC1/16 330JATP	J24185330		1-	A	F2
R 7011	CHIP RES.	33	1/16W	5%	RMC1/16 330JATP	J24185330		1-	A	F2
R 7012	CHIP RES.	5.6k	1/16W	1%	RMC1/16 562FTP	J24183562		1-	A	H2
R 7013	CHIP RES.	5.6k	1/16W	1%	RMC1/16 562FTP	J24183562		1-	A	H1
R 7014	CHIP RES.	10k	1/16W	5%	RMC1/16 103JATP	J24185103		1-	B	c2
R 7015	CHIP RES.	47k	1/16W	1%	RMC1/16 473FTP	J24183473		1-	A	H2
R 7016	CHIP RES.	47k	1/16W	1%	RMC1/16 473FTP	J24183473		1-	A	H1
R 7017	CHIP RES.	100	1/16W	1%	RMC1/16 101FTP	J24183101		1-	A	H1
R 7018	CHIP RES.	100	1/16W	1%	RMC1/16 101FTP	J24183101		1-	A	H1
R 7019	CHIP RES.	10k	1/16W	1%	RMC1/16 103FTP	J24183103		1-	A	H2
R 7020	CHIP RES.	10k	1/16W	1%	RMC1/16 103FTP	J24183103		1-	A	H1
R 7021	CHIP RES.	4.7k	1/16W	1%	RMC1/16 472FTP	J24183472		1-	A	H1
R 7022	CHIP RES.	4.7k	1/16W	1%	RMC1/16 472FTP	J24183472		1-	A	H2
R 7023	CHIP RES.	47k	1/16W	1%	RMC1/16 473FTP	J24183473		1-	A	H2
R 7024	CHIP RES.	1k	1/16W	1%	RMC1/16 102FTP	J24183102		1-	A	H1
R 7025	CHIP RES.	2.2k	1/16W	1%	RMC1/16 222FTP	J24183222		1-	A	H2
R 7026	CHIP RES.	2.2k	1/16W	1%	RMC1/16 222FTP	J24183222		1-	A	H1
R 7027	CHIP RES.	1.5k	1/16W	1%	RMC1/16 152FTP	J24183152		1-	A	H1
R 7028	CHIP RES.	4.7k	1/16W	1%	RMC1/16 472FTP	J24183472		1-	A	H1
R 7029	CHIP RES.	4.7k	1/16W	1%	RMC1/16 472FTP	J24183472		1-	A	H1
R 7030	CHIP RES.	4.7k	1/16W	1%	RMC1/16 472FTP	J24183472		1-	A	H1
R 7031	CHIP RES.	4.7k	1/16W	1%	RMC1/16 472FTP	J24183472		1-	A	H1
R 7032	CHIP RES.	4.7k	1/16W	1%	RMC1/16 472FTP	J24183472		1-	A	H2
R 7033	CHIP RES.	4.7k	1/16W	1%	RMC1/16 472FTP	J24183472		1-	A	H1
R 7034	CHIP RES.	4.7k	1/16W	1%	RMC1/16 472FTP	J24183472		1-	A	H1
R 7035	CHIP RES.	4.7k	1/16W	1%	RMC1/16 472FTP	J24183472		1-	A	H1
R 7036	CHIP RES.	4.7k	1/16W	1%	RMC1/16 472FTP	J24183472		1-	A	H1
R 7037	CHIP RES.	4.7k	1/16W	1%	RMC1/16 472FTP	J24183472		1-	A	H1
R 7038	CHIP RES.	0	1/16W	5%	RMC1/16 000JATP	J24185000		1-	A	F2
R 7039	CHIP RES.	1k	1/16W	1%	RMC1/16 102FTP	J24183102		1-	A	H2
R 7040	CHIP RES.	1k	1/16W	1%	RMC1/16 102FTP	J24183102		1-	A	H2
R 7041	CHIP RES.	1k	1/16W	1%	RMC1/16 102FTP	J24183102		1-	A	H1
R 7042	CHIP RES.	1k	1/16W	1%	RMC1/16 102FTP	J24183102		1-	A	H1
R 7043	CHIP RES.	7.5k	1/16W	1%	RMC1/16 752FTP	J24183752		1-	A	H2
R 7044	CHIP RES.	1k	1/16W	1%	RMC1/16 102FTP	J24183102		1-	A	H2
R 7045	CHIP RES.	4.7k	1/16W	1%	RMC1/16 472FTP	J24183472		1-	A	H1
R 7046	CHIP RES.	4.7k	1/16W	1%	RMC1/16 472FTP	J24183472		1-	A	H1
R 7047	CHIP RES.	4.7k	1/16W	1%	RMC1/16 472FTP	J24183472		1-	A	H1
R 7048	CHIP RES.	4.7k	1/16W	1%	RMC1/16 472FTP	J24183472		1-	A	H1
R 7049	CHIP RES.	1k	1/16W	1%	RMC1/16 102FTP	J24183102		1-	A	H1
R 7050	CHIP RES.	4.7	1/4W	5%	RMC1/4 4R7JATP	J24245479		1-	A	E2
R 7054	CHIP RES.	10k	1/16W	5%	RMC1/16 103JATP	J24185103		1-	A	E3
R 7055	CHIP RES.	0	1/16W	5%	RMC1/16 000JATP	J24185000		1-	A	G1
R 7056	CHIP RES.	10k	1/16W	5%	RMC1/16 103JATP	J24185103		1-	A	H1
R 7057	CHIP RES.	10k	1/16W	5%	RMC1/16 103JATP	J24185103		1-	B	b1
R 7058	CHIP RES.	0	1/16W	5%	RMC1/16 000JATP	J24185000		1-	A	G1
R 7060	CHIP RES.	10k	1/16W	5%	RMC1/16 103JATP	J24185103		1-	B	b1
R 7061	CHIP RES.	10k	1/16W	5%	RMC1/16 103JATP	J24185103		1-	B	b1
R 7062	CHIP RES.	10k	1/16W	5%	RMC1/16 103JATP	J24185103		1-	B	b1
R 7063	CHIP RES.	0	1/16W	5%	RMC1/16 000JATP	J24185000		1-	A	G1
R 7064	CHIP RES.	4.7k	1/16W	5%	RMC1/16 472JATP	J24185472		1-	A	F3
R 7065	CHIP RES.	0	1/16W	5%	RMC1/16 000JATP	J24185000		1-	A	G1
R 7066	CHIP RES.	10k	1/16W	5%	RMC1/16 103JATP	J24185103		1-	B	b1
R 7067	CHIP RES.	10k	1/16W	5%	RMC1/16 103JATP	J24185103		1-	A	G1
R 7068	CHIP RES.	0	1/16W	5%	RMC1/16 000JATP	J24185000		1-	A	G1
R 7069	CHIP RES.	33	1/16W	5%	RMC1/16 330JATP	J24185330		1-	A	G1
R 7070	CHIP RES.	10k	1/16W	5%	RMC1/16 103JATP	J24185103		1-	A	F1
R 7071	CHIP RES.	4.7k	1/16W	5%	RMC1/16 472JATP	J24185472		1-	A	F3
R 7072	CHIP RES.	10k	1/16W	5%	RMC1/16 103JATP	J24185103		1-	B	c1
R 7073	CHIP RES.	330k	1/16W	1%	RMC1/16 334FTP	J24183334		1-	B	d2
R 7074	CHIP RES.	220k	1/16W	1%	RMC1/16 224FTP	J24183224		1-	B	d2
R 7075	CHIP RES.	15k	1/16W	1%	RMC1/16 153FTP	J24183153		1-	B	d2
R 7076	CHIP RES.	10k	1/16W	1%	RMC1/16 103FTP	J24183103		1-	A	F3
R 7077	CHIP RES.	150k	1/16W	1%	RMC1/16 154FTP	J24183154		1-	A	F3
R 7078	CHIP RES.	150k	1/16W	1%	RMC1/16 154FTP	J24183154		1-	A	F3
R 7079	CHIP RES.	33	1/16W	5%	RMC1/16 330JATP	J24185330		1-	A	G1
R 7081	CHIP RES.	10k	1/16W	5%	RMC1/16 103JATP	J24185103		1-	A	F2
R 7087	CHIP RES.	1k	1/16W	5%	RMC1/16 102JATP	J24185102		1-	A	H2

DSP Unit

Parts List

REF	DESCRIPTION	VALUE	V/W	TOL.	MFR'S DESIG	VXSTD P/N	VERS.	LOT	SIDE	LAY ADR
R 7089	CHIP RES.	10k	1/16W	5%	RMC1/16 103JATP	J24185103		1-	A	G2
R 7090	CHIP RES.	0	1/16W	5%	RMC1/16 000JATP	J24185000		1-	A	F2
R 7092	CHIP RES.	0	1/16W	5%	RMC1/16 000JATP	J24185000		1-	A	G2
R 7093	CHIP RES.	33	1/16W	5%	RMC1/16 330JATP	J24185330		1-	A	G3
R 7094	CHIP RES.	33	1/16W	5%	RMC1/16 330JATP	J24185330		1-	A	G3
R 7095	CHIP RES.	10k	1/16W	5%	RMC1/16 103JATP	J24185103		1-	A	F3
R 7096	CHIP RES.	10k	1/16W	5%	RMC1/16 103JATP	J24185103		1-	A	F3
R 7097	CHIP RES.	10k	1/16W	5%	RMC1/16 103JATP	J24185103		1-	B	c2
R 7098	CHIP RES.	10k	1/16W	5%	RMC1/16 103JATP	J24185103		1-	A	H2
R 7099	CHIP RES.	10k	1/16W	5%	RMC1/16 103JATP	J24185103		1-	A	H2
R 7102	CHIP RES.	10k	1/16W	5%	RMC1/16 103JATP	J24185103		1-	A	H2
R 7103	CHIP RES.	10k	1/16W	5%	RMC1/16 103JATP	J24185103		1-	A	H2
R 7106	CHIP RES.	10k	1/16W	5%	RMC1/16 103JATP	J24185103		1-	A	F2
R 7107	CHIP RES.	10k	1/16W	5%	RMC1/16 103JATP	J24185103		1-	A	F2
R 7109	CHIP RES.	10k	1/16W	5%	RMC1/16 103JATP	J24185103		1-	A	G2
R 7111	CHIP RES.	1k	1/16W	5%	RMC1/16 102JATP	J24185102		1-	A	H2
R 7112	CHIP RES.	10k	1/16W	5%	RMC1/16 103JATP	J24185103		1-	A	F2
R 7113	CHIP RES.	1k	1/16W	5%	RMC1/16 102JATP	J24185102		1-	A	H2
R 7115	CHIP RES.	1k	1/16W	5%	RMC1/16 102JATP	J24185102		1-	A	H2
R 7121	CHIP RES.	33	1/16W	5%	RMC1/16 330JATP	J24185330		1-	B	b2
R 7122	CHIP RES.	10k	1/16W	5%	RMC1/16 103JATP	J24185103		1-	B	c3
R 7123	CHIP RES.	100	1/16W	5%	RMC1/16 101JATP	J24185101		1-	A	H2
R 7140	CHIP RES.	100	1/16W	5%	RMC1/16 101JATP	J24185101		1-	A	H2
R 7142	CHIP RES.	100	1/16W	5%	RMC1/16 101JATP	J24185101		1-	A	H2
R 7143	CHIP RES.	100	1/16W	5%	RMC1/16 101JATP	J24185101		1-	A	H2
R 7144	CHIP RES.	4.7k	1/16W	5%	RMC1/16 472JATP	J24185472		1-	B	b2
R 7158	CHIP RES.	4.7k	1/16W	5%	RMC1/16 472JATP	J24185472		1-	B	b2
R 7159	CHIP RES.	0	1/16W	5%	RMC1/16 000JATP	J24185000		1-	A	l1
R 7160	CHIP RES.	0	1/16W	5%	RMC1/16 000JATP	J24185000		1-	A	l1
R 7161	CHIP RES.	0	1/16W	5%	RMC1/16 000JATP	J24185000		1-	B	a1
R 7162	CHIP RES.	0	1/16W	5%	RMC1/16 000JATP	J24185000		1-	B	a1
R 7163	CHIP RES.	15k	1/16W	1%	RMC1/16 153FTP	J24183153		1-	A	E3
R 7164	CHIP RES.	150k	1/16W	1%	RMC1/16 154FTP	J24183154		1-	A	E3
R 7165	CARBON FILM RES.	100k	1/6W	5%	RD16TPJ104 100K	J07225104		2-	B	b1
R 7165	CHIP RES.	100k	1/16W	5%	RMC1/16 104JATP	J24185104		5-	B	b1
R 7502	CHIP RES.	20k	1/16W	1%	RMC1/16 203FTP	J24183203		1-	A	A2
R 7504	CHIP RES.	1k	1/16W	1%	RMC1/16 102FTP	J24183102		1-	A	A2
R 7505	CHIP RES.	1k	1/16W	1%	RMC1/16 102FTP	J24183102		1-	A	A2
R 7506	CHIP RES.	15k	1/16W	1%	RMC1/16 153FTP	J24183153		1-	A	A2
R 7507	CHIP RES.	15k	1/16W	1%	RMC1/16 153FTP	J24183153		1-	A	A2
R 7508	CHIP RES.	10k	1/16W	5%	RMC1/16 103JATP	J24185103		1-	B	f2
R 7509	CHIP RES.	10k	1/16W	5%	RMC1/16 103JATP	J24185103		1	B	f2
R 7509	CHIP RES.	3.3k	1/16W	5%	RMC1/16 332JATP	J24185332		2-	B	f2
R 7510	CHIP RES.	33	1/16W	5%	RMC1/16 330JATP	J24185330		1-	A	D2
R 7511	CHIP RES.	33	1/16W	5%	RMC1/16 330JATP	J24185330		1-	A	D2
R 7512	CHIP RES.	5.6k	1/16W	1%	RMC1/16 562FTP	J24183562		1-	A	A2
R 7513	CHIP RES.	5.6k	1/16W	1%	RMC1/16 562FTP	J24183562		1-	A	A2
R 7514	CHIP RES.	10k	1/16W	5%	RMC1/16 103JATP	J24185103		1-	B	f2
R 7515	CHIP RES.	47k	1/16W	1%	RMC1/16 473FTP	J24183473		1-	A	A3
R 7516	CHIP RES.	47k	1/16W	1%	RMC1/16 473FTP	J24183473		1-	A	A3
R 7517	CHIP RES.	100	1/16W	1%	RMC1/16 101FTP	J24183101		1-	A	A3
R 7518	CHIP RES.	100	1/16W	1%	RMC1/16 101FTP	J24183101		1-	A	A2
R 7519	CHIP RES.	10k	1/16W	1%	RMC1/16 103FTP	J24183103		1-	A	A2
R 7520	CHIP RES.	10k	1/16W	1%	RMC1/16 103FTP	J24183103		1-	A	A2
R 7521	CHIP RES.	4.7k	1/16W	1%	RMC1/16 472FTP	J24183472		1-	A	A2
R 7522	CHIP RES.	4.7k	1/16W	1%	RMC1/16 472FTP	J24183472		1-	A	A2
R 7523	CHIP RES.	47k	1/16W	1%	RMC1/16 473FTP	J24183473		1-	A	B2
R 7524	CHIP RES.	1k	1/16W	1%	RMC1/16 102FTP	J24183102		1-	A	B2
R 7525	CHIP RES.	2.2k	1/16W	1%	RMC1/16 222FTP	J24183222		1-	A	A2
R 7526	CHIP RES.	2.2k	1/16W	1%	RMC1/16 222FTP	J24183222		1-	A	A2
R 7527	CHIP RES.	1.5k	1/16W	1%	RMC1/16 152FTP	J24183152		1-	A	B2
R 7528	CHIP RES.	4.7k	1/16W	1%	RMC1/16 472FTP	J24183472		1-	A	A2
R 7529	CHIP RES.	4.7k	1/16W	1%	RMC1/16 472FTP	J24183472		1-	A	A2
R 7530	CHIP RES.	4.7k	1/16W	1%	RMC1/16 472FTP	J24183472		1-	A	A3
R 7531	CHIP RES.	4.7k	1/16W	1%	RMC1/16 472FTP	J24183472		1-	A	A3
R 7532	CHIP RES.	4.7k	1/16W	1%	RMC1/16 472FTP	J24183472		1-	A	A2
R 7533	CHIP RES.	4.7k	1/16W	1%	RMC1/16 472FTP	J24183472		1-	A	A2
R 7534	CHIP RES.	4.7k	1/16W	1%	RMC1/16 472FTP	J24183472		1-	A	A3
R 7535	CHIP RES.	4.7k	1/16W	1%	RMC1/16 472FTP	J24183472		1-	A	A2
R 7536	CHIP RES.	4.7k	1/16W	1%	RMC1/16 472FTP	J24183472		1-	A	A3
R 7537	CHIP RES.	4.7k	1/16W	1%	RMC1/16 472FTP	J24183472		1-	A	A3
R 7538	CHIP RES.	0	1/16W	5%	RMC1/16 000JATP	J24185000		1-	A	C2
R 7539	CHIP RES.	1k	1/16W	1%	RMC1/16 102FTP	J24183102		1-	A	A2

DSP Unit

Parts List

REF	DESCRIPTION	VALUE	V/W	TOL.	MFR'S DESIG	VXSTD P/N	VERS.	LOT	SIDE	LAY ADR
R 7540	CHIP RES.	1k	1/16W	1%	RMC1/16 102FTP	J24183102		1-	A	A2
R 7541	CHIP RES.	1k	1/16W	1%	RMC1/16 102FTP	J24183102		1-	A	A2
R 7542	CHIP RES.	1k	1/16W	1%	RMC1/16 102FTP	J24183102		1-	A	A2
R 7543	CHIP RES.	7.5k	1/16W	1%	RMC1/16 752FTP	J24183752		1-	A	B2
R 7544	CHIP RES.	1k	1/16W	1%	RMC1/16 102FTP	J24183102		1-	A	B2
R 7545	CHIP RES.	4.7k	1/16W	1%	RMC1/16 472FTP	J24183472		1-	A	A3
R 7546	CHIP RES.	4.7k	1/16W	1%	RMC1/16 472FTP	J24183472		1-	A	A2
R 7547	CHIP RES.	4.7k	1/16W	1%	RMC1/16 472FTP	J24183472		1-	A	A3
R 7548	CHIP RES.	4.7k	1/16W	1%	RMC1/16 472FTP	J24183472		1-	A	A3
R 7549	CHIP RES.	1k	1/16W	1%	RMC1/16 102FTP	J24183102		1-	A	B2
R 7550	CHIP RES.	4.7	1/4W	5%	RMC1/4 4R7JATP	J24245479		1-	A	E2
R 7555	CHIP RES.	0	1/16W	5%	RMC1/16 000JATP	J24185000		1-	A	B3
R 7556	CHIP RES.	10k	1/16W	5%	RMC1/16 103JATP	J24185103		1-	A	B2
R 7557	CHIP RES.	10k	1/16W	5%	RMC1/16 103JATP	J24185103		1-	B	g3
R 7558	CHIP RES.	0	1/16W	5%	RMC1/16 000JATP	J24185000		1-	A	B3
R 7560	CHIP RES.	10k	1/16W	5%	RMC1/16 103JATP	J24185103		1-	B	g2
R 7561	CHIP RES.	10k	1/16W	5%	RMC1/16 103JATP	J24185103		1-	B	g2
R 7562	CHIP RES.	10k	1/16W	5%	RMC1/16 103JATP	J24185103		1-	B	g3
R 7563	CHIP RES.	0	1/16W	5%	RMC1/16 000JATP	J24185000		1-	A	B3
R 7564	CHIP RES.	4.7k	1/16W	5%	RMC1/16 472JATP	J24185472		1-	A	C1
R 7565	CHIP RES.	0	1/16W	5%	RMC1/16 000JATP	J24185000		1-	A	B3
R 7566	CHIP RES.	10k	1/16W	5%	RMC1/16 103JATP	J24185103		1-	B	g2
R 7567	CHIP RES.	10k	1/16W	5%	RMC1/16 103JATP	J24185103		1-	A	B2
R 7568	CHIP RES.	0	1/16W	5%	RMC1/16 000JATP	J24185000		1-	A	B2
R 7569	CHIP RES.	33	1/16W	5%	RMC1/16 330JATP	J24185330		1-	A	B3
R 7570	CHIP RES.	10k	1/16W	5%	RMC1/16 103JATP	J24185103		1-	A	C2
R 7571	CHIP RES.	4.7k	1/16W	5%	RMC1/16 472JATP	J24185472		1-	A	C1
R 7572	CHIP RES.	10k	1/16W	5%	RMC1/16 103JATP	J24185103		1-	B	f2
R 7573	CHIP RES.	330k	1/16W	1%	RMC1/16 334FTP	J24183334		1-	B	e2
R 7574	CHIP RES.	220k	1/16W	1%	RMC1/16 224FTP	J24183224		1-	B	e2
R 7575	CHIP RES.	15k	1/16W	1%	RMC1/16 153FTP	J24183153		1-	B	e2
R 7576	CHIP RES.	10k	1/16W	1%	RMC1/16 103FTP	J24183103		1-	A	C1
R 7577	CHIP RES.	150k	1/16W	1%	RMC1/16 154FTP	J24183154		1-	A	C1
R 7578	CHIP RES.	150k	1/16W	1%	RMC1/16 154FTP	J24183154		1-	A	C1
R 7579	CHIP RES.	33	1/16W	5%	RMC1/16 330JATP	J24185330		1-	A	B3
R 7581	CHIP RES.	10k	1/16W	5%	RMC1/16 103JATP	J24185103		1-	A	D1
R 7587	CHIP RES.	1k	1/16W	5%	RMC1/16 102JATP	J24185102		1-	A	B1
R 7589	CHIP RES.	10k	1/16W	5%	RMC1/16 103JATP	J24185103		1-	A	C1
R 7590	CHIP RES.	0	1/16W	5%	RMC1/16 000JATP	J24185000		1-	A	C1
R 7592	CHIP RES.	0	1/16W	5%	RMC1/16 000JATP	J24185000		1-	A	C1
R 7594	CHIP RES.	33	1/16W	5%	RMC1/16 330JATP	J24185330		1-	B	g1
R 7595	CHIP RES.	10k	1/16W	5%	RMC1/16 103JATP	J24185103		1-	B	f1
R 7596	CHIP RES.	10k	1/16W	5%	RMC1/16 103JATP	J24185103		1-	B	f1
R 7597	CHIP RES.	10k	1/16W	5%	RMC1/16 103JATP	J24185103		1-	B	g1
R 7598	CHIP RES.	10k	1/16W	5%	RMC1/16 103JATP	J24185103		1-	A	A1
R 7599	CHIP RES.	10k	1/16W	5%	RMC1/16 103JATP	J24185103		1-	A	A1
R 7602	CHIP RES.	10k	1/16W	5%	RMC1/16 103JATP	J24185103		1-	A	A1
R 7603	CHIP RES.	10k	1/16W	5%	RMC1/16 103JATP	J24185103		1-	A	A1
R 7606	CHIP RES.	10k	1/16W	5%	RMC1/16 103JATP	J24185103		1-	A	C1
R 7607	CHIP RES.	10k	1/16W	5%	RMC1/16 103JATP	J24185103		1-	A	C1
R 7609	CHIP RES.	10k	1/16W	5%	RMC1/16 103JATP	J24185103		1-	A	C1
R 7611	CHIP RES.	1k	1/16W	5%	RMC1/16 102JATP	J24185102		1-	A	B1
R 7612	CHIP RES.	10k	1/16W	5%	RMC1/16 103JATP	J24185103		1-	A	C1
R 7613	CHIP RES.	1k	1/16W	5%	RMC1/16 102JATP	J24185102		1-	A	B1
R 7615	CHIP RES.	1k	1/16W	5%	RMC1/16 102JATP	J24185102		1-	A	B1
R 7621	CHIP RES.	33	1/16W	5%	RMC1/16 330JATP	J24185330		1-	B	g2
R 7622	CHIP RES.	10k	1/16W	5%	RMC1/16 103JATP	J24185103		1-	A	C1
R 7623	CHIP RES.	100	1/16W	5%	RMC1/16 101JATP	J24185101		1-	A	A1
R 7640	CHIP RES.	100	1/16W	5%	RMC1/16 101JATP	J24185101		1-	A	A2
R 7642	CHIP RES.	100	1/16W	5%	RMC1/16 101JATP	J24185101		1-	A	A1
R 7643	CHIP RES.	100	1/16W	5%	RMC1/16 101JATP	J24185101		1-	A	A1
R 7644	CHIP RES.	4.7k	1/16W	5%	RMC1/16 472JATP	J24185472		1-	B	g2
R 7658	CHIP RES.	4.7k	1/16W	5%	RMC1/16 472JATP	J24185472		1-	B	g2
R 7659	CHIP RES.	0	1/16W	5%	RMC1/16 000JATP	J24185000		1-	A	A3
R 7660	CHIP RES.	0	1/16W	5%	RMC1/16 000JATP	J24185000		1-	A	B3
R 7661	CHIP RES.	0	1/16W	5%	RMC1/16 000JATP	J24185000		1-	B	h3
R 7662	CHIP RES.	0	1/16W	5%	RMC1/16 000JATP	J24185000		1-	B	i3
R 7665	CARBON FILM RES.	100k	1/6W	5%	RD16TPJ104 100K	J07225104		2-	B	g2
R 7665	CHIP RES.	100k	1/16W	5%	RMC1/16 104JATP	J24185104		5-	B	g2
S 7001	TACT SWITCH				SKQYPAE010	N5090144		1-	A	D3
X 7001	XTAL OSC	18.432MHz			TPS18XC-E1 18.432MHZ	H9501010		1-	A	G1
X 7501	XTAL OSC	18.432MHz			TPS18XC-E1 18.432MHZ	H9501010		1-	A	B3

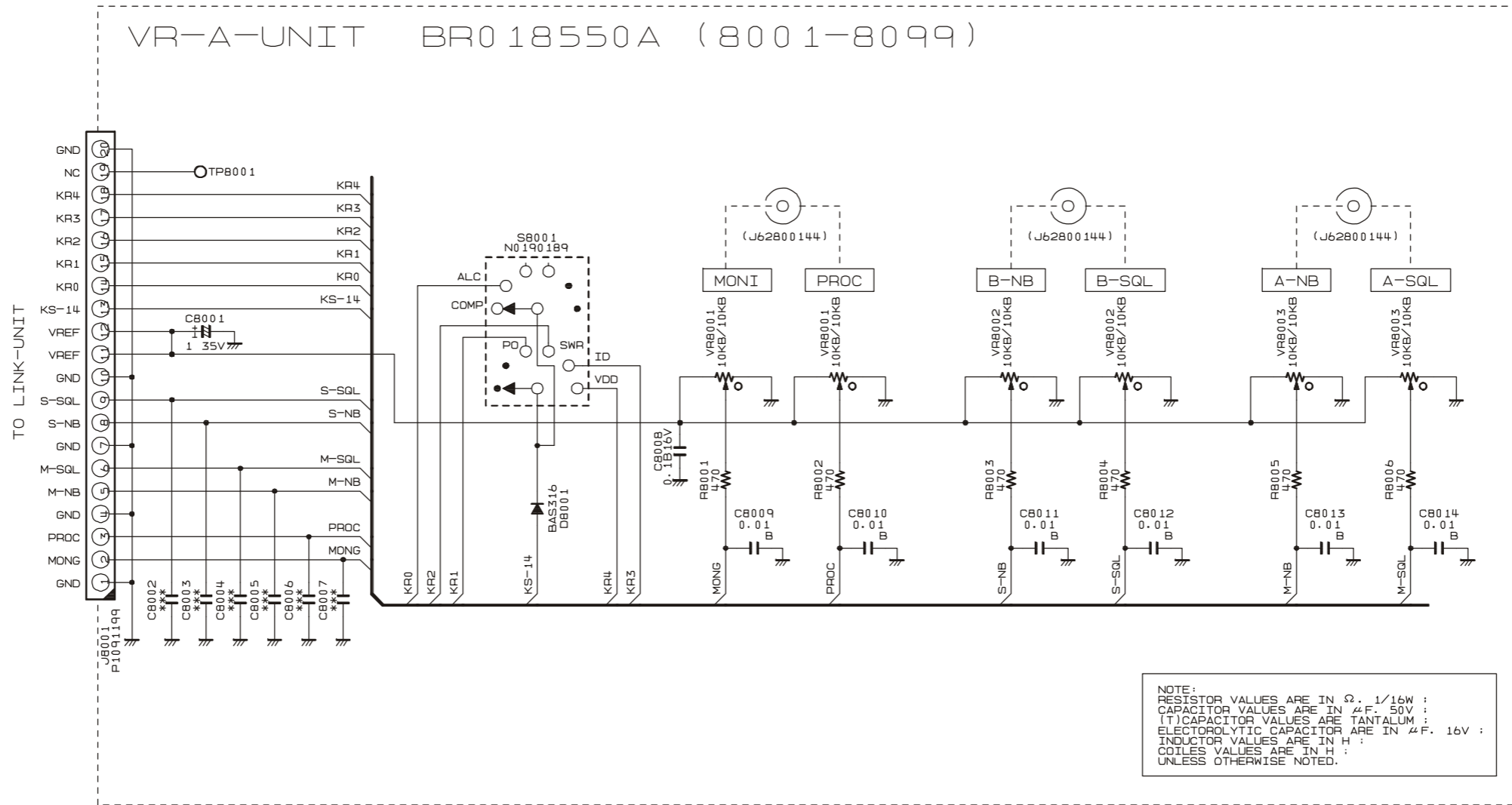

VR-A Unit

Parts Layout

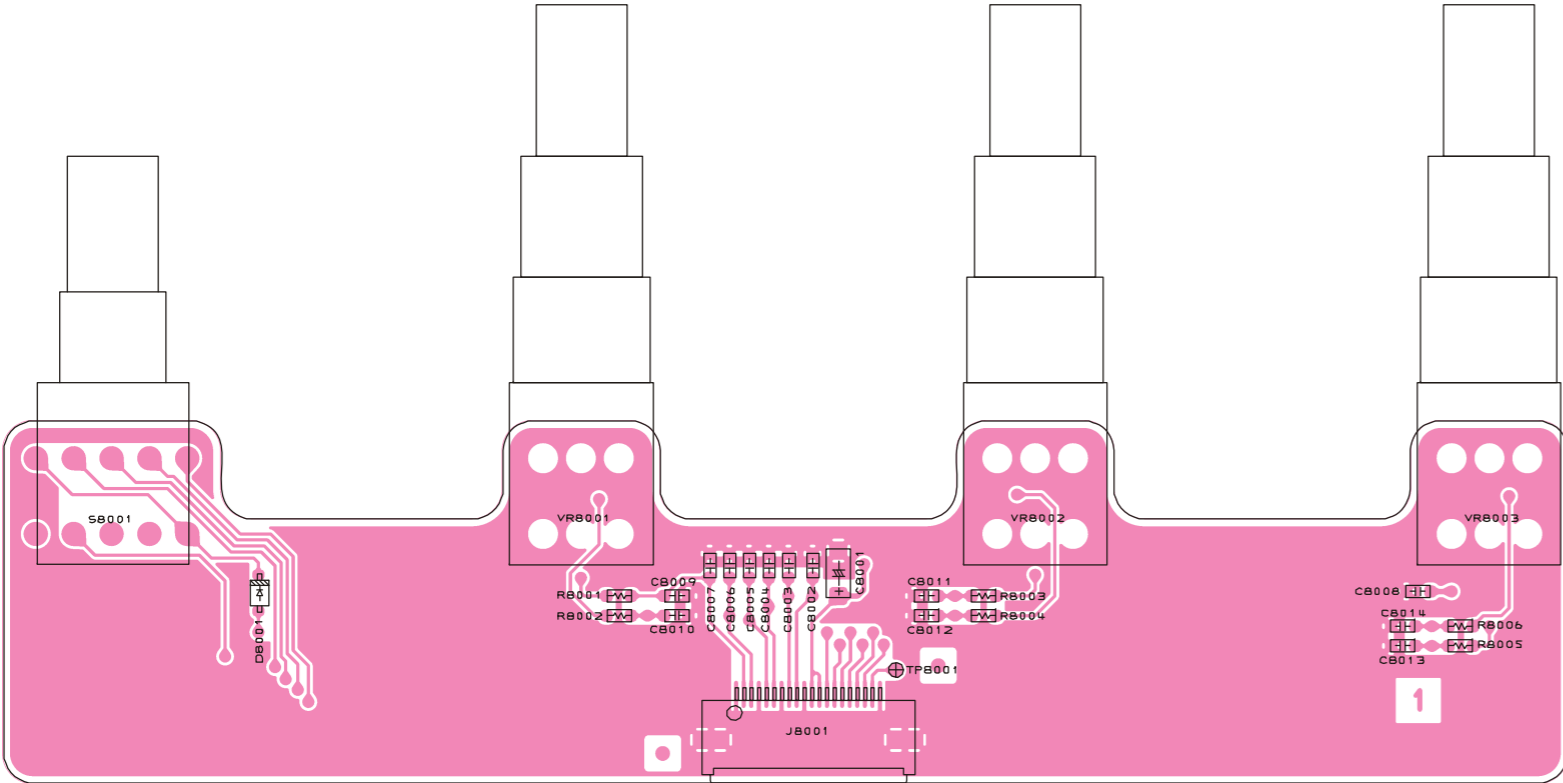

(Side A)

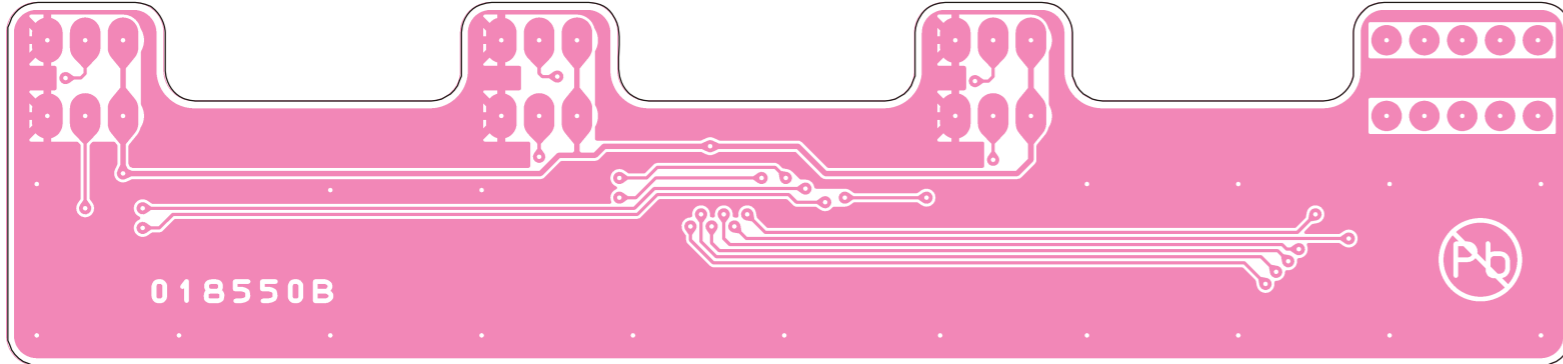

(Side B)

VR-A Unit

Parts List

REF	DESCRIPTION	VALUE	V/W	TOL.	MFR'S DESIG	VXSTD P/N	VERS.	LOT	SIDE	LAY ADR
	PCB with Components					CB4464001				
	Printed Circuit Board					FR018550B		1-		
C 8001	CHIP TA.CAP.	1uF	35V		TEESVA1V105M8R	K78160032		1-	A	C1
C 8008	CHIP CAP.	0.1uF	16V	B	GRM188B11C104KA01D	K22124805		1-	A	E1
C 8009	CHIP CAP.	0.01uF	50V	B	GRM188B11H103KA01D	K22174823		1-	A	C1
C 8010	CHIP CAP.	0.01uF	50V	B	GRM188B11H103KA01D	K22174823		1-	A	C1
C 8011	CHIP CAP.	0.01uF	50V	B	GRM188B11H103KA01D	K22174823		1-	A	D1
C 8012	CHIP CAP.	0.01uF	50V	B	GRM188B11H103KA01D	K22174823		1-	A	D1
C 8013	CHIP CAP.	0.01uF	50V	B	GRM188B11H103KA01D	K22174823		1-	A	E1
C 8014	CHIP CAP.	0.01uF	50V	B	GRM188B11H103KA01D	K22174823		1-	A	E1
D 8001	DIODE				BAS316	G2070716		1-	A	A1
J 8001	CONNECTOR				9637S-20-Y905	P1091199		1-	A	C2
R 8001	CHIP RES.	470	1/16W	5%	RMC1/16 471JATP	J24185471		1-	A	C1
R 8002	CHIP RES.	470	1/16W	5%	RMC1/16 471JATP	J24185471		1-	A	C1
R 8003	CHIP RES.	470	1/16W	5%	RMC1/16 471JATP	J24185471		1-	A	D1
R 8004	CHIP RES.	470	1/16W	5%	RMC1/16 471JATP	J24185471		1-	A	D1
R 8005	CHIP RES.	470	1/16W	5%	RMC1/16 471JATP	J24185471		1-	A	E1
R 8006	CHIP RES.	470	1/16W	5%	RMC1/16 471JATP	J24185471		1-	A	E1
S 8001	ROTARY SWITCH				SRBM160700	N0190189		1-	A	A1
VR8001	POT.				RK0972210-F25-C0-B103	J62800144		1-	A	B1
VR8002	POT.				RK0972210-F25-C0-B103	J62800144		1-	A	D1
VR8003	POT.				RK0972210-F25-C0-B103	J62800144		1-	A	E1

VR-A Unit

Note:

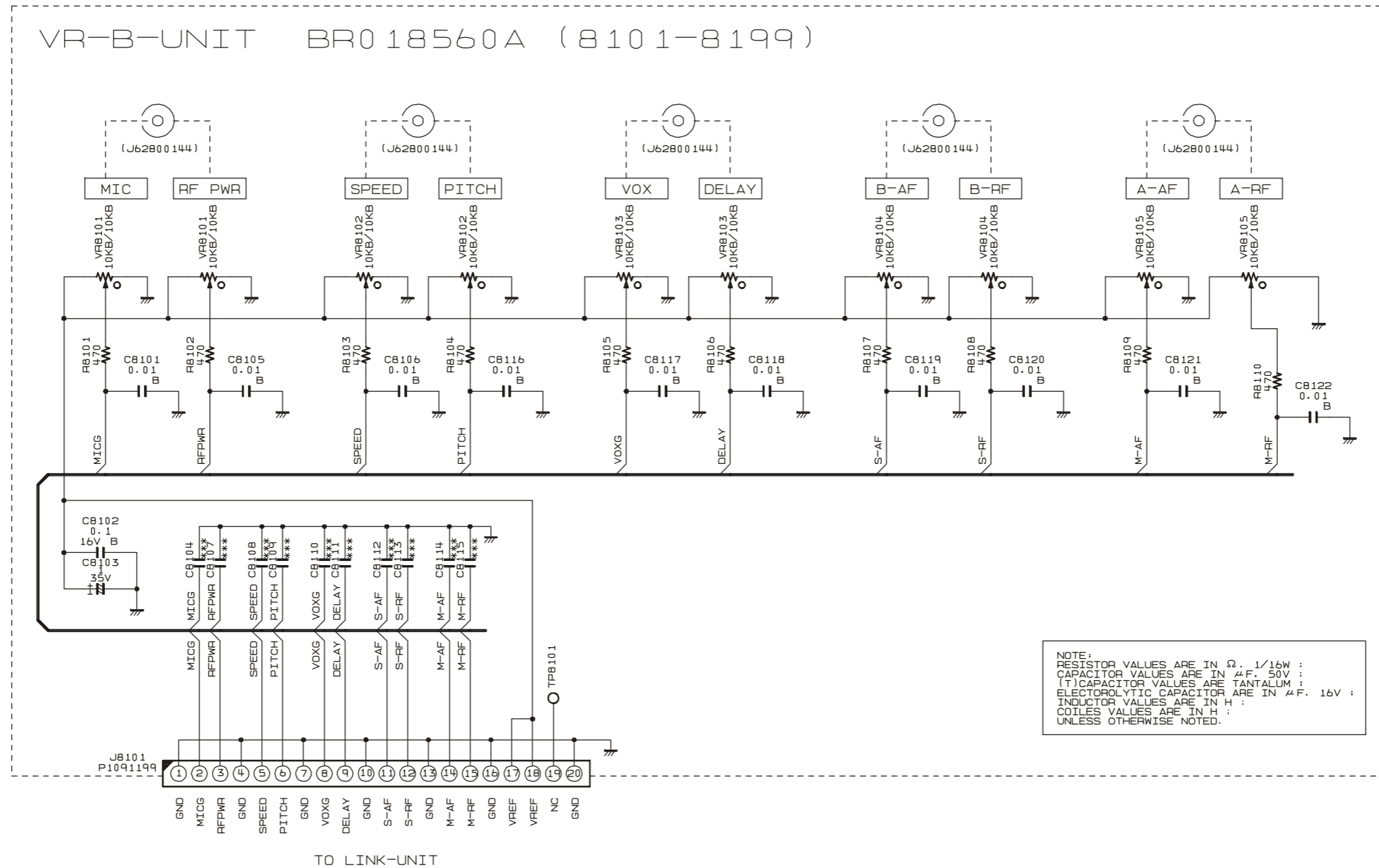

VR-B Unit

Parts Layout

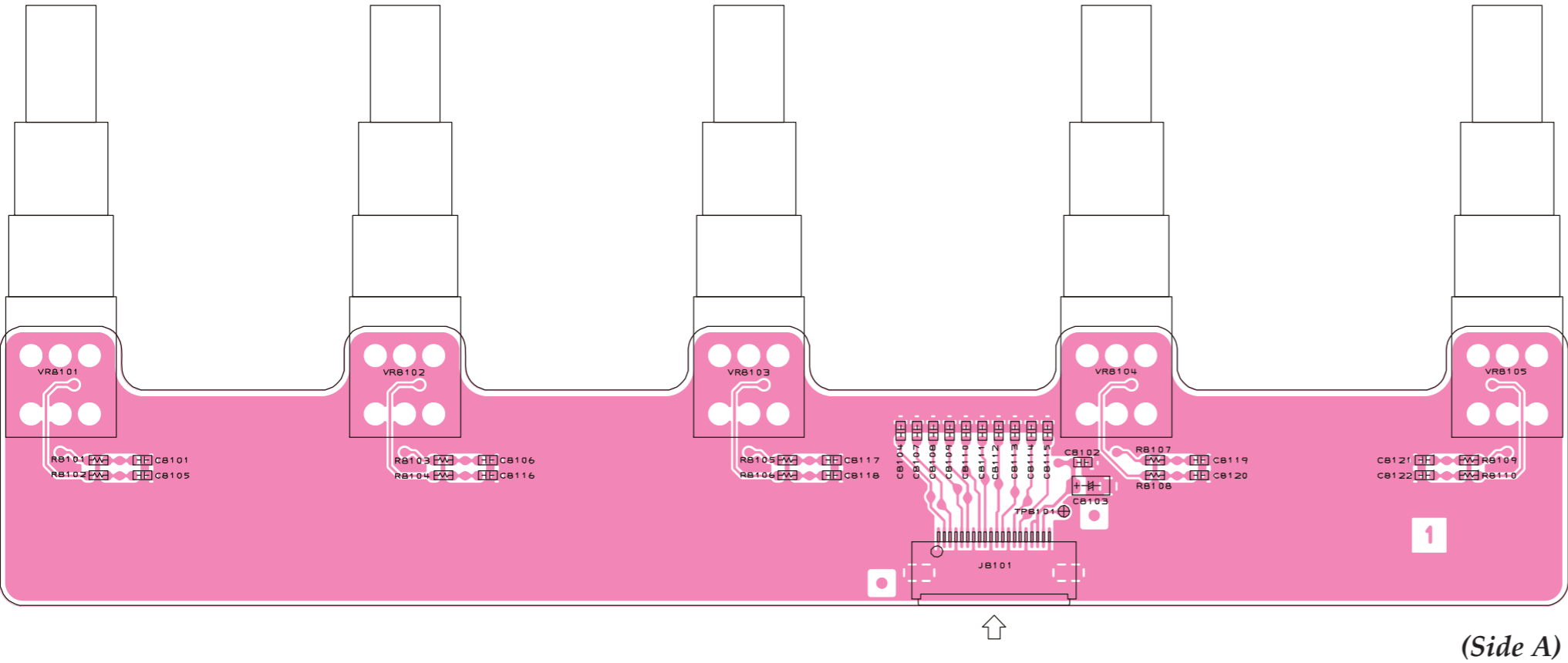

(Side A)

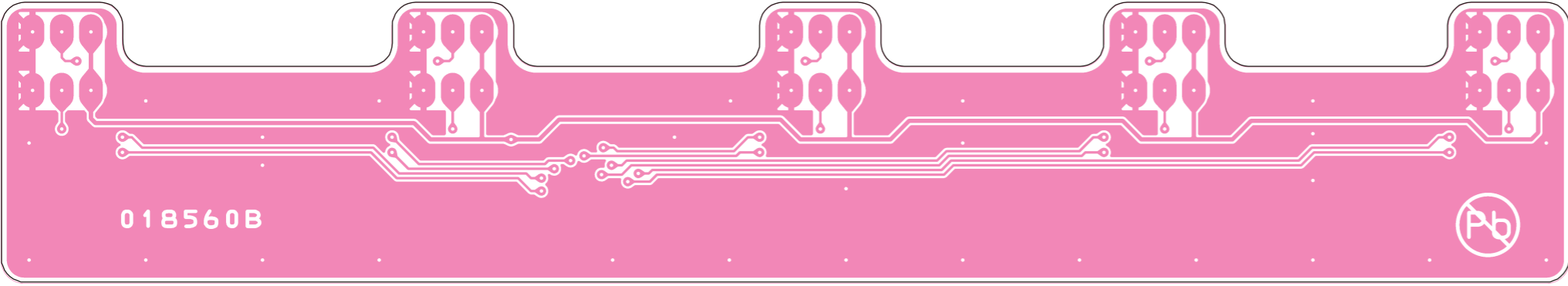

(Side B)

VR-B Unit

Parts List

REF	DESCRIPTION	VALUE	V/W	TOL.	MFR'S DESIG	VXSTD P/N	VERS.	LOT	SIDE	LAY ADR
	PCB with Components					CB4465001				
	Printed Circuit Board					FR018560B		1-		
C 8101	CHIP CAP.	0.01uF	50V	B	GRM188B11H103KA01D	K22174823		1-	A	A1
C 8102	CHIP CAP.	0.1uF	16V	B	GRM188B11C104KA01D	K22124805		1-	A	E1
C 8103	CHIP TA.CAP.	1uF	35V		TEESVA1V105M8R	K78160032		1-	A	E1
C 8105	CHIP CAP.	0.01uF	50V	B	GRM188B11H103KA01D	K22174823		1-	A	A1
C 8106	CHIP CAP.	0.01uF	50V	B	GRM188B11H103KA01D	K22174823		1-	A	C1
C 8116	CHIP CAP.	0.01uF	50V	B	GRM188B11H103KA01D	K22174823		1-	A	C1
C 8117	CHIP CAP.	0.01uF	50V	B	GRM188B11H103KA01D	K22174823		1-	A	D1
C 8118	CHIP CAP.	0.01uF	50V	B	GRM188B11H103KA01D	K22174823		1-	A	D1
C 8119	CHIP CAP.	0.01uF	50V	B	GRM188B11H103KA01D	K22174823		1-	A	F1
C 8120	CHIP CAP.	0.01uF	50V	B	GRM188B11H103KA01D	K22174823		1-	A	F1
C 8121	CHIP CAP.	0.01uF	50V	B	GRM188B11H103KA01D	K22174823		1-	A	G1
C 8122	CHIP CAP.	0.01uF	50V	B	GRM188B11H103KA01D	K22174823		1-	A	G1
J 8101	CONNECTOR				9637S-20-Y905	P1091199		1-	A	E2
R 8101	CHIP RES.	470	1/16W	5%	RMC1/16 471JATP	J24185471		1-	A	A1
R 8102	CHIP RES.	470	1/16W	5%	RMC1/16 471JATP	J24185471		1-	A	A1
R 8103	CHIP RES.	470	1/16W	5%	RMC1/16 471JATP	J24185471		1-	A	B1
R 8104	CHIP RES.	470	1/16W	5%	RMC1/16 471JATP	J24185471		1-	A	B1
R 8105	CHIP RES.	470	1/16W	5%	RMC1/16 471JATP	J24185471		1-	A	D1
R 8106	CHIP RES.	470	1/16W	5%	RMC1/16 471JATP	J24185471		1-	A	D1
R 8107	CHIP RES.	470	1/16W	5%	RMC1/16 471JATP	J24185471		1-	A	E1
R 8108	CHIP RES.	470	1/16W	5%	RMC1/16 471JATP	J24185471		1-	A	E1
R 8109	CHIP RES.	470	1/16W	5%	RMC1/16 471JATP	J24185471		1-	A	G1
R 8110	CHIP RES.	470	1/16W	5%	RMC1/16 471JATP	J24185471		1-	A	G1
VR8101	POT.				RK0972210-F25-C0-B103	J62800144		1-	A	A1
VR8102	POT.				RK0972210-F25-C0-B103	J62800144		1-	A	B1
VR8103	POT.				RK0972210-F25-C0-B103	J62800144		1-	A	D1
VR8104	POT.				RK0972210-F25-C0-B103	J62800144		1-	A	E1
VR8105	POT.				RK0972210-F25-C0-B103	J62800144		1-	A	G1

VR-B Unit

Note:

ENC Unit

Circuit Diagram

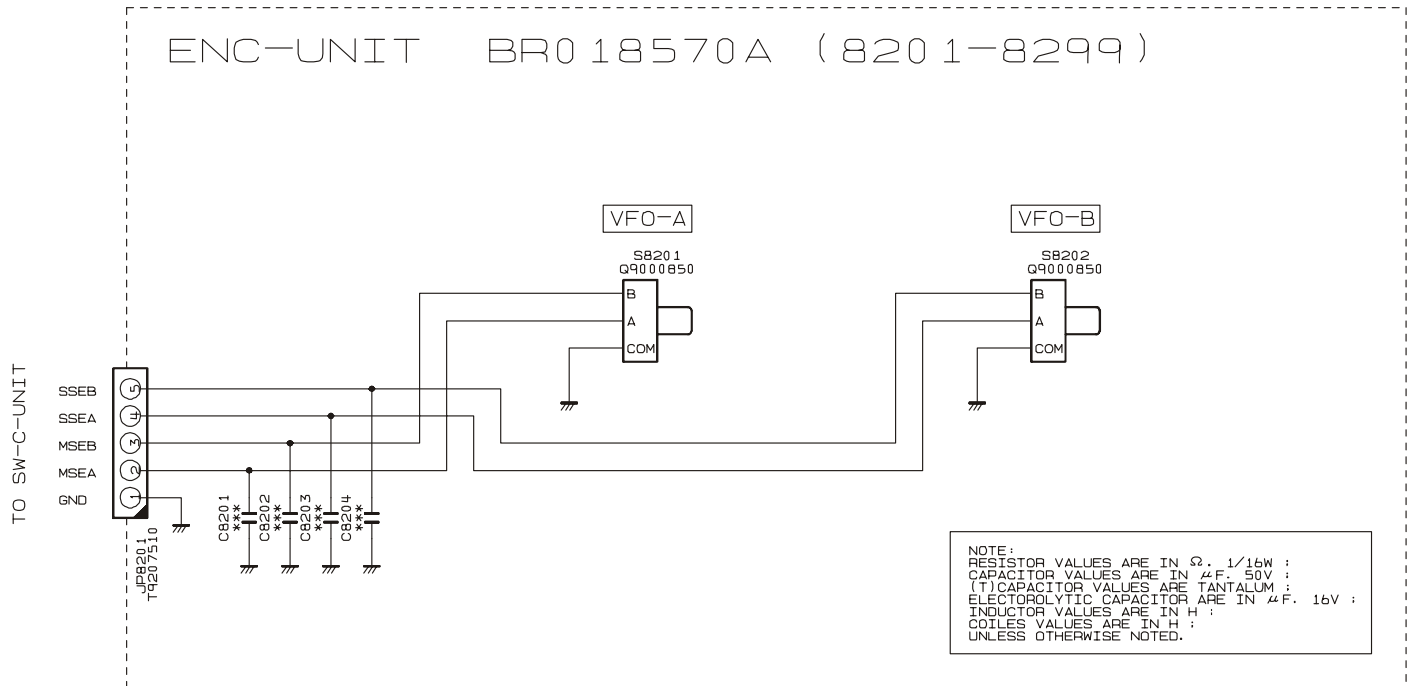

ENC Unit

Parts Layout

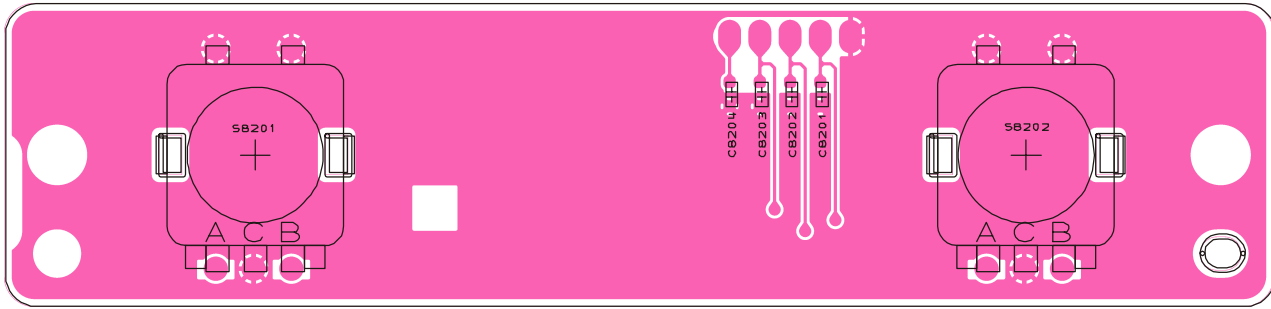

Side A

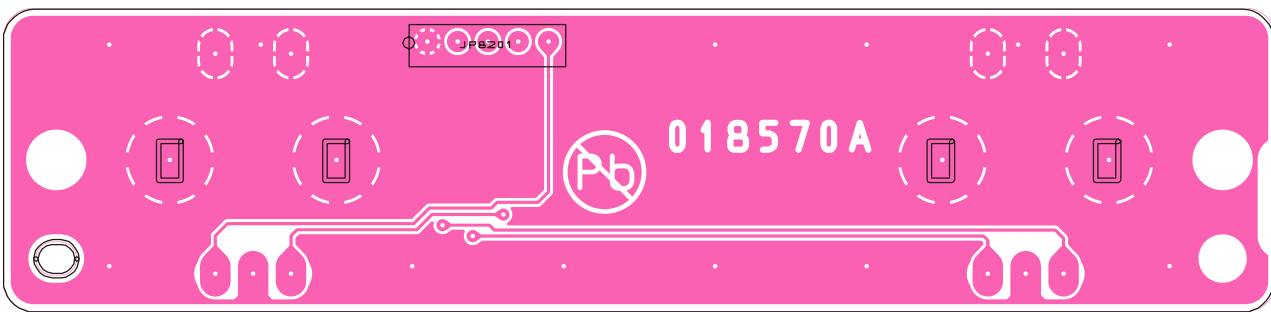

Side B

Parts List

REF	DESCRIPTION	VALUE	V/W	TOL.	MFR'S DESIG	VXSTD P/N	VERS.	LOT	SIDE	LAY ADR
	PCB with Components					CB4466001				
	Printed Circuit Board					FR018570A				
JP8201	WIRE ASSY				AH036H 70MM5P	T9207510		1-	B	
S 8201	ROTARY ENCODER				EC11G1520401	Q9000850		1-	A	
S 8202	ROTARY ENCODER				EC11G1520401	Q9000850		1-	A	

BACK-LIGHT Unit

Circuit Diagram

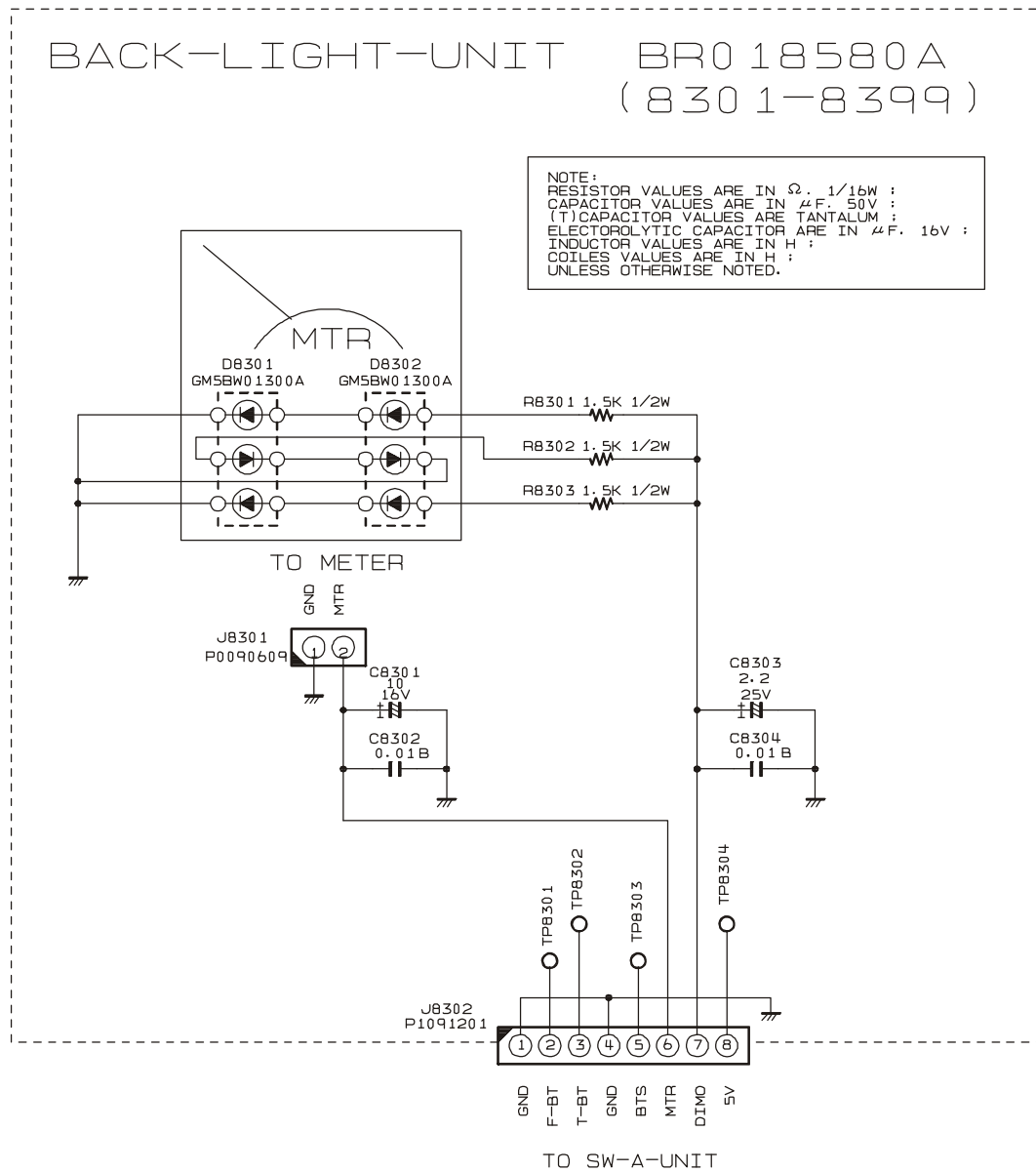

BACK-LIGHT Unit

Parts Layout

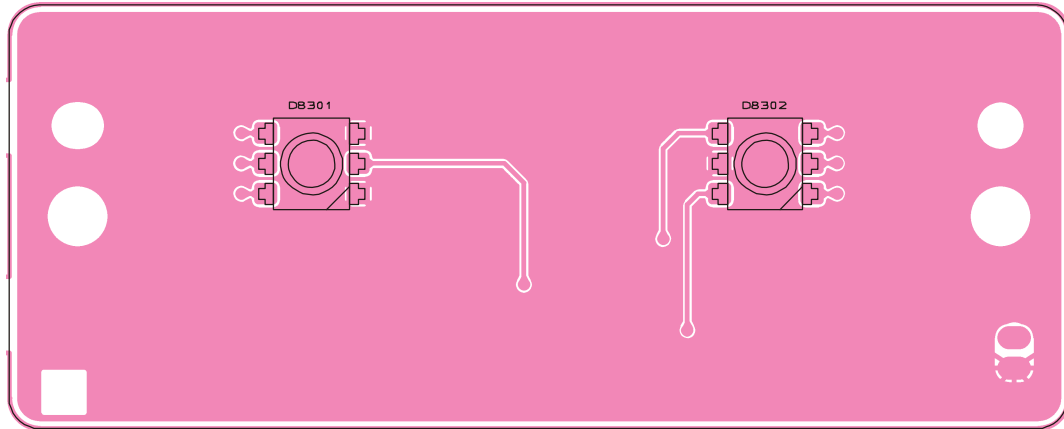

Side A

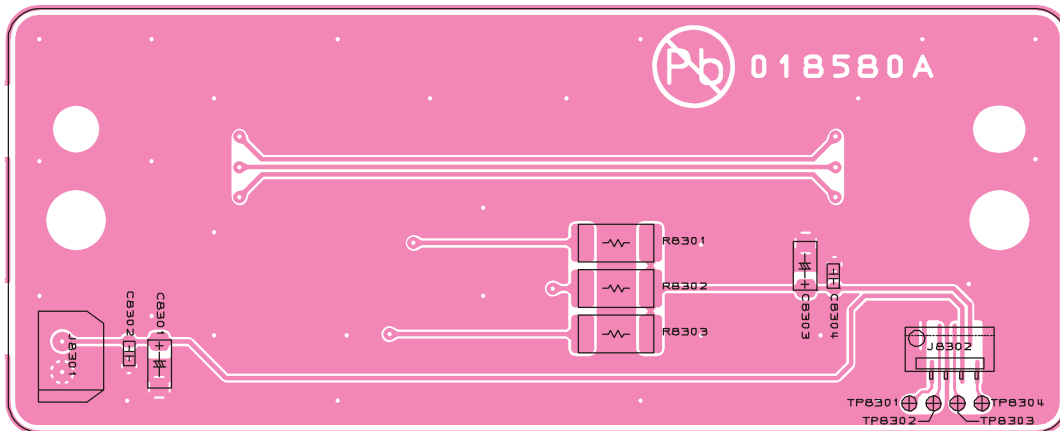

Side B

Parts List

REF	DESCRIPTION	VALUE	V/W	TOL.	MFR'S DESIG	VXSTD P/N	VERS.	LOT	SIDE	LAYADR
	PCB with Components					CB4467001				
	Printed Circuit Board					FR018580A		1-		
C 8301	CHIP TA.CAP.	10uF	16V		TEESVA1C106M8R	K78120077		1-	B	a2
C 8302	CHIPCAP.	0.01uF	50V	B	GRM188B11H103KA01D	K22174823		1-	B	a2
C 8303	CHIP TA.CAP.	2.2uF	25V		TEESVA1E225M8R	K78140020		1-	B	c1
C 8304	CHIPCAP.	0.01uF	50V	B	GRM188B11H103KA01D	K22174823		1-	B	c1
D 8301	LED				GM5BW01300A	G2071130		1-	A	B1
D 8302	LED				GM5BW01300A	G2071130		1-	A	C1
J 8301	CONNECTOR				SB20-02WS	P0090609		1-	B	a2
J 8302	CONNECTOR				08FLT-SM2-TB(LF)(SN)	P1091201		1-	B	d2
R 8301	CHIPRES.	1.5k	1/2W	5%	RMC1/2 152JCTP	J24275152		1-	B	c1
R 8302	CHIPRES.	1.5k	1/2W	5%	RMC1/2 152JCTP	J24275152		1-	B	c1
R 8303	CHIPRES.	1.5k	1/2W	5%	RMC1/2 152JCTP	J24275152		1-	B	c2

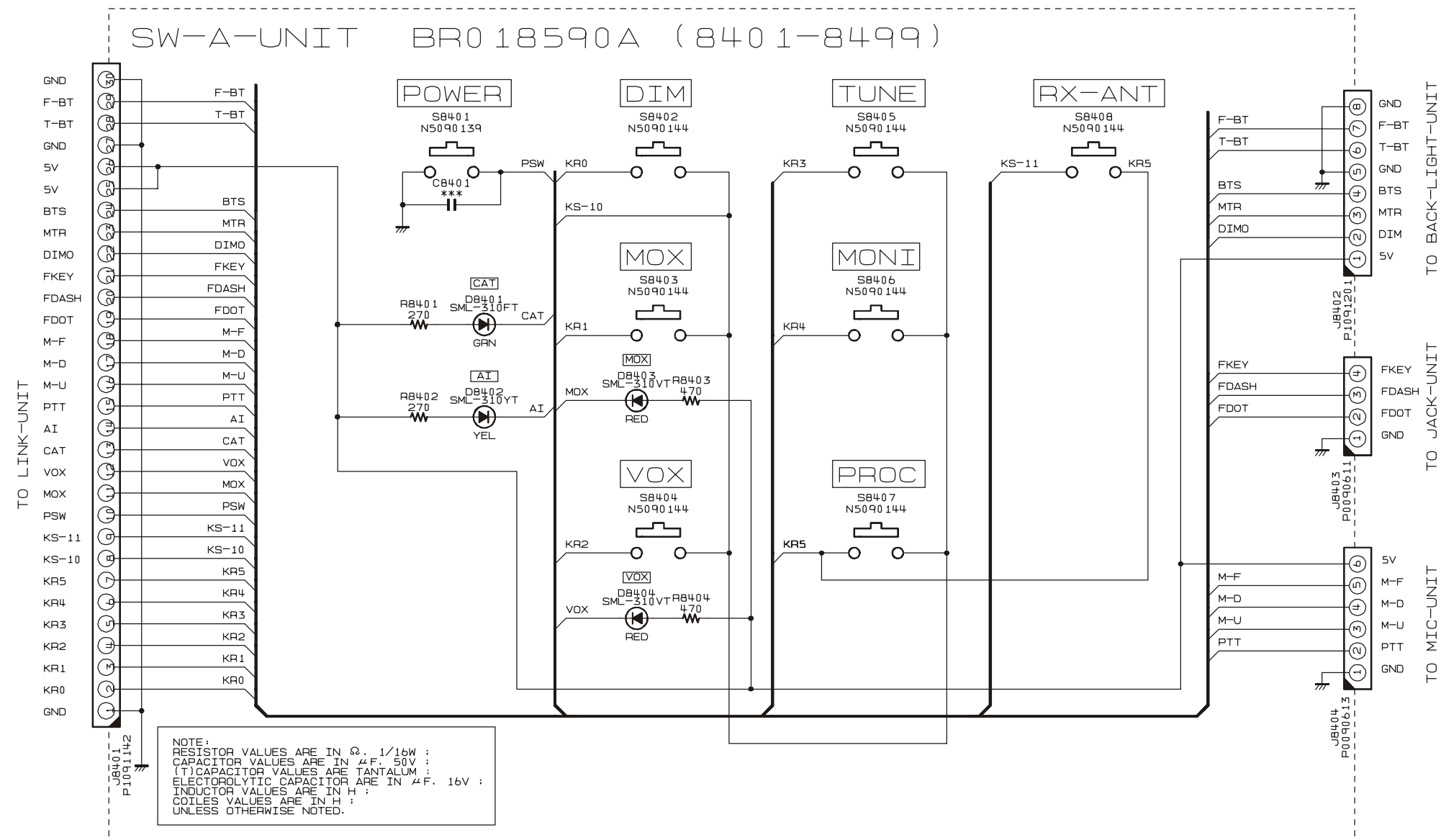

SW-A Unit

Note:

SW-A Unit

Parts Layout (Side A)

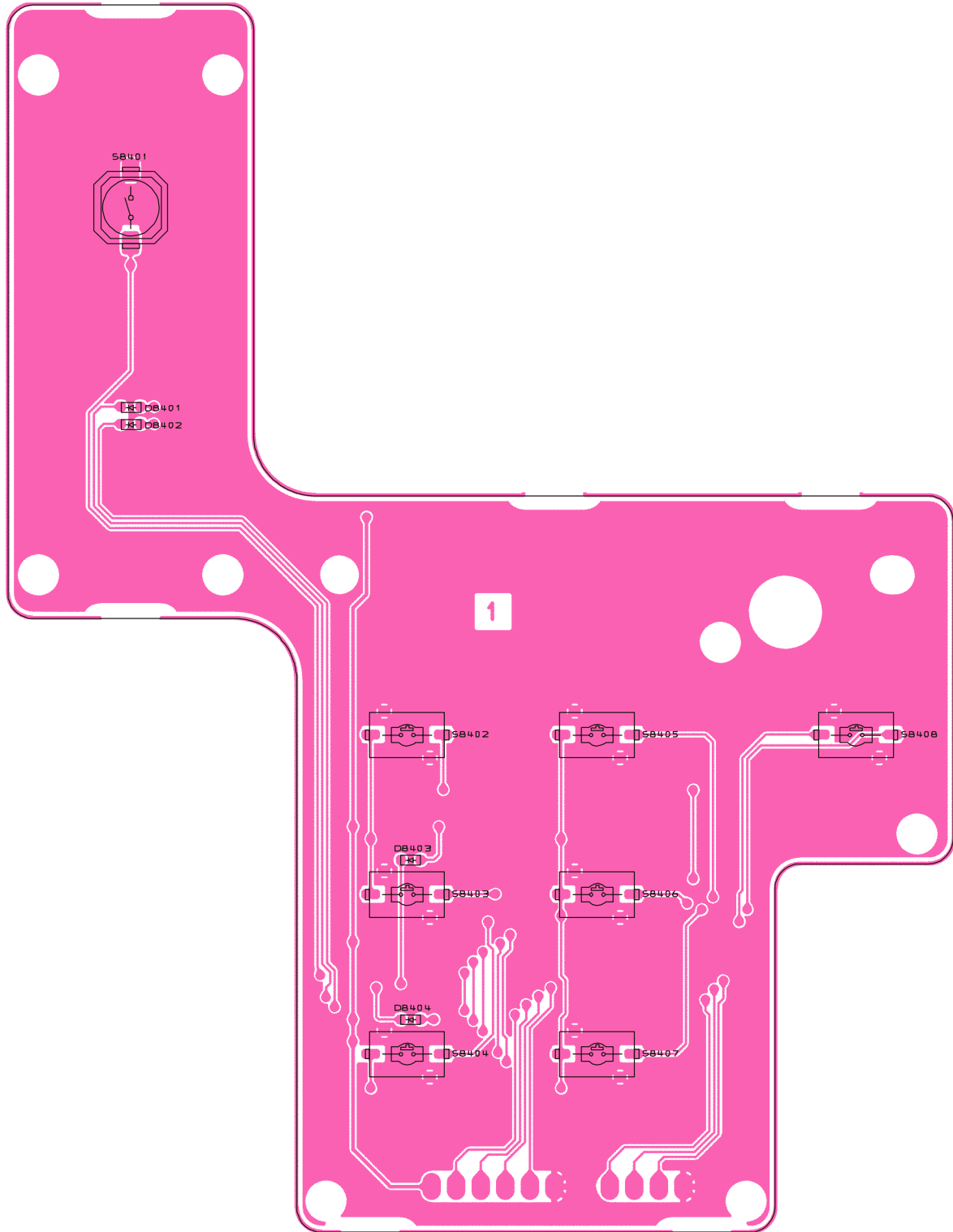

SW-A Unit

Parts Layout (Side B)

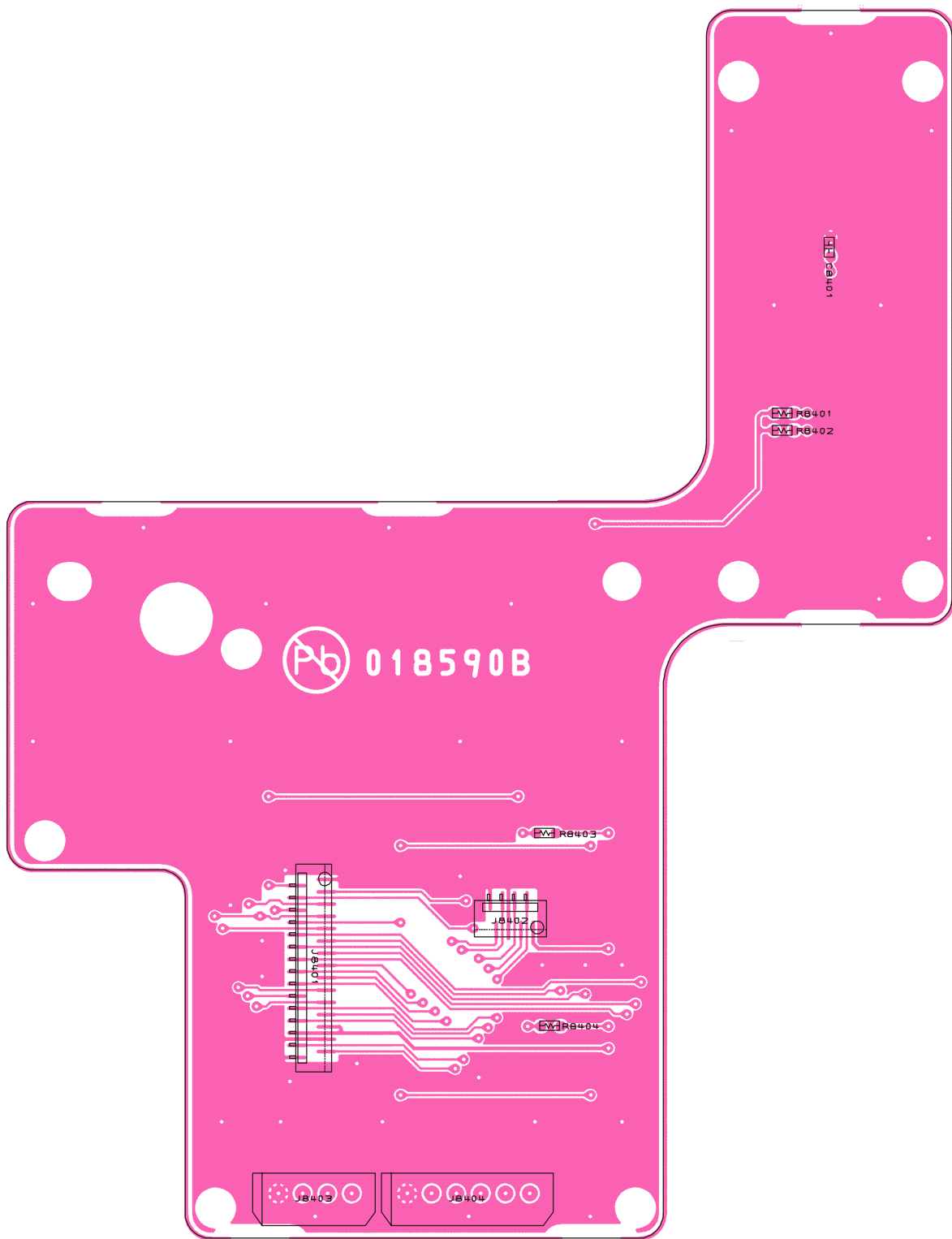

SW-A Unit

Note:

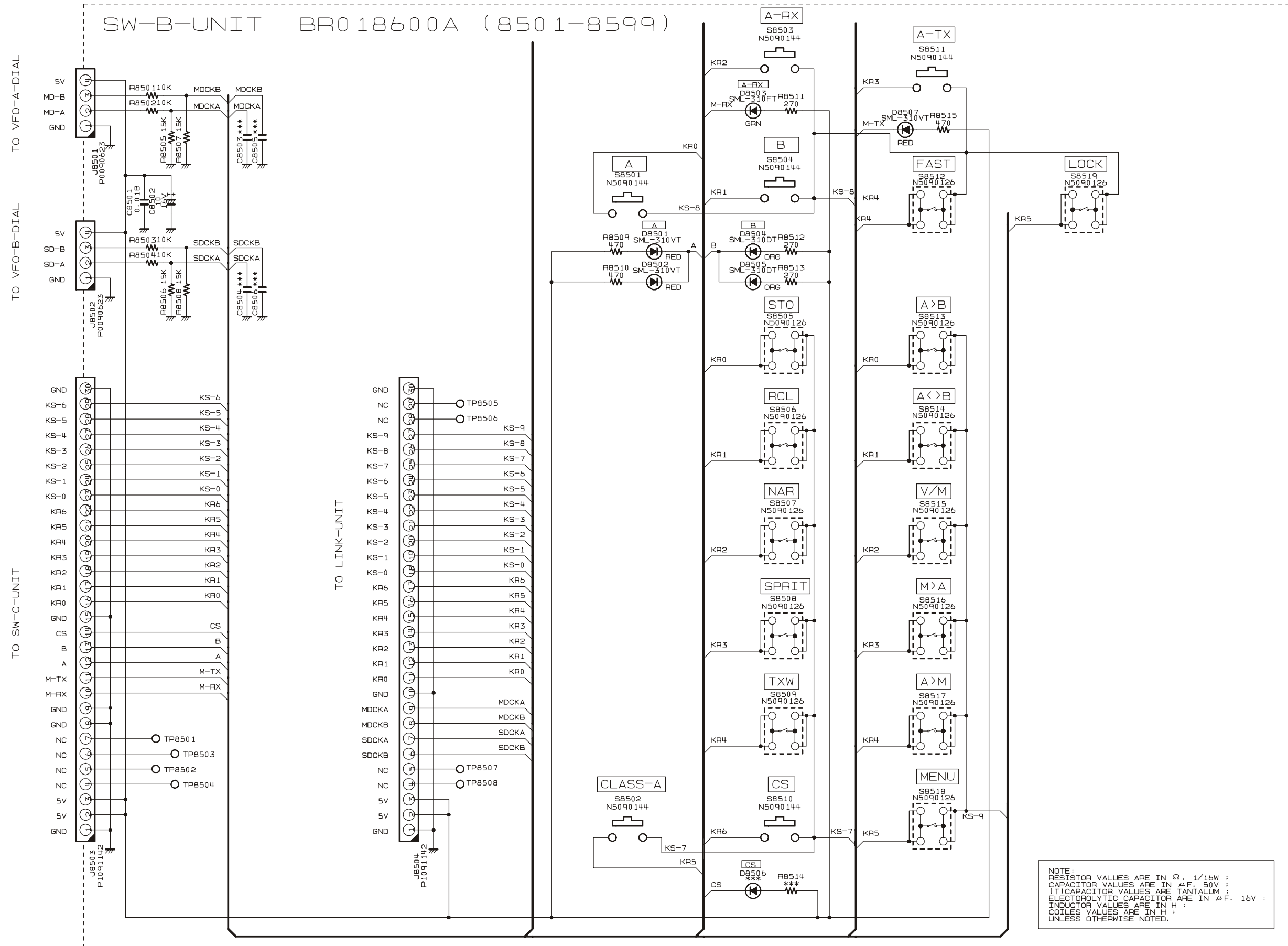

SW-B Unit

Note

SW-B Unit
Parts Layout (Side A)

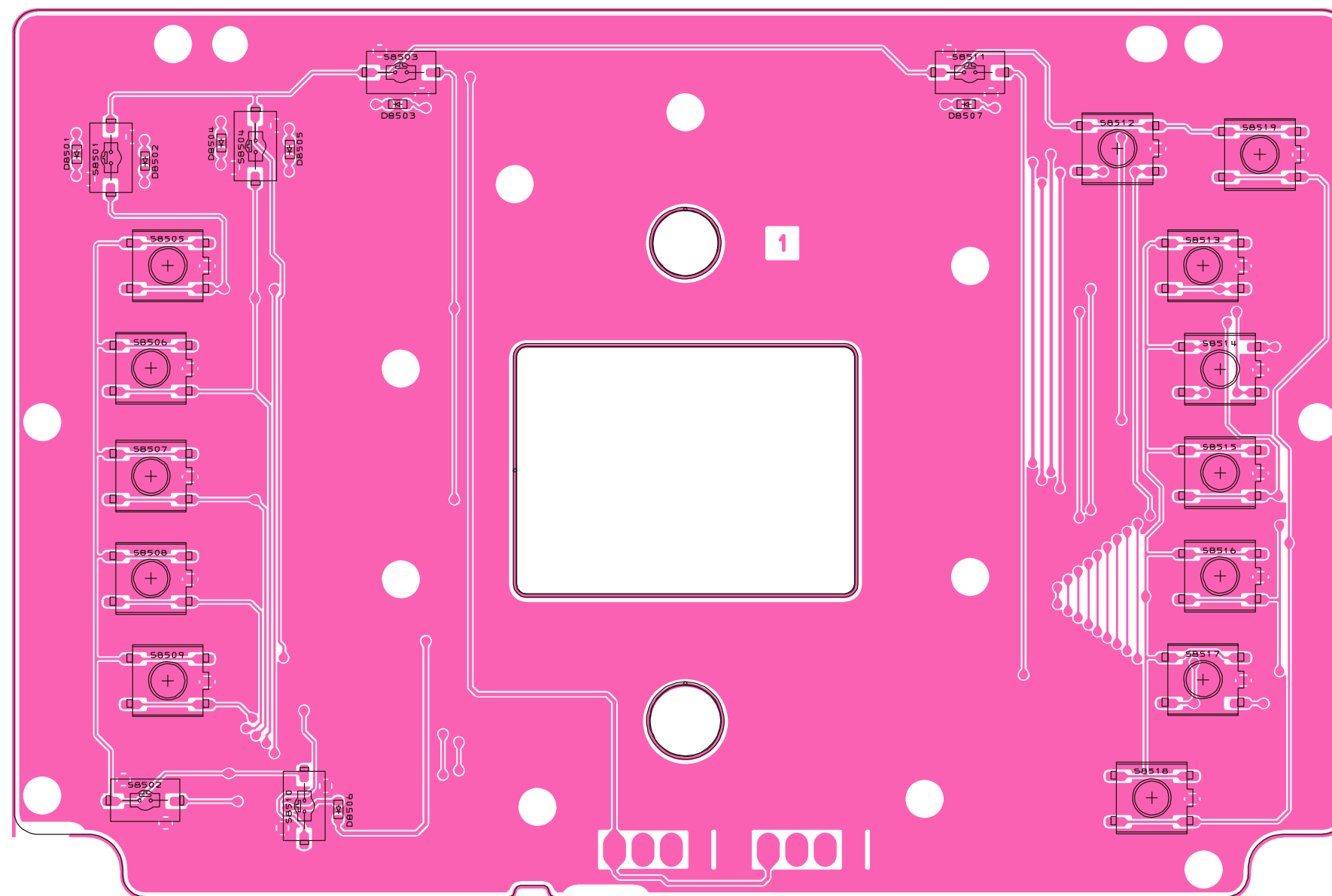

SW-B Unit

Parts Layout (Side B)

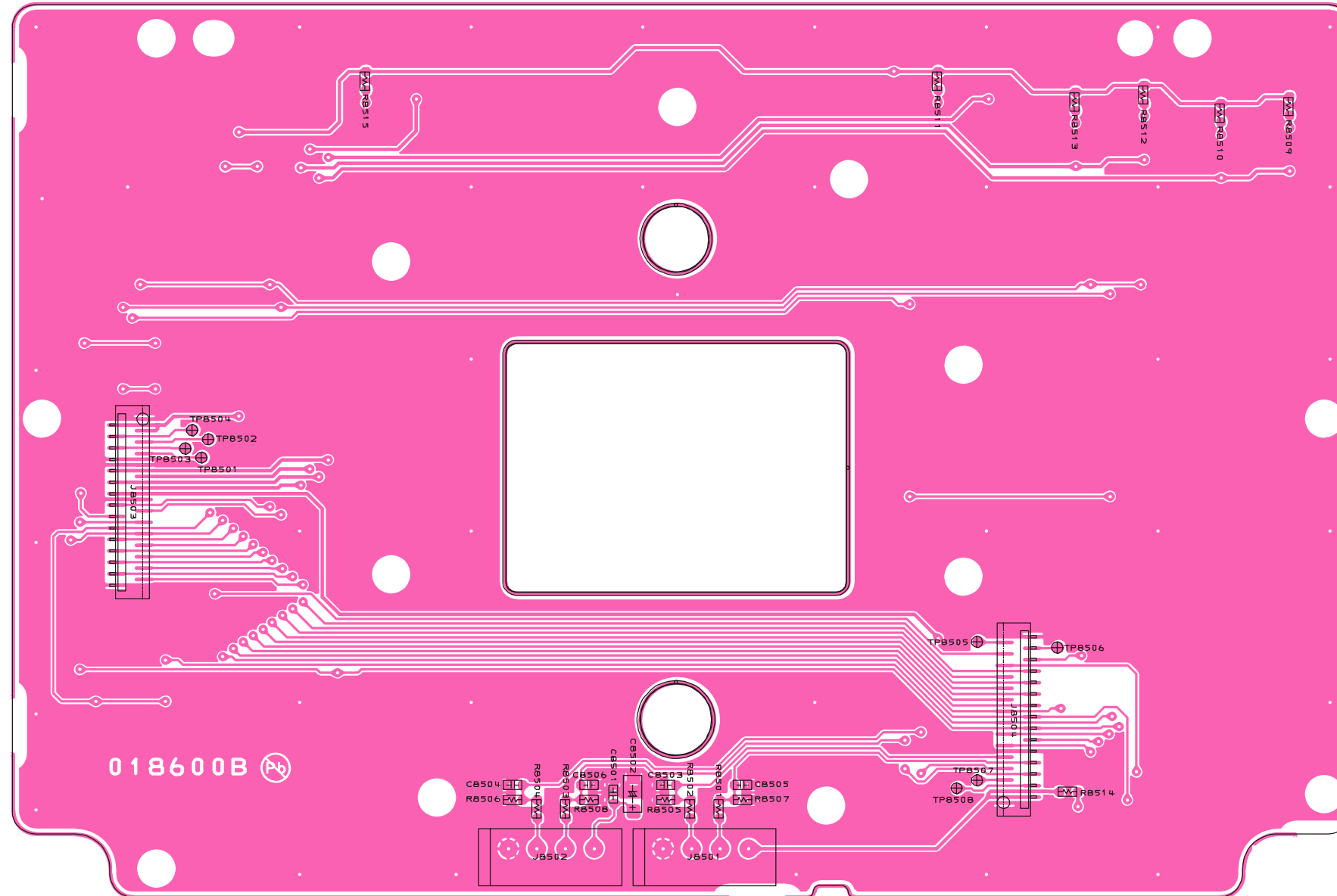

SW-B Unit

Parts List

REF	DESCRIPTION	VALUE	V/W	TOL.	MFR'S DESIG	VXSTD P/N	VERS.	LOT	SIDE	LAY ADR
	PCB with Components					CB4469001				
	Printed Circuit Board					FR018600B		1-		
C 8501	CHIP CAP.	0.01uF	50V	B	GRM188B11H103KA01D	K22174823		1-	B	c4
C 8502	CHIP TA.CAP.	10uF	16V		TEESVA1C106M8R	K78120077		1-	B	c4
D 8501	LED				SML-310VTT86JK	G2071032		1-	A	A1
D 8502	LED				SML-310VTT86JK	G2071032		1-	A	A1
D 8503	LED				SML-310FTT86KL	G2071026		1-	A	B1
D 8504	LED				SML-310DTT86KL	G2071024		1-	A	A1
D 8505	LED				SML-310DTT86KL	G2071024		1-	A	B1
D 8507	LED				SML-310VTT86JK	G2071032		1-	A	E1
J 8501	CONNECTOR				SC25-04WS	P0090623		1-	B	c4
J 8502	CONNECTOR				SC25-04WS	P0090623		1-	B	c4
J 8503	CONNECTOR				30FLT-SM2-TB(LF)(SN)(M)	P1091142		1-	B	a3
J 8504	CONNECTOR				30FLT-SM2-TB(LF)(SN)(M)	P1091142		1-	B	e4
R 8501	CHIP RES.	10k	1/16W	5%	RMC1/16 103JATP	J24185103		1-	B	d4
R 8502	CHIP RES.	10k	1/16W	5%	RMC1/16 103JATP	J24185103		1-	B	c4
R 8503	CHIP RES.	10k	1/16W	5%	RMC1/16 103JATP	J24185103		1-	B	c4
R 8504	CHIP RES.	10k	1/16W	5%	RMC1/16 103JATP	J24185103		1-	B	c4
R 8505	CHIP RES.	15k	1/16W	5%	RMC1/16 153JATP	J24185153		1-	B	c4
R 8506	CHIP RES.	15k	1/16W	5%	RMC1/16 153JATP	J24185153		1-	B	c4
R 8507	CHIP RES.	15k	1/16W	5%	RMC1/16 153JATP	J24185153		1-	B	d4
R 8508	CHIP RES.	15k	1/16W	5%	RMC1/16 153JATP	J24185153		1-	B	c4
R 8509	CHIP RES.	470	1/16W	5%	RMC1/16 471JATP	J24185471		1-	B	f1
R 8510	CHIP RES.	470	1/16W	5%	RMC1/16 471JATP	J24185471		1-	B	f1
R 8511	CHIP RES.	270	1/16W	5%	RMC1/16 271JATP	J24185271		1-	B	e1
R 8512	CHIP RES.	270	1/16W	5%	RMC1/16 271JATP	J24185271		1-	B	e1
R 8513	CHIP RES.	270	1/16W	5%	RMC1/16 271JATP	J24185271		1-	B	e1
R 8515	CHIP RES.	470	1/16W	5%	RMC1/16 471JATP	J24185471		1-	B	b1
S 8501	TACT SWITCH				SKQYPAE010	N5090144		1-	A	A1
S 8502	TACT SWITCH				SKQYPAE010	N5090144		1-	A	A4
S 8503	TACT SWITCH				SKQYPAE010	N5090144		1-	A	B1
S 8504	TACT SWITCH				SKQYPAE010	N5090144		1-	A	B1
S 8505	TACT SWITCH				SKHUPLE010	N5090126		1-	A	A2
S 8506	TACT SWITCH				SKHUPLE010	N5090126		1-	A	A2
S 8507	TACT SWITCH				SKHUPLE010	N5090126		1-	A	A3
S 8508	TACT SWITCH				SKHUPLE010	N5090126		1-	A	A3
S 8509	TACT SWITCH				SKHUPLE010	N5090126		1-	A	A3
S 8510	TACT SWITCH				SKQYPAE010	N5090144		1-	A	B4
S 8511	TACT SWITCH				SKQYPAE010	N5090144		1-	A	E1
S 8512	TACT SWITCH				SKHUPLE010	N5090126		1-	A	E1
S 8513	TACT SWITCH				SKHUPLE010	N5090126		1-	A	F2
S 8514	TACT SWITCH				SKHUPLE010	N5090126		1-	A	F2
S 8515	TACT SWITCH				SKHUPLE010	N5090126		1-	A	F3
S 8516	TACT SWITCH				SKHUPLE010	N5090126		1-	A	F3
S 8517	TACT SWITCH				SKHUPLE010	N5090126		1-	A	F3
S 8518	TACT SWITCH				SKHUPLE010	N5090126		1-	A	F4
S 8519	TACT SWITCH				SKHUPLE010	N5090126		1-	A	F1

SW-B Unit

Note:

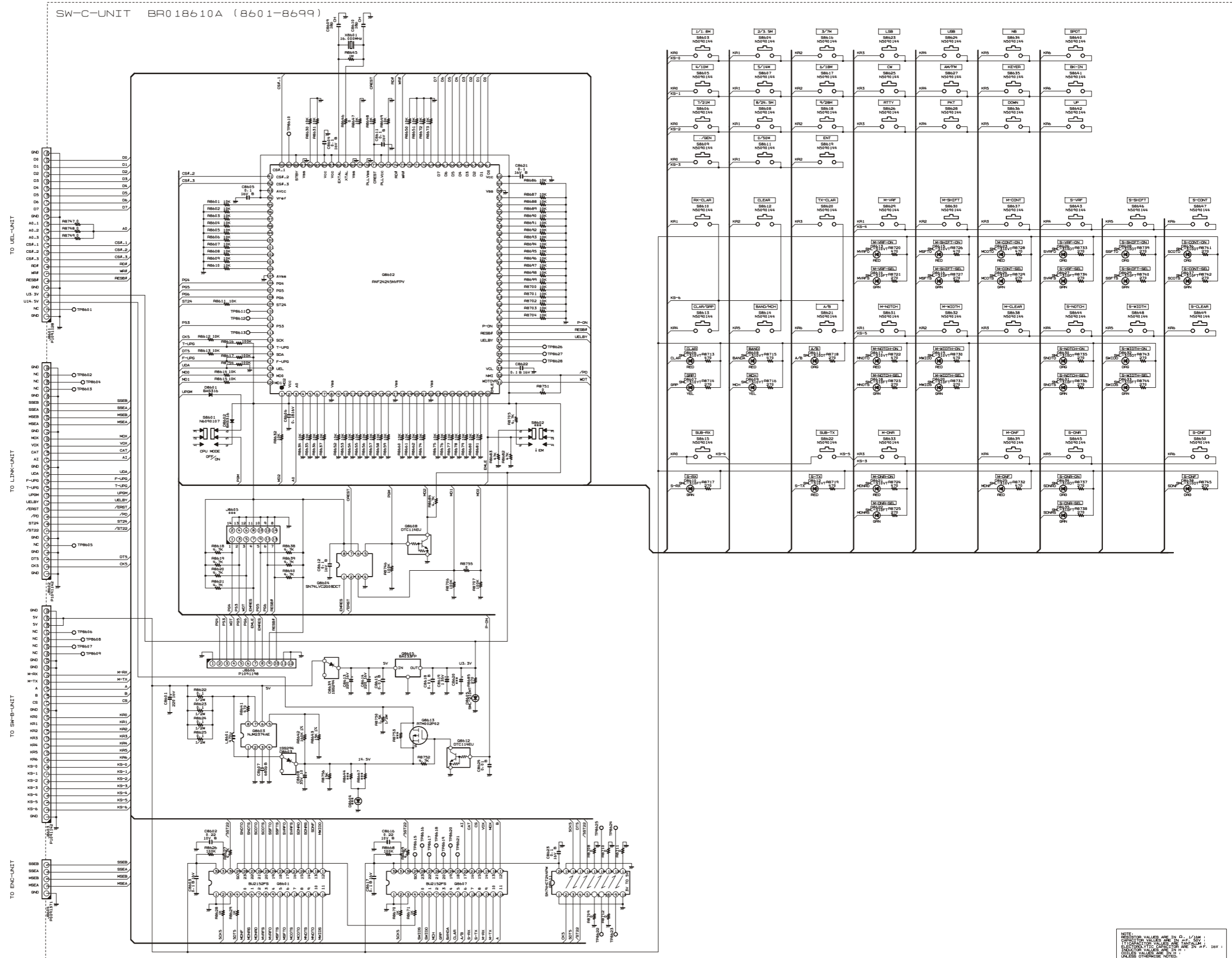

NOTE:
 PARTIAL VALUES ARE IN Ω, 1/10W,
 1/10W, 1/2W, 1/4W, 1/2W, 1/2W,
 ELECTRICAL CHARACTERISTICS ARE IN P.F. 10V
 UNLESS OTHERWISE NOTED.

SW-C Unit

Note

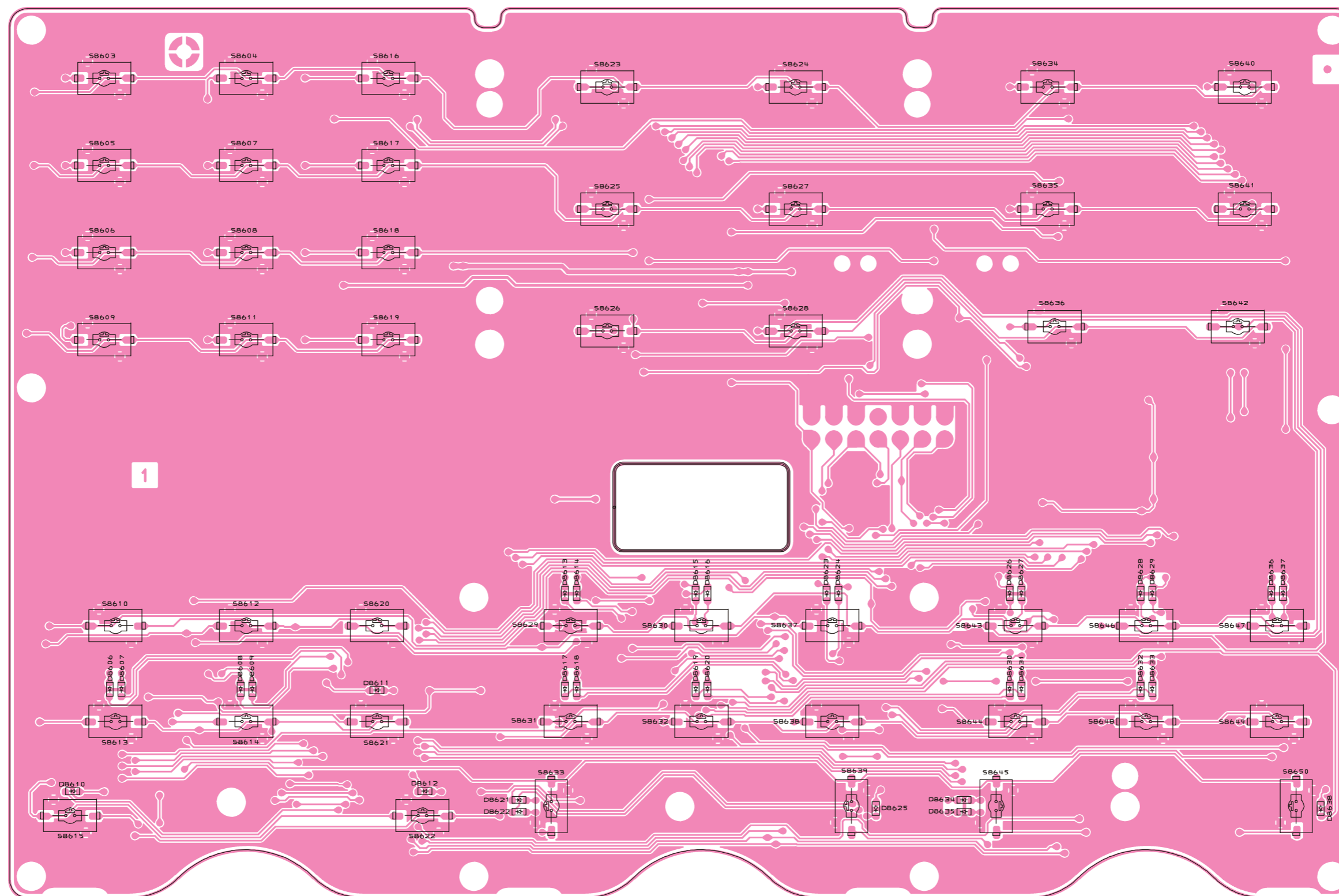

SW-C Unit

Parts Layout (Side B)

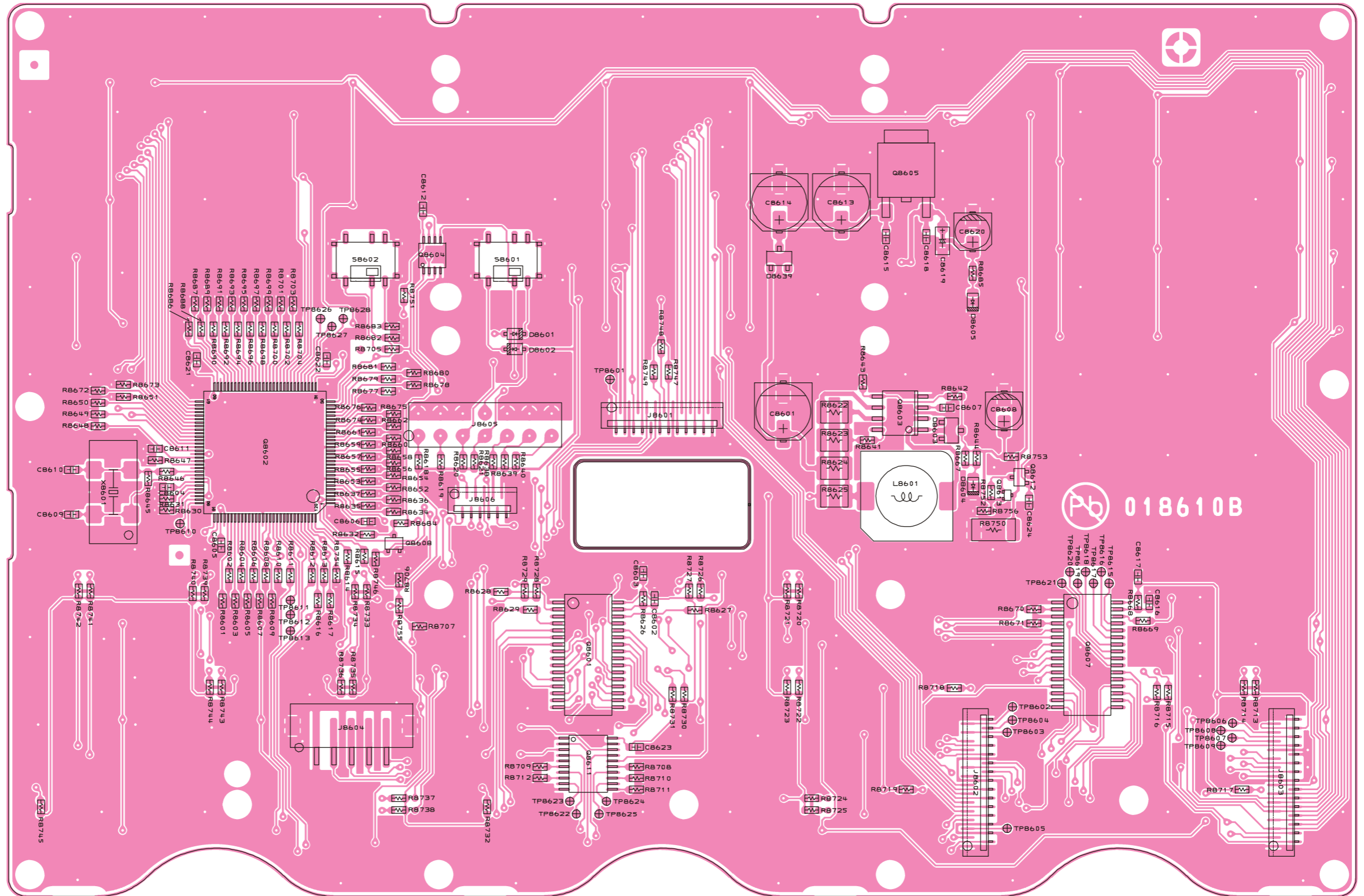

REF	DESCRIPTION	VALUE	V/W	TOL.	MFR'S DESIG	VXSTD P/N	VERS.	LOT	SIDE	LAY ADR
	PCB with Components					CS2084301				
	P.C.B. W/O COMP.					FR018610B		1-		
C 8601	AL.ELECTRO.CAP.	220uF	16V		EMVA160ADA221MF80G	K48120021		1-	B	e3
C 8602	CHIP CAP.	0.22uF	10V	B	GRM188B11A224KA01D	K22104801		1-	B	d4
C 8603	CHIP CAP.	0.1uF	16V	B	GRM188B11C104KA01D	K22124805		1-	B	d4
C 8604	CHIP CAP.	0.1uF	16V	B	GRM188B11C104KA01D	K22124805		1-	B	a3
C 8605	CHIP CAP.	0.1uF	16V	B	GRM188B11C104KA01D	K22124805		1-	B	b4
C 8606	CHIP CAP.	0.1uF	16V	B	GRM188B11C104KA01D	K22124805		1-	B	c3
C 8607	CHIP CAP.	680pF	50V	B	GRM188B11H681KA01D	K22174807		1-	B	f3
C 8608	AL.ELECTRO.CAP.	10uF	35V		EEE1VA100WR	K48160006		1-	B	f3
C 8609	CHIP CAP.	18pF	50V	CH	GRM1882C1H180JA01D	K22174217		1-	B	a3
C 8610	CHIP CAP.	18pF	50V	CH	GRM1882C1H180JA01D	K22174217		1-	B	a3
C 8611	CHIP CAP.	0.1uF	16V	B	GRM188B11C104KA01D	K22124805		1-	B	a3
C 8612	CHIP CAP.	0.1uF	16V	B	GRM188B11C104KA01D	K22124805		1-	B	c2
C 8613	AL.ELECTRO.CAP.	220uF	16V		EMVA160ADA221MF80G	K48120021		1-	B	e2
C 8614	AL.ELECTRO.CAP.	220uF	16V		EMVA160ADA221MF80G	K48120021		1-	B	e2
C 8615	CHIP CAP.	0.01uF	50V	B	GRM188B11H103KA01D	K22174823		1-	B	f2
C 8616	CHIP CAP.	0.22uF	10V	B	GRM188B11A224KA01D	K22104801		1-	B	g4
C 8617	CHIP CAP.	0.1uF	16V	B	GRM188B11C104KA01D	K22124805		1-	B	g4
C 8618	CHIP CAP.	0.01uF	50V	B	GRM188B11H103KA01D	K22174823		1-	B	f2
C 8619	CHIP TA.CAP.	1uF	35V		TEESVA1V105M8R	K78160032		1-	B	f2
C 8621	CHIP CAP.	0.1uF	16V	B	GRM188B11C104KA01D	K22124805		1-	B	b3
C 8622	CHIP CAP.	0.1uF	16V	B	GRM188B11C104KA01D	K22124805		1-	B	b3
C 8623	CHIP CAP.	0.1uF	16V	B	GRM188B11C104KA01D	K22124805		1-	B	d5
C 8624	CHIP CAP.	0.01uF	50V	B	GRM188B11H103KA01D	K22174823		1-	B	f3
D 8601	DIODE				BAS316	G2070716		1-	B	c2
D 8602	DIODE				BAS316	G2070716		1-	B	c2
D 8603	DIODE				1SS294(TE85R.F)	G2070058		1-	B	f3
D 8605	LED				SML-210MTT86	G2070524		1-	B	f2
D 8606	LED				SML-310VTT86JK	G2071032		1-	A	A4
D 8607	LED				SML-310YTT86KL	G2071034		1-	A	A4
D 8608	LED				SML-310VTT86JK	G2071032		1-	A	B4
D 8609	LED				SML-310YTT86KL	G2071034		1-	A	B4
D 8610	LED				SML-310FTT86KL	G2071026		1-	A	A5
D 8611	LED				SML-310DTT86KL	G2071024		1-	A	C4
D 8612	LED				SML-310VTT86JK	G2071032		1-	A	C5
D 8613	LED				SML-310VTT86JK	G2071032		1-	A	D4
D 8614	LED				SML-310FTT86KL	G2071026		1-10	A	D4
D 8615	LED				SML-310VTT86JK	G2071032		1-	A	D4
D 8616	LED				SML-310FTT86KL	G2071026		1-10	A	E4
D 8617	LED				SML-310VTT86JK	G2071032		1-	A	D4
D 8618	LED				SML-310FTT86KL	G2071026		1-10	A	D4
D 8619	LED				SML-310VTT86JK	G2071032		1-	A	D4
D 8620	LED				SML-310FTT86KL	G2071026		1-10	A	E4
D 8621	LED				SML-310VTT86JK	G2071032		1-	A	C5
D 8622	LED				SML-310FTT86KL	G2071026		1-10	A	C5
D 8623	LED				SML-310VTT86JK	G2071032		1-	A	E4
D 8624	LED				SML-310FTT86KL	G2071026		1-10	A	E4
D 8625	LED				SML-310VTT86JK	G2071032		1-	A	E5
D 8626	LED				SML-310DTT86KL	G2071024		1-	A	F4
D 8627	LED				SML-310FTT86KL	G2071026		1-10	A	F4
D 8628	LED				SML-310DTT86KL	G2071024		1-	A	G4
D 8629	LED				SML-310FTT86KL	G2071026		1-10	A	G4
D 8630	LED				SML-310DTT86KL	G2071024		1-	A	F4
D 8631	LED				SML-310FTT86KL	G2071026		1-10	A	F4
D 8632	LED				SML-310DTT86KL	G2071024		1-	A	G4
D 8633	LED				SML-310FTT86KL	G2071026		1-10	A	G4
D 8634	LED				SML-310DTT86KL	G2071024		1-	A	F5
D 8635	LED				SML-310FTT86KL	G2071026		1-10	A	F5
D 8636	LED				SML-310DTT86KL	G2071024		1-	A	H4
D 8637	LED				SML-310FTT86KL	G2071026		1-10	A	H4
D 8638	LED				SML-310DTT86KL	G2071024		1-	A	H5
D 8639	DIODE				1SS294(TE85R.F)	G2070058		1-	B	e2
J 8601	CONNECTOR				24FLT-SM2-TB(LF)(SN)(M)	P1091128		1-	B	d3
J 8602	CONNECTOR				30FLT-SM2-TB(LF)(SN)(M)	P1091142		1-	B	f5
J 8603	CONNECTOR				30FLT-SM2-TB(LF)(SN)(M)	P1091142		1-	B	h5
J 8604	CONNECTOR				B5B-PH-SM4-TBT(LF)(SN)	P0091371		1-	B	b5
J 8606	CONNECTOR				12FLT-SM2-TB(LF)(SN)	P1091198		1-	B	c3
L 8601	M.RFC	470uH			CDRH105RNP-471NC-VS	L1691359		1-	B	f3
Q 8601	IC				BU2152FS(TAPE)	G1093942		1-	B	d4
Q 8602	IC				R4F24245NVFPV	G1094723		1-	B	b3
Q 8603	IC				NJM2374AE-TE1	G1093808		1-	B	f3
Q 8604	IC				SN74LVC2G08DCTR	G1094341		1-	B	c2

SW-C Unit

Parts List

REF	DESCRIPTION	VALUE	V/W	TOL.	MFR'S DESIG	VXSTD P/N	VERS.	LOT	SIDE	LAY ADR
Q 8605	IC				BA033CC0FP-E2	G1094077		1-	B	f1
Q 8607	IC				BU2152FS(TAPE)	G1093942		1-	B	g4
Q 8608	TRANSISTOR				DTC114EUA T106	G3070084		1-	B	c4
Q 8611	IC				SN74HCT244PWR	G1094091		1-	B	d5
Q 8612	TRANSISTOR				DTC114EUA T106	G3070084		1-	B	f3
Q 8613	FET				RTM002P02(TAPE)	G3070347		1-	B	f3
R 8601	CHIP RES.	10k	1/16W	5%	RMC1/16 103JATP	J24185103		1-	B	b4
R 8602	CHIP RES.	10k	1/16W	5%	RMC1/16 103JATP	J24185103		1-	B	b4
R 8603	CHIP RES.	10k	1/16W	5%	RMC1/16 103JATP	J24185103		1-	B	b4
R 8604	CHIP RES.	10k	1/16W	5%	RMC1/16 103JATP	J24185103		1-	B	b4
R 8605	CHIP RES.	10k	1/16W	5%	RMC1/16 103JATP	J24185103		1-	B	b4
R 8606	CHIP RES.	10k	1/16W	5%	RMC1/16 103JATP	J24185103		1-	B	b4
R 8607	CHIP RES.	10k	1/16W	5%	RMC1/16 103JATP	J24185103		1-	B	b4
R 8608	CHIP RES.	10k	1/16W	5%	RMC1/16 103JATP	J24185103		1-	B	b4
R 8609	CHIP RES.	10k	1/16W	5%	RMC1/16 103JATP	J24185103		1-	B	b4
R 8610	CHIP RES.	10k	1/16W	5%	RMC1/16 103JATP	J24185103		1-	B	b4
R 8611	CHIP RES.	10k	1/16W	5%	RMC1/16 103JATP	J24185103		1-	B	b4
R 8612	CHIP RES.	10k	1/16W	5%	RMC1/16 103JATP	J24185103		1-	B	b4
R 8613	CHIP RES.	10k	1/16W	5%	RMC1/16 103JATP	J24185103		1-	B	b4
R 8614	CHIP RES.	10k	1/16W	5%	RMC1/16 103JATP	J24185103		1-	B	b4
R 8615	CHIP RES.	10k	1/16W	5%	RMC1/16 103JATP	J24185103		1-	B	c4
R 8616	CHIP RES.	100k	1/16W	5%	RMC1/16 104JATP	J24185104		1-	B	b4
R 8617	CHIP RES.	100k	1/16W	5%	RMC1/16 104JATP	J24185104		1-	B	b4
R 8618	CHIP RES.	4.7k	1/16W	5%	RMC1/16 472JATP	J24185472		1-	B	c3
R 8619	CHIP RES.	4.7k	1/16W	5%	RMC1/16 472JATP	J24185472		1-	B	c3
R 8620	CHIP RES.	4.7k	1/16W	5%	RMC1/16 472JATP	J24185472		1-	B	c3
R 8621	CHIP RES.	4.7k	1/16W	5%	RMC1/16 472JATP	J24185472		1-	B	c3
R 8622	CHIP RES.	0.1	1/2W	5%	RLC35 R100JTE	J24279030		1-	B	e3
R 8623	CHIP RES.	0.1	1/2W	5%	RLC35 R100JTE	J24279030		1-	B	e3
R 8624	CHIP RES.	0.1	1/2W	5%	RLC35 R100JTE	J24279030		1-	B	e3
R 8625	CHIP RES.	0.1	1/2W	5%	RLC35 R100JTE	J24279030		1-	B	e3
R 8626	CHIP RES.	100k	1/16W	5%	RMC1/16 104JATP	J24185104		1-	B	d4
R 8627	CHIP RES.	4.7k	1/16W	5%	RMC1/16 472JATP	J24185472		1-	B	d4
R 8628	CHIP RES.	1k	1/16W	5%	RMC1/16 102JATP	J24185102		1-	B	c4
R 8629	CHIP RES.	1k	1/16W	5%	RMC1/16 102JATP	J24185102		1-	B	c4
R 8630	CHIP RES.	10k	1/16W	5%	RMC1/16 103JATP	J24185103		1-	B	a3
R 8631	CHIP RES.	10k	1/16W	5%	RMC1/16 103JATP	J24185103		1-	B	a3
R 8632	CHIP RES.	10k	1/16W	5%	RMC1/16 103JATP	J24185103		1-	B	c4
R 8633	CHIP RES.	10k	1/16W	5%	RMC1/16 103JATP	J24185103		1-	B	c3
R 8634	CHIP RES.	10k	1/16W	5%	RMC1/16 103JATP	J24185103		1-	B	c3
R 8635	CHIP RES.	10k	1/16W	5%	RMC1/16 103JATP	J24185103		1-	B	c3
R 8636	CHIP RES.	10k	1/16W	5%	RMC1/16 103JATP	J24185103		1-	B	c3
R 8637	CHIP RES.	10k	1/16W	5%	RMC1/16 103JATP	J24185103		1-	B	c3
R 8638	CHIP RES.	4.7k	1/16W	5%	RMC1/16 472JATP	J24185472		1-	B	c3
R 8639	CHIP RES.	4.7k	1/16W	5%	RMC1/16 472JATP	J24185472		1-	B	c3
R 8640	CHIP RES.	4.7k	1/16W	5%	RMC1/16 472JATP	J24185472		1-	B	c3
R 8641	CHIP RES.	470	1/16W	5%	RMC1/16 471JATP	J24185471		1-	B	e3
R 8642	CHIP RES.	160k	1/16W	1%	RMC1/16 164FTP	J24183164		1-	B	f3
R 8643	CHIP RES.	15k	1/16W	1%	RMC1/16 153FTP	J24183153		1-	B	e3
R 8645	CHIP RES.	1M	1/16W	5%	RMC1/16 105JATP	J24185105		1-	B	a3
R 8646	CHIP RES.	0	1/16W	5%	RMC1/16 000JATP	J24185000		1-	B	a3
R 8647	CHIP RES.	10k	1/16W	5%	RMC1/16 103JATP	J24185103		1-	B	a3
R 8648	CHIP RES.	10k	1/16W	5%	RMC1/16 103JATP	J24185103		1-	B	a3
R 8649	CHIP RES.	10k	1/16W	5%	RMC1/16 103JATP	J24185103		1-	B	a3
R 8650	CHIP RES.	10k	1/16W	5%	RMC1/16 103JATP	J24185103		1-	B	a3
R 8651	CHIP RES.	10k	1/16W	5%	RMC1/16 103JATP	J24185103		1-	B	a3
R 8652	CHIP RES.	10k	1/16W	5%	RMC1/16 103JATP	J24185103		1-	B	c3
R 8653	CHIP RES.	10k	1/16W	5%	RMC1/16 103JATP	J24185103		1-	B	c3
R 8654	CHIP RES.	10k	1/16W	5%	RMC1/16 103JATP	J24185103		1-	B	c3
R 8655	CHIP RES.	10k	1/16W	5%	RMC1/16 103JATP	J24185103		1-	B	c3
R 8656	CHIP RES.	10k	1/16W	5%	RMC1/16 103JATP	J24185103		1-	B	c3
R 8657	CHIP RES.	10k	1/16W	5%	RMC1/16 103JATP	J24185103		1-	B	c3
R 8658	CHIP RES.	10k	1/16W	5%	RMC1/16 103JATP	J24185103		1-	B	c3
R 8659	CHIP RES.	10k	1/16W	5%	RMC1/16 103JATP	J24185103		1-	B	c3
R 8660	CHIP RES.	10k	1/16W	5%	RMC1/16 103JATP	J24185103		1-	B	c3
R 8661	CHIP RES.	10k	1/16W	5%	RMC1/16 103JATP	J24185103		1-	B	c3
R 8662	CHIP RES.	10k	1/16W	5%	RMC1/16 103JATP	J24185103		1-	B	c3
R 8668	CHIP RES.	100k	1/16W	5%	RMC1/16 104JATP	J24185104		1-	B	g4
R 8669	CHIP RES.	4.7k	1/16W	5%	RMC1/16 472JATP	J24185472		1-	B	g4
R 8670	CHIP RES.	1k	1/16W	5%	RMC1/16 102JATP	J24185102		1-	B	f4
R 8671	CHIP RES.	1k	1/16W	5%	RMC1/16 102JATP	J24185102		1-	B	f4
R 8672	CHIP RES.	10k	1/16W	5%	RMC1/16 103JATP	J24185103		1-	B	a3
R 8673	CHIP RES.	10k	1/16W	5%	RMC1/16 103JATP	J24185103		1-	B	a3
R 8674	CHIP RES.	10k	1/16W	5%	RMC1/16 103JATP	J24185103		1-	B	c3

SW-C Unit

Parts List

REF	DESCRIPTION	VALUE	V/W	TOL.	MFR'S DESIG	VXSTD P/N	VERS.	LOT	SIDE	LAY ADR
R 8675	CHIP RES.	10k	1/16W	5%	RMC1/16 103JATP	J24185103		1-	B	c3
R 8676	CHIP RES.	10k	1/16W	5%	RMC1/16 103JATP	J24185103		1-	B	c3
R 8677	CHIP RES.	10k	1/16W	5%	RMC1/16 103JATP	J24185103		1-	B	c3
R 8678	CHIP RES.	10k	1/16W	5%	RMC1/16 103JATP	J24185103		1-	B	c3
R 8679	CHIP RES.	10k	1/16W	5%	RMC1/16 103JATP	J24185103		1-	B	c3
R 8680	CHIP RES.	10k	1/16W	5%	RMC1/16 103JATP	J24185103		1-	B	c3
R 8681	CHIP RES.	10k	1/16W	5%	RMC1/16 103JATP	J24185103		1-	B	c3
R 8682	CHIP RES.	47k	1/16W	5%	RMC1/16 473JATP	J24185473		1-	B	c2
R 8683	CHIP RES.	47k	1/16W	5%	RMC1/16 473JATP	J24185473		1-	B	c2
R 8684	CHIP RES.	4.7k	1/16W	5%	RMC1/16 472JATP	J24185472		1-	B	c3
R 8685	CHIP RES.	270	1/16W	5%	RMC1/16 271JATP	J24185271		1-	B	f2
R 8686	CHIP RES.	10k	1/16W	5%	RMC1/16 103JATP	J24185103		1-	B	b2
R 8687	CHIP RES.	10k	1/16W	5%	RMC1/16 103JATP	J24185103		1-	B	b2
R 8688	CHIP RES.	10k	1/16W	5%	RMC1/16 103JATP	J24185103		1-	B	b2
R 8689	CHIP RES.	10k	1/16W	5%	RMC1/16 103JATP	J24185103		1-	B	b2
R 8690	CHIP RES.	10k	1/16W	5%	RMC1/16 103JATP	J24185103		1-	B	b2
R 8691	CHIP RES.	10k	1/16W	5%	RMC1/16 103JATP	J24185103		1-	B	b2
R 8692	CHIP RES.	10k	1/16W	5%	RMC1/16 103JATP	J24185103		1-	B	b2
R 8693	CHIP RES.	10k	1/16W	5%	RMC1/16 103JATP	J24185103		1-	B	b2
R 8694	CHIP RES.	10k	1/16W	5%	RMC1/16 103JATP	J24185103		1-	B	b2
R 8695	CHIP RES.	10k	1/16W	5%	RMC1/16 103JATP	J24185103		1-	B	b2
R 8696	CHIP RES.	10k	1/16W	5%	RMC1/16 103JATP	J24185103		1-	B	b2
R 8697	CHIP RES.	10k	1/16W	5%	RMC1/16 103JATP	J24185103		1-	B	b2
R 8698	CHIP RES.	10k	1/16W	5%	RMC1/16 103JATP	J24185103		1-	B	b2
R 8699	CHIP RES.	10k	1/16W	5%	RMC1/16 103JATP	J24185103		1-	B	b2
R 8700	CHIP RES.	10k	1/16W	5%	RMC1/16 103JATP	J24185103		1-	B	b2
R 8701	CHIP RES.	10k	1/16W	5%	RMC1/16 103JATP	J24185103		1-	B	b2
R 8702	CHIP RES.	10k	1/16W	5%	RMC1/16 103JATP	J24185103		1-	B	b2
R 8703	CHIP RES.	10k	1/16W	5%	RMC1/16 103JATP	J24185103		1-	B	b2
R 8704	CHIP RES.	10k	1/16W	5%	RMC1/16 103JATP	J24185103		1-	B	b2
R 8705	CHIP RES.	4.7k	1/16W	5%	RMC1/16 472JATP	J24185472		1-	B	c2
R 8706	CHIP RES.	100k	1/16W	5%	RMC1/16 104JATP	J24185104		1-	B	c4
R 8707	CHIP RES.	100k	1/16W	5%	RMC1/16 104JATP	J24185104		1-	B	c4
R 8708	CHIP RES.	0	1/16W	5%	RMC1/16 000JATP	J24185000		1-	B	d5
R 8709	CHIP RES.	0	1/16W	5%	RMC1/16 000JATP	J24185000		1-	B	d5
R 8710	CHIP RES.	0	1/16W	5%	RMC1/16 000JATP	J24185000		1-	B	d5
R 8711	CHIP RES.	0	1/16W	5%	RMC1/16 000JATP	J24185000		1-	B	d5
R 8712	CHIP RES.	0	1/16W	5%	RMC1/16 000JATP	J24185000		1-	B	d5
R 8713	CHIP RES.	470	1/16W	5%	RMC1/16 471JATP	J24185471		1-	B	h4
R 8714	CHIP RES.	270	1/16W	5%	RMC1/16 271JATP	J24185271		1-	B	h4
R 8715	CHIP RES.	470	1/16W	5%	RMC1/16 471JATP	J24185471		1-	B	g4
R 8716	CHIP RES.	270	1/16W	5%	RMC1/16 271JATP	J24185271		1-	B	g4
R 8717	CHIP RES.	270	1/16W	5%	RMC1/16 271JATP	J24185271		1-	B	h5
R 8718	CHIP RES.	270	1/16W	5%	RMC1/16 271JATP	J24185271		1-	B	f4
R 8719	CHIP RES.	470	1/16W	5%	RMC1/16 471JATP	J24185471		1-	B	f5
R 8720	CHIP RES.	470	1/16W	5%	RMC1/16 471JATP	J24185471		1-	B	e4
R 8721	CHIP RES.	270	1/16W	5%	RMC1/16 271JATP	J24185271		1-10	B	e4
R 8722	CHIP RES.	470	1/16W	5%	RMC1/16 471JATP	J24185471		1-	B	e4
R 8723	CHIP RES.	270	1/16W	5%	RMC1/16 271JATP	J24185271		1-10	B	e4
R 8724	CHIP RES.	470	1/16W	5%	RMC1/16 471JATP	J24185471		1-	B	e5
R 8725	CHIP RES.	270	1/16W	5%	RMC1/16 271JATP	J24185271		1-10	B	e5
R 8726	CHIP RES.	470	1/16W	5%	RMC1/16 471JATP	J24185471		1-	B	d4
R 8727	CHIP RES.	270	1/16W	5%	RMC1/16 271JATP	J24185271		1-10	B	d4
R 8728	CHIP RES.	470	1/16W	5%	RMC1/16 471JATP	J24185471		1-	B	d4
R 8729	CHIP RES.	270	1/16W	5%	RMC1/16 271JATP	J24185271		1-10	B	c4
R 8730	CHIP RES.	470	1/16W	5%	RMC1/16 471JATP	J24185471		1-	B	d4
R 8731	CHIP RES.	270	1/16W	5%	RMC1/16 271JATP	J24185271		1-10	B	d4
R 8732	CHIP RES.	470	1/16W	5%	RMC1/16 471JATP	J24185471		1-	B	c5
R 8733	CHIP RES.	270	1/16W	5%	RMC1/16 271JATP	J24185271		1-	B	c4
R 8734	CHIP RES.	270	1/16W	5%	RMC1/16 271JATP	J24185271		1-10	B	b4
R 8735	CHIP RES.	270	1/16W	5%	RMC1/16 271JATP	J24185271		1-	B	b4
R 8736	CHIP RES.	270	1/16W	5%	RMC1/16 271JATP	J24185271		1-10	B	b4
R 8737	CHIP RES.	270	1/16W	5%	RMC1/16 271JATP	J24185271		1-	B	c5
R 8738	CHIP RES.	270	1/16W	5%	RMC1/16 271JATP	J24185271		1-10	B	c5
R 8739	CHIP RES.	270	1/16W	5%	RMC1/16 271JATP	J24185271		1-	B	b4
R 8740	CHIP RES.	270	1/16W	5%	RMC1/16 271JATP	J24185271		1-10	B	b4
R 8741	CHIP RES.	270	1/16W	5%	RMC1/16 271JATP	J24185271		1-	B	a4
R 8742	CHIP RES.	270	1/16W	5%	RMC1/16 271JATP	J24185271		1-10	B	a4
R 8743	CHIP RES.	270	1/16W	5%	RMC1/16 271JATP	J24185271		1-	B	b4
R 8744	CHIP RES.	270	1/16W	5%	RMC1/16 271JATP	J24185271		1-10	B	b4
R 8745	CHIP RES.	270	1/16W	5%	RMC1/16 271JATP	J24185271		1-	B	a5
R 8746	CHIP RES.	100k	1/16W	5%	RMC1/16 104JATP	J24185104		1-	B	c4
R 8747	CHIP RES.	0	1/16W	5%	RMC1/16 000JATP	J24185000		1-	B	d3

SW-C Unit

Parts List

REF	DESCRIPTION	VALUE	V/W	TOL.	MFR'S DESIG	VXSTD P/N	VERS.	LOT	SIDE	LAY ADR
R 8748	CHIP RES.	0	1/16W	5%	RMC1/16 000JATP	J24185000		1-	B	d2
R 8749	CHIP RES.	0	1/16W	5%	RMC1/16 000JATP	J24185000		1-	B	d3
R 8750	CHIP RES.	1.5k	1/2W	5%	RMC1/2 152JCTP	J24275152		1-	B	f4
R 8751	CHIP RES.	0	1/16W	5%	RMC1/16 000JATP	J24185000		1-	B	c2
R 8752	CHIP RES.	4.7k	1/16W	5%	RMC1/16 472JATP	J24185472		1-	B	f3
R 8754	CHIP RES.	100k	1/16W	5%	RMC1/16 104JATP	J24185104		1-	B	b4
R 8755	CHIP RES.	0	1/16W	5%	RMC1/16 000JATP	J24185000		1-	B	c4
R 8756	CHIP RES.	15k	1/16W	5%	RMC1/16 153JATP	J24185153		1-	B	f3
S 8601	SLIDE SWITCH				SSSS820201	N6090107		1-	B	c2
S 8603	TACT SWITCH				SKQYPAE010	N5090144		1-	A	A1
S 8604	TACT SWITCH				SKQYPAE010	N5090144		1-	A	B1
S 8605	TACT SWITCH				SKQYPAE010	N5090144		1-	A	A1
S 8606	TACT SWITCH				SKQYPAE010	N5090144		1-	A	A2
S 8607	TACT SWITCH				SKQYPAE010	N5090144		1-	A	B1
S 8608	TACT SWITCH				SKQYPAE010	N5090144		1-	A	B2
S 8609	TACT SWITCH				SKQYPAE010	N5090144		1-	A	A2
S 8610	TACT SWITCH				SKQYPAE010	N5090144		1-	A	A4
S 8611	TACT SWITCH				SKQYPAE010	N5090144		1-	A	B2
S 8612	TACT SWITCH				SKQYPAE010	N5090144		1-	A	B4
S 8613	TACT SWITCH				SKQYPAE010	N5090144		1-	A	A5
S 8614	TACT SWITCH				SKQYPAE010	N5090144		1-	A	B5
S 8615	TACT SWITCH				SKQYPAE010	N5090144		1-	A	A5
S 8616	TACT SWITCH				SKQYPAE010	N5090144		1-	A	C1
S 8617	TACT SWITCH				SKQYPAE010	N5090144		1-	A	C1
S 8618	TACT SWITCH				SKQYPAE010	N5090144		1-	A	C2
S 8619	TACT SWITCH				SKQYPAE010	N5090144		1-	A	C2
S 8620	TACT SWITCH				SKQYPAE010	N5090144		1-	A	C4
S 8621	TACT SWITCH				SKQYPAE010	N5090144		1-	A	C5
S 8622	TACT SWITCH				SKQYPAE010	N5090144		1-	A	C5
S 8623	TACT SWITCH				SKQYPAE010	N5090144		1-	A	D1
S 8624	TACT SWITCH				SKQYPAE010	N5090144		1-	A	E1
S 8625	TACT SWITCH				SKQYPAE010	N5090144		1-	A	D2
S 8626	TACT SWITCH				SKQYPAE010	N5090144		1-	A	D2
S 8627	TACT SWITCH				SKQYPAE010	N5090144		1-	A	E2
S 8628	TACT SWITCH				SKQYPAE010	N5090144		1-	A	E2
S 8629	TACT SWITCH				SKQYPAE010	N5090144		1-	A	D4
S 8630	TACT SWITCH				SKQYPAE010	N5090144		1-	A	D4
S 8631	TACT SWITCH				SKQYPAE010	N5090144		1-	A	D5
S 8632	TACT SWITCH				SKQYPAE010	N5090144		1-	A	D5
S 8633	TACT SWITCH				SKQYPAE010	N5090144		1-	A	D5
S 8634	TACT SWITCH				SKQYPAE010	N5090144		1-	A	F1
S 8635	TACT SWITCH				SKQYPAE010	N5090144		1-	A	F2
S 8636	TACT SWITCH				SKQYPAE010	N5090144		1-	A	F2
S 8637	TACT SWITCH				SKQYPAE010	N5090144		1-	A	E4
S 8638	TACT SWITCH				SKQYPAE010	N5090144		1-	A	E5
S 8639	TACT SWITCH				SKQYPAE010	N5090144		1-	A	E5
S 8640	TACT SWITCH				SKQYPAE010	N5090144		1-	A	H1
S 8641	TACT SWITCH				SKQYPAE010	N5090144		1-	A	H2
S 8642	TACT SWITCH				SKQYPAE010	N5090144		1-	A	H2
S 8643	TACT SWITCH				SKQYPAE010	N5090144		1-	A	F4
S 8644	TACT SWITCH				SKQYPAE010	N5090144		1-	A	F5
S 8645	TACT SWITCH				SKQYPAE010	N5090144		1-	A	F5
S 8646	TACT SWITCH				SKQYPAE010	N5090144		1-	A	G4
S 8647	TACT SWITCH				SKQYPAE010	N5090144		1-	A	H4
S 8648	TACT SWITCH				SKQYPAE010	N5090144		1-	A	G5
S 8649	TACT SWITCH				SKQYPAE010	N5090144		1-	A	H5
S 8650	TACT SWITCH				SKQYPAE010	N5090144		1-	A	H5
X 8601	XTAL 92SMX(CN)	16MHz			16.000MHZ	H0103322		1-	B	a3

SW-D-UNIT BR0 18620B (8771-8799)

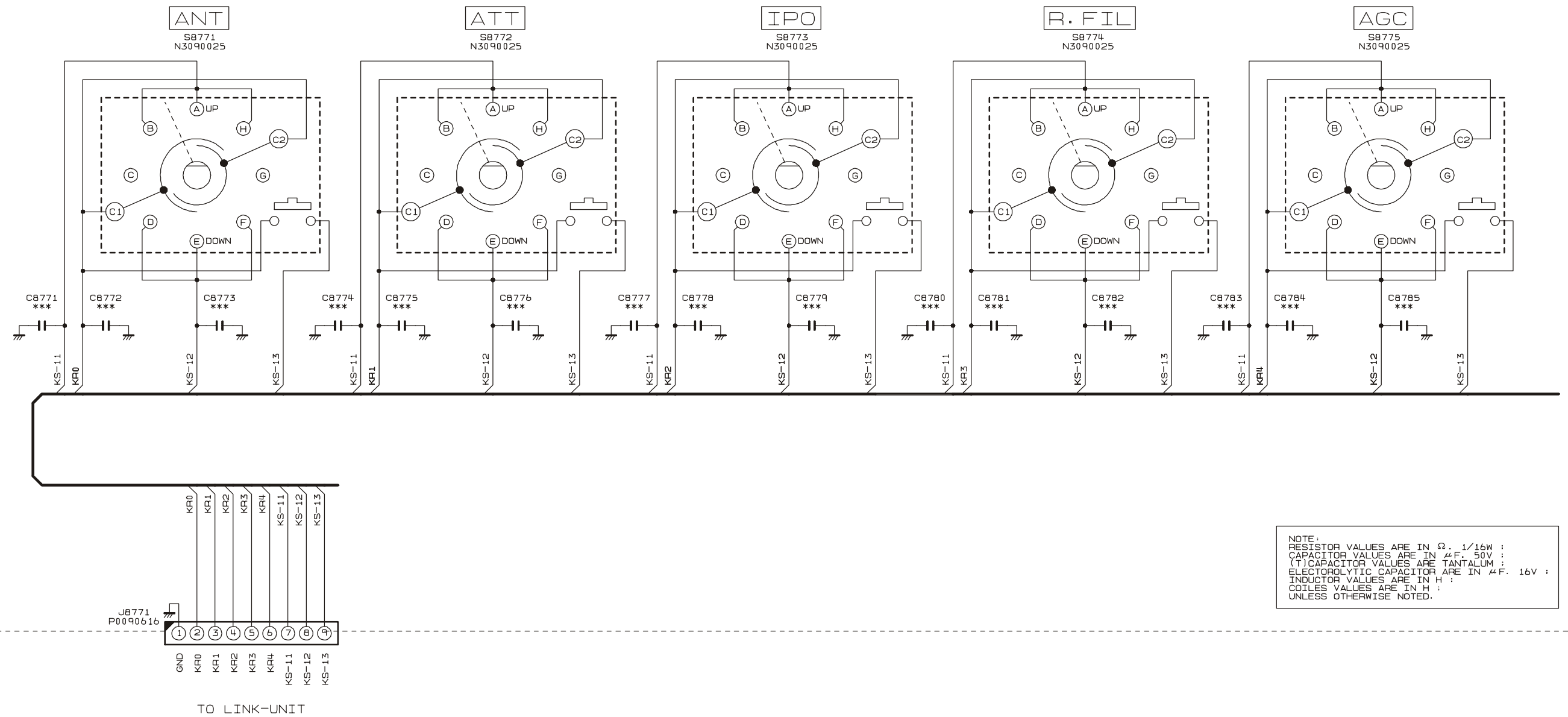

SW-D Unit

Parts Layout

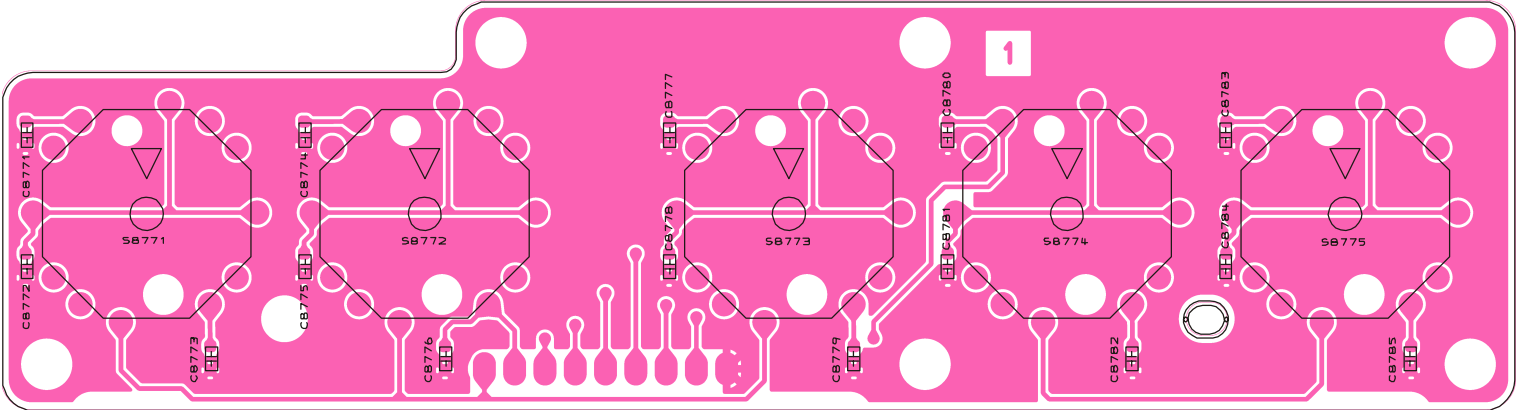

(Side A)

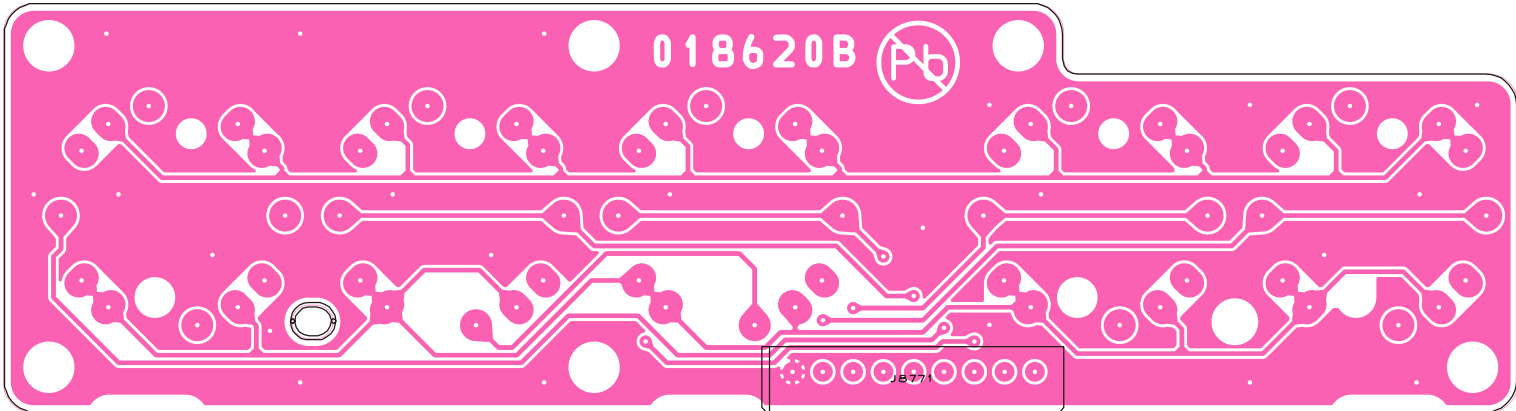

(Side B)

SW-D Unit

Note:

JACK Unit

Circuit Diagram

JACK-UNIT BR0 18630C (8801-8849)

NOTE:
 RESISTOR VALUES ARE IN Ω . 1/16W ;
 CAPACITOR VALUES ARE IN μ F. 50V ;
 (T)CAPACITOR VALUES ARE TANTALUM ;
 ELECTROLYTIC CAPACITOR ARE IN μ F. 16V ;
 INDUCTOR VALUES ARE IN H ;
 COILES VALUES ARE IN H ;
 UNLESS OTHERWISE NOTED.

PHONES

KEY

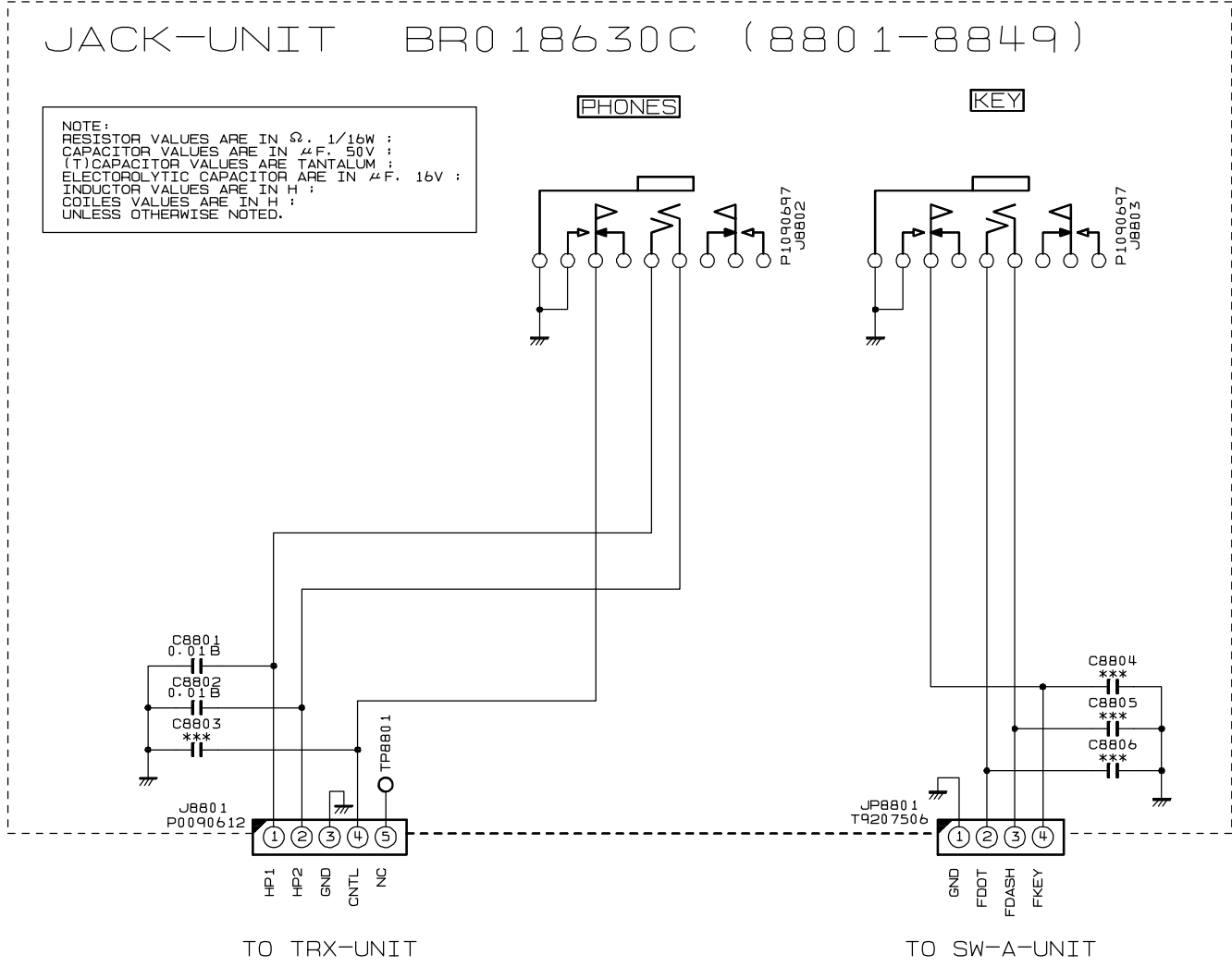

TO TRX-UNIT

TO SW-A-UNIT

JACK Unit

Parts Layout

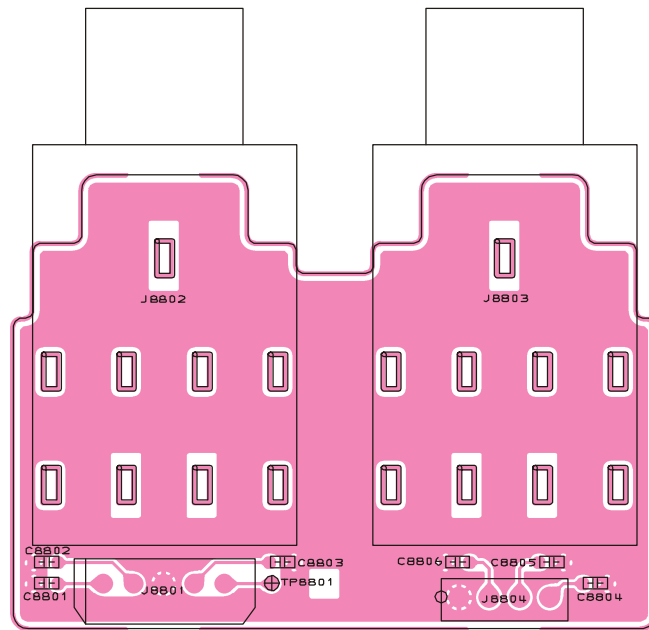

Side A

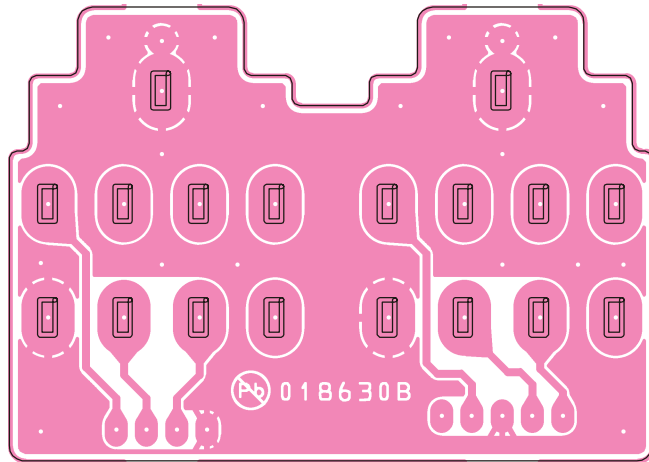

SideB

Parts List

REF	DESCRIPTION	VALUE	V/W	TOL.	MFR'S DESIG	VXSTD P/N	VERS.	LOT	SIDE	LAY ADR
	PCB with Components					CB4472001				
	P.C.B. W/O COMP.					FR018630B		1-		
C 8801	CHIP CAP.	0.01uF	50V	B	GRM188B11H103KA01D	K22174823		14-	A	
C 8802	CHIPCAP.	0.01uF	50V	B	GRM188B11H103KA01D	K22174823		14-	A	
J 8801	CONNECTOR				SB20-05WS	P0090612		1-	A	
J 8802	CONNECTOR				HLJ2305-0130609	P1090823		1-	A	
J 8803	CONNECTOR				HLJ2305-0130609	P1090823		1-	A	
JP8801	WIRE ASSY				AH036H 80MM4P	T9207506		1-		
	GROUND PLATE				(JACK)	RA1173300		1-		

MIC Unit Circuit Diagram

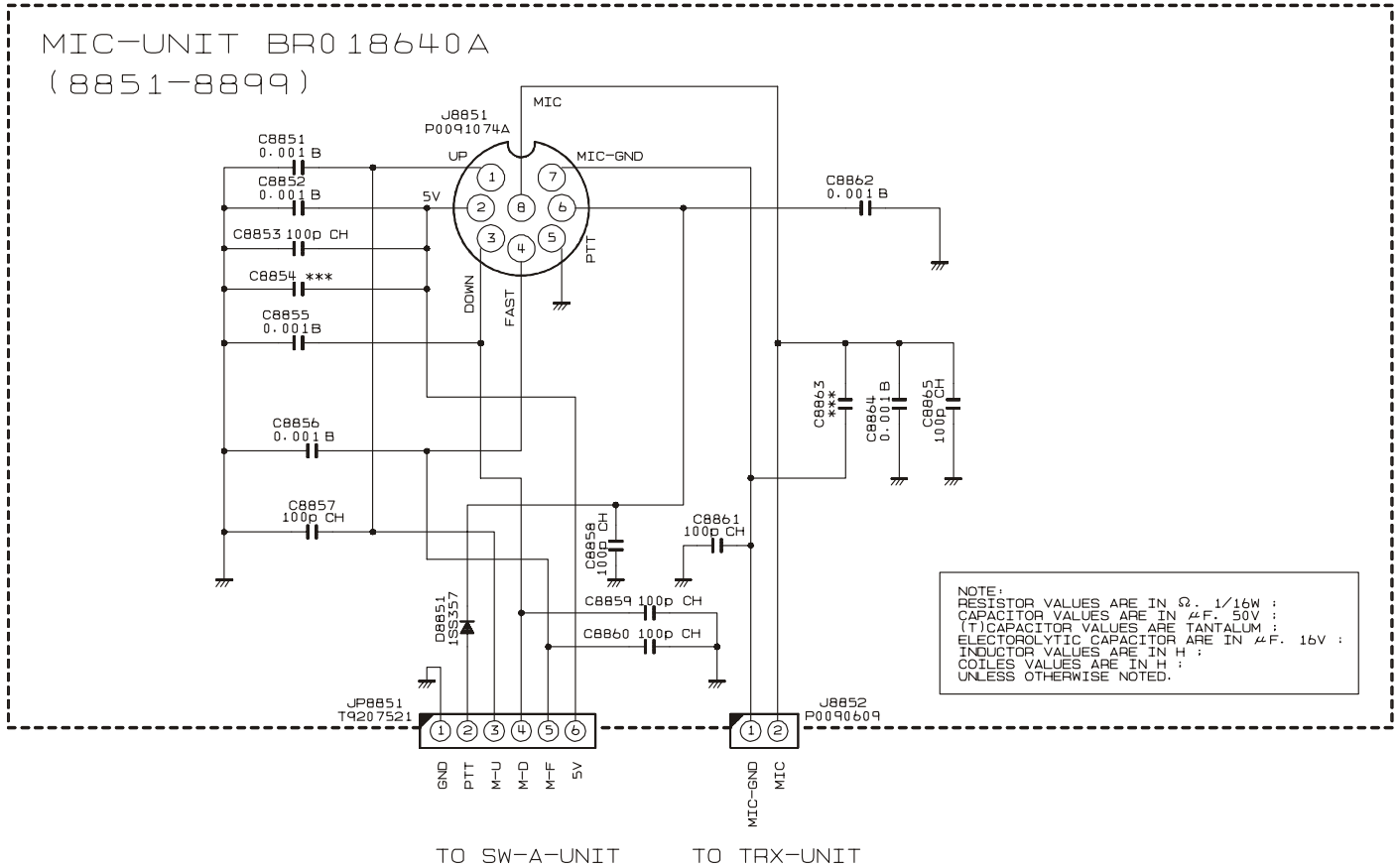

MIC Unit

Parts Layout

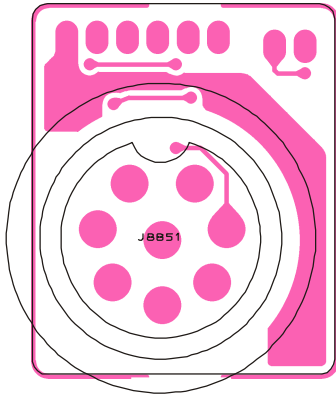

Side A

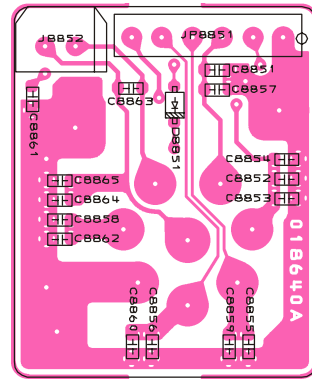

Side B

Parts List

REF	DESCRIPTION	VALUE	V/W	TOL.	MFR'S DESIG	VXSTD P/N	VERS.	LOT	SIDE	LAY ADR
	PCB with Components					CB4473001				
	Printed Circuit Board					FR018640A		1-		
C 8851	CHIP CAP.	0.001uF	50V	B	GRM188B11H102KA01D	K22174821		1-	B	
C 8852	CHIP CAP.	0.001uF	50V	B	GRM188B11H102KA01D	K22174821		1-	B	
C 8853	CHIP CAP.	100pF	50V	CH	GRM1882C1H101JA01D	K22174235		1-	B	
C 8855	CHIP CAP.	0.001uF	50V	B	GRM188B11H102KA01D	K22174821		1-	B	
C 8856	CHIP CAP.	0.001uF	50V	B	GRM188B11H102KA01D	K22174821		1-	B	
C 8857	CHIP CAP.	100pF	50V	CH	GRM1882C1H101JA01D	K22174235		1-	B	
C 8858	CHIP CAP.	100pF	50V	CH	GRM1882C1H101JA01D	K22174235		1-	B	
C 8859	CHIP CAP.	100pF	50V	CH	GRM1882C1H101JA01D	K22174235		1-	B	
C 8860	CHIP CAP.	100pF	50V	CH	GRM1882C1H101JA01D	K22174235		1-	B	
C 8861	CHIP CAP.	100pF	50V	CH	GRM1882C1H101JA01D	K22174235		1-	B	
C 8862	CHIP CAP.	0.001uF	50V	B	GRM188B11H102KA01D	K22174821		1-	B	
C 8864	CHIP CAP.	0.001uF	50V	B	GRM188B11H102KA01D	K22174821		1-	B	
C 8865	CHIP CAP.	100pF	50V	CH	GRM1882C1H101JA01D	K22174235		1-	B	
D 8851	DIODE				1SS357(TPH3.F)	G2070346		1-	B	
J 8851	CONNECTOR				FM214-8SMPT-NI	P0091074A		1-	A	
J 8852	CONNECTOR				SB20-02WS	P0090609		1-	B	
JP8851	WIRE ASSY				AH031H 90MM6P	T9207443		1	B	
JP8851	WIRE ASSY				AH036H 190MM6P	T9207521		2-	B	
	GROUND PLATE				(MIC)	RA1173200		1-		

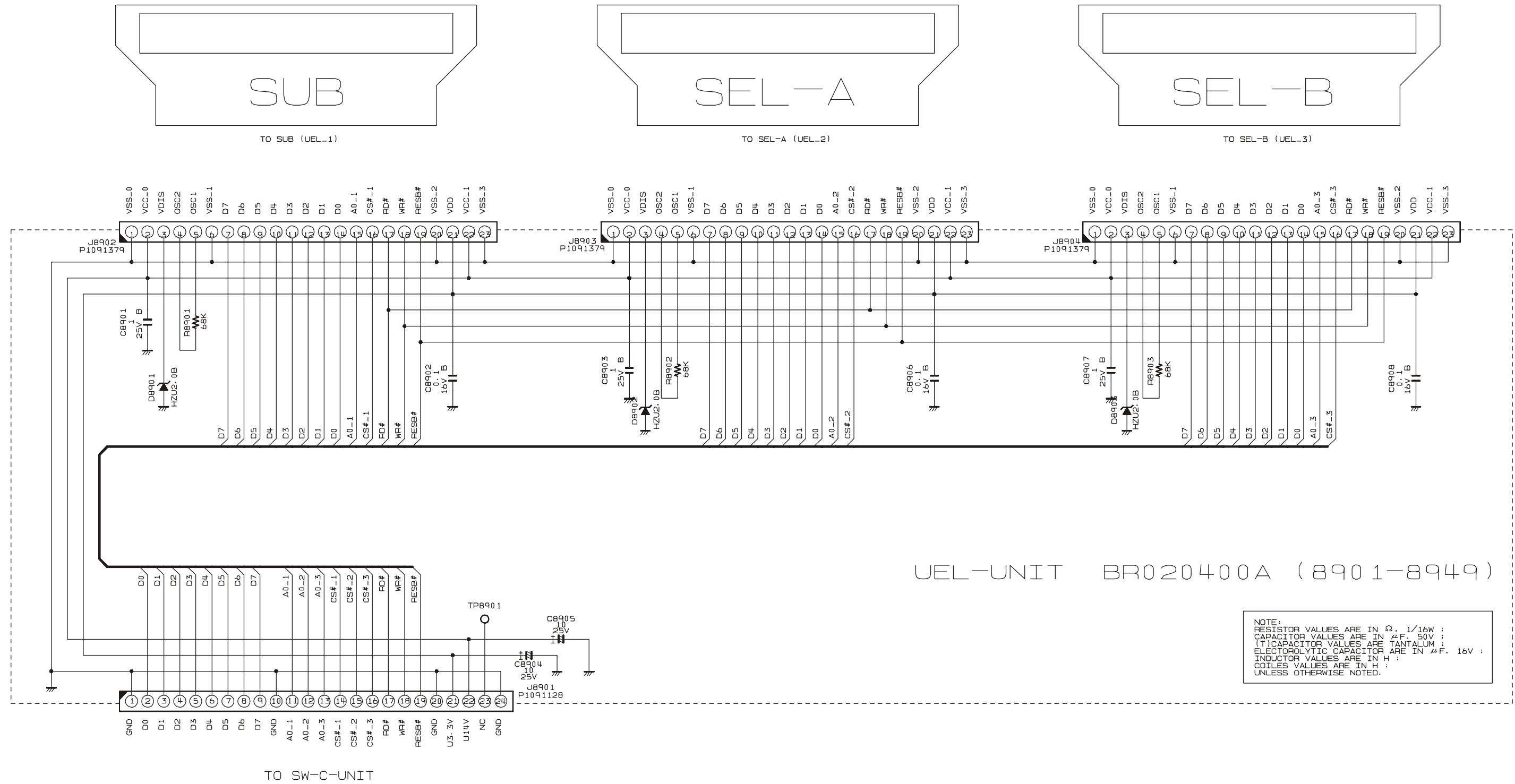

UEL-UNIT BR020400A (8901-8949)

NOTE:
 RESISTOR VALUES ARE IN Ω. 1/16W ;
 CAPACITOR VALUES ARE IN μF. 50V ;
 (T)CAPACITOR VALUES ARE TANTALUM ;
 ELECTROLYTIC CAPACITOR ARE IN μF. 16V ;
 INDUCTOR VALUES ARE IN H ;
 COILES VALUES ARE IN H ;
 UNLESS OTHERWISE NOTED.

UEL Unit

Parts Layout

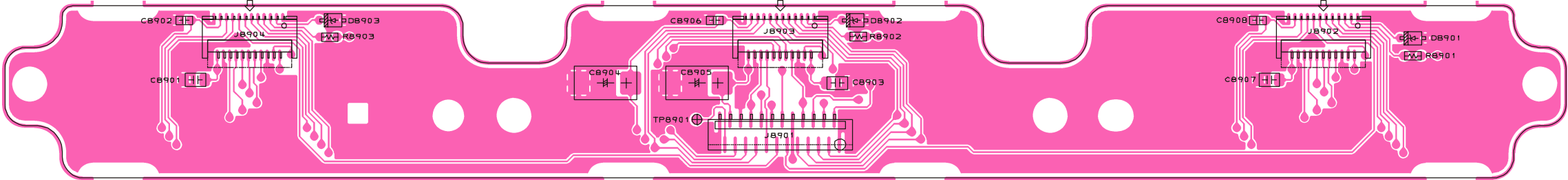

(Side A)

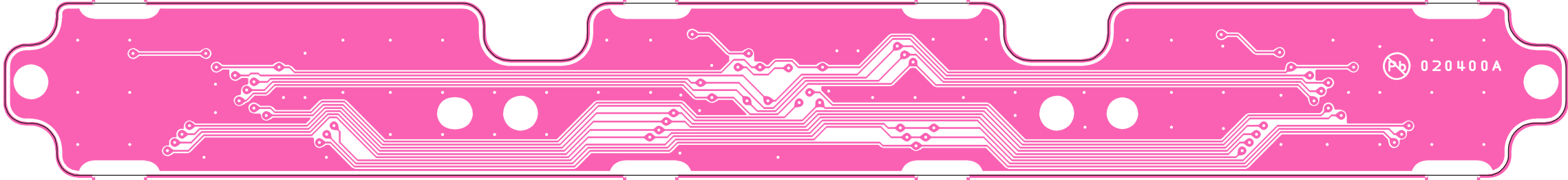

(Side B)

Parts List

REF	DESCRIPTION	VALUE	V/W	TOL.	MFR'S DESIG	VXSTD P/N	VERS.	LOT	SIDE	LAY ADR
	PCB with Components					CB4936001				
	Printed Circuit Board					FR020400A		1-		
C 8901	CHIP CAP.	1uF	25V	B	GRM21BB31E105KA98L	K22140826		1-	A	A1
C 8902	CHIP CAP.	0.1uF	16V	B	GRM188B11C104KA01D	K22124805		1-	A	A1
C 8903	CHIP CAP.	1uF	25V	B	GRM21BB31E105KA98L	K22140826		1-	A	E1
C 8904	CHIP TA.CAP.	10uF	25V		TEESVC1E106M12R	K78140021		1-	A	C1
C 8905	CHIP TA.CAP.	10uF	25V		TEESVC1E106M12R	K78140021		1-	A	D1
C 8906	CHIP CAP.	0.1uF	16V	B	GRM188B11C104KA01D	K22124805		1-	A	D1
C 8907	CHIP CAP.	1uF	25V	B	GRM21BB31E105KA98L	K22140826		1-	A	G1
C 8908	CHIP CAP.	0.1uF	16V	B	GRM188B11C104KA01D	K22124805		1-	A	G1
D 8901	DIODE				HZU2.0BTRF	G2070844		1-	A	G1
D 8902	DIODE				HZU2.0BTRF	G2070844		1-	A	E1
D 8903	DIODE				HZU2.0BTRF	G2070844		1-	A	B1
J 8901	CONNECTOR				24FLT-SM2-TB(LF)(SN)(M)	P1091128		1-	A	D1
J 8902	CONNECTOR				FF12-23A-R11B	P1091379		1-	A	G1
J 8903	CONNECTOR				FF12-23A-R11B	P1091379		1-	A	D1
J 8904	CONNECTOR				FF12-23A-R11B	P1091379		1-	A	B1
R 8901	CHIP RES.	68k	1/16W	5%	RMC1/16 683JATP	J24185683		1-	A	G1
R 8902	CHIP RES.	68k	1/16W	5%	RMC1/16 683JATP	J24185683		1-	A	E1
R 8903	CHIP RES.	68k	1/16W	5%	RMC1/16 683JATP	J24185683		1-	A	B1
	CAPTION TAPE				(5X10)	RA1209400		15-		

UEL Unit

Note:

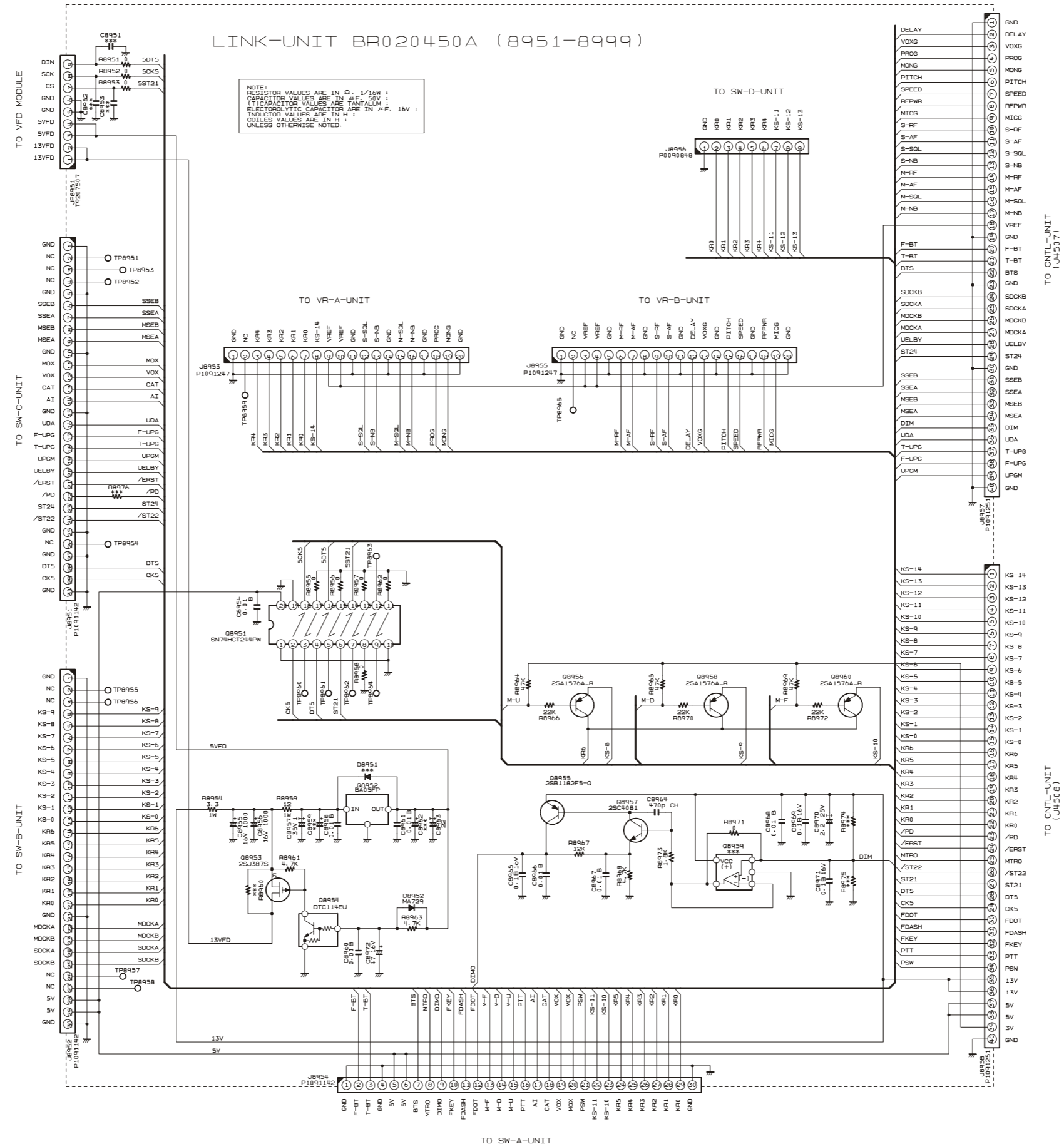

LINK Unit (Lot. 1)

Note

LINK Unit (Lot. 1)

Parts Layout (Side A)

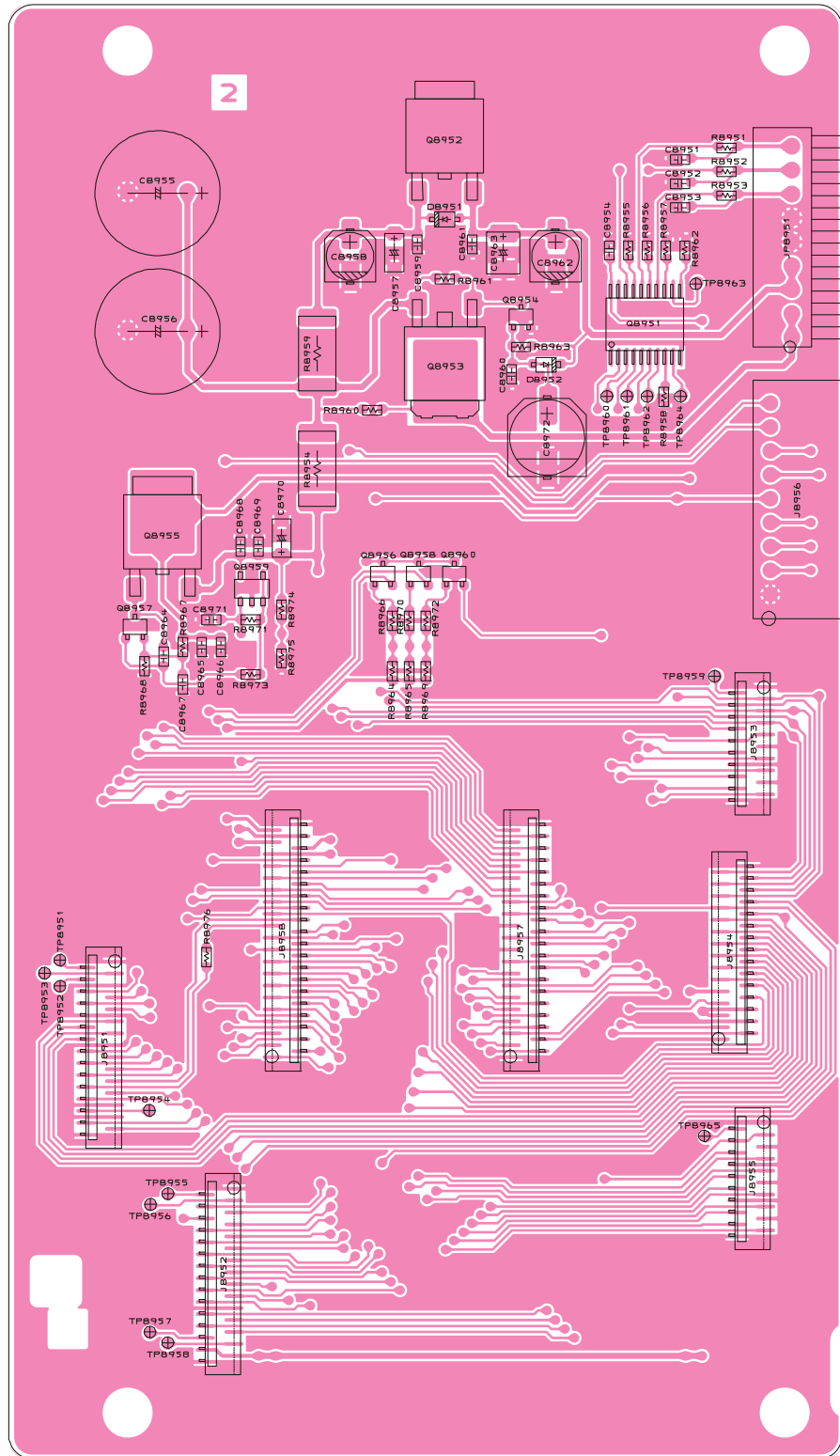

LINK Unit (Lot. 1)

Parts Layout (Side B)

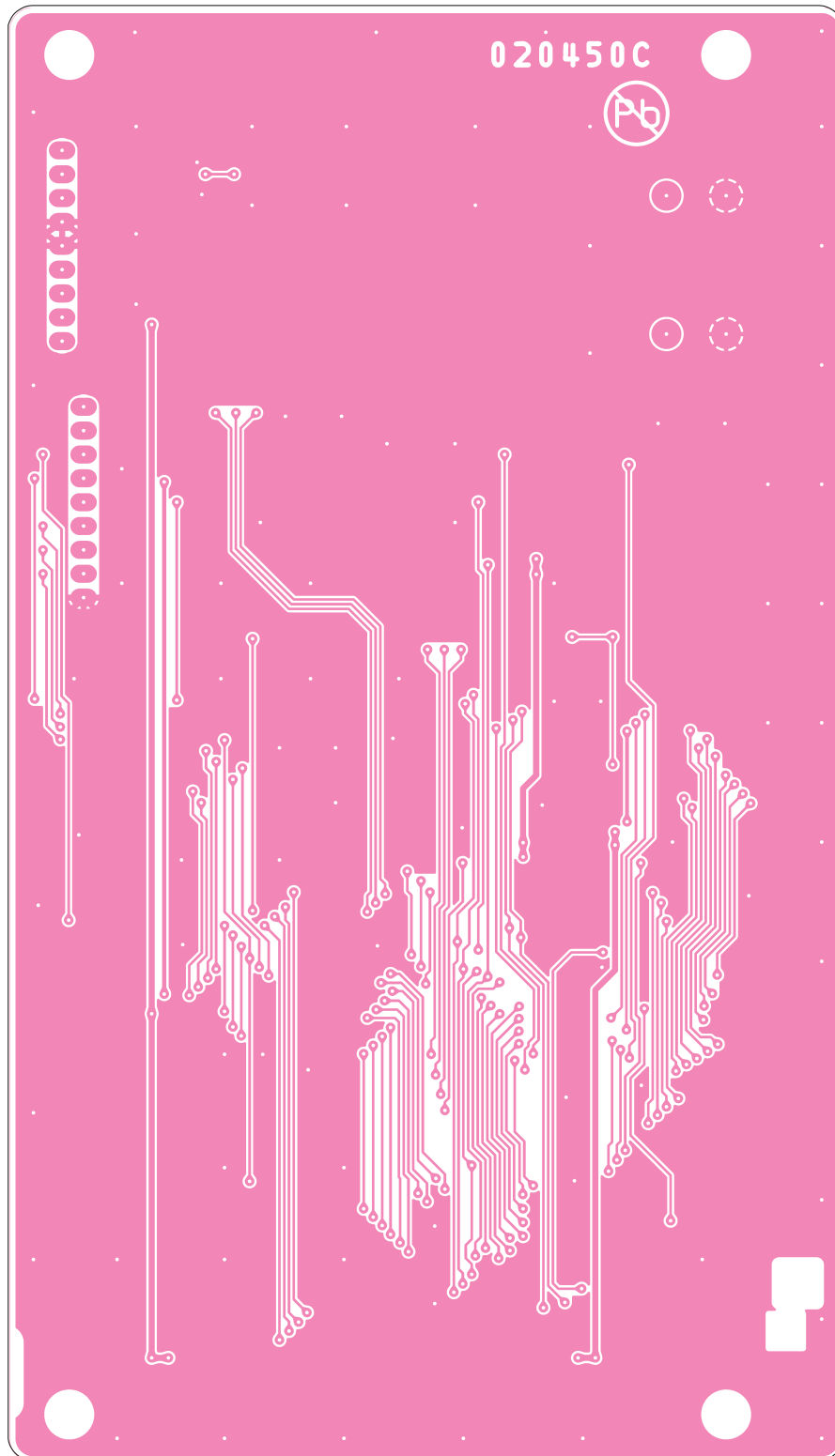

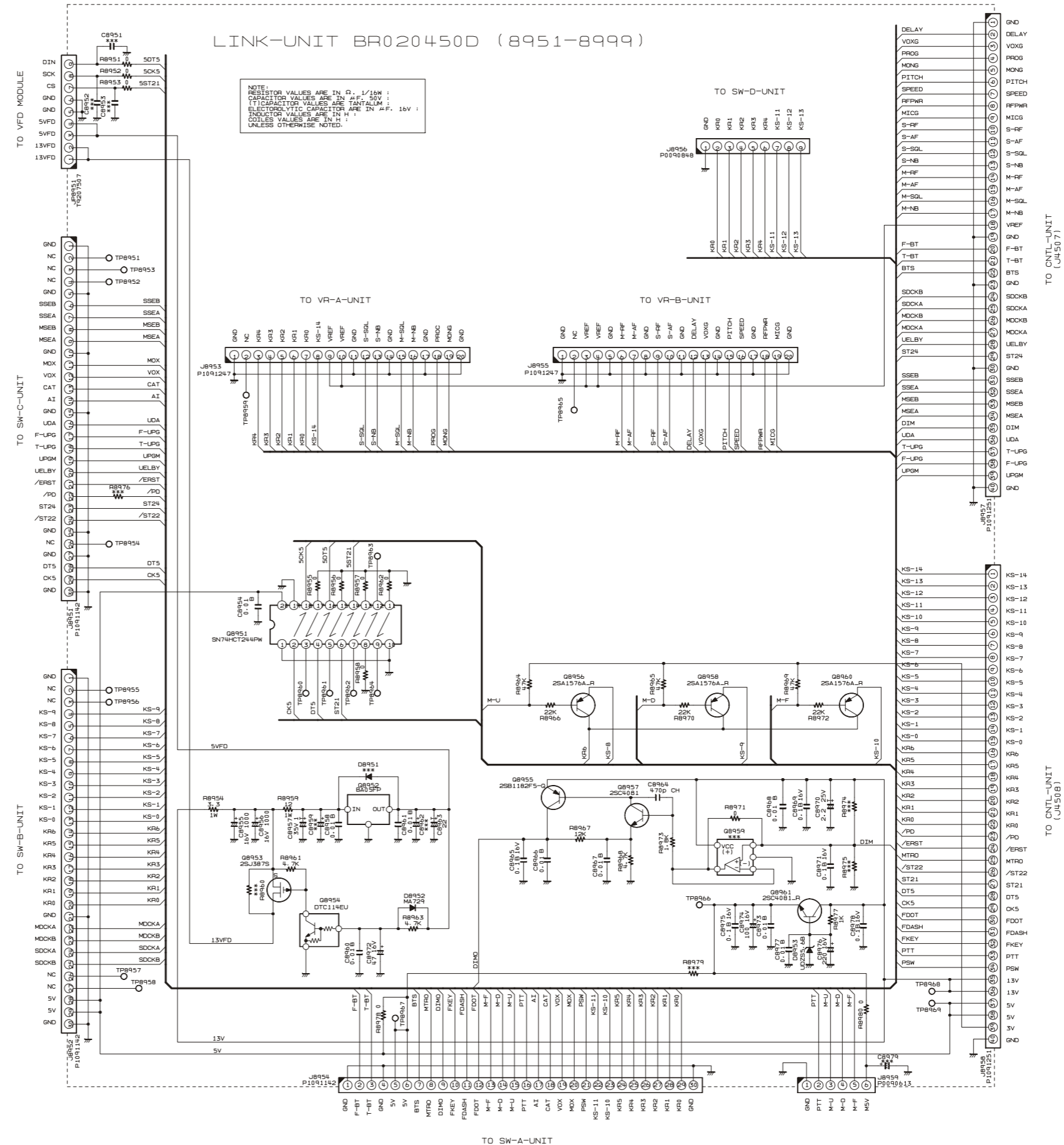

LINK Unit (Lot. 2~)

Note

LINK Unit (Lot. 2~)

Parts Layout (Side A)

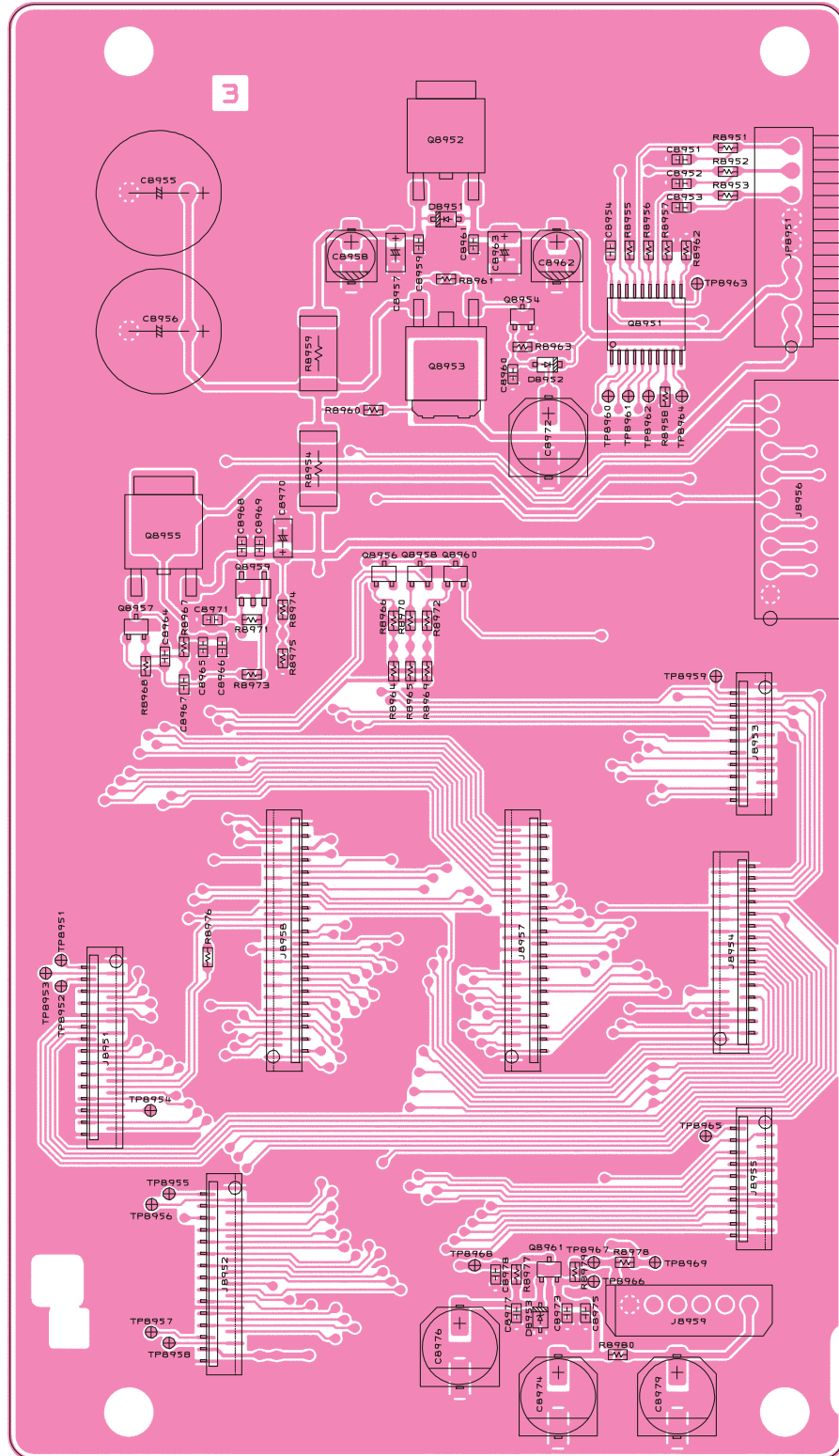

LINK Unit (Lot. 2~)

Parts Layout (Side B)

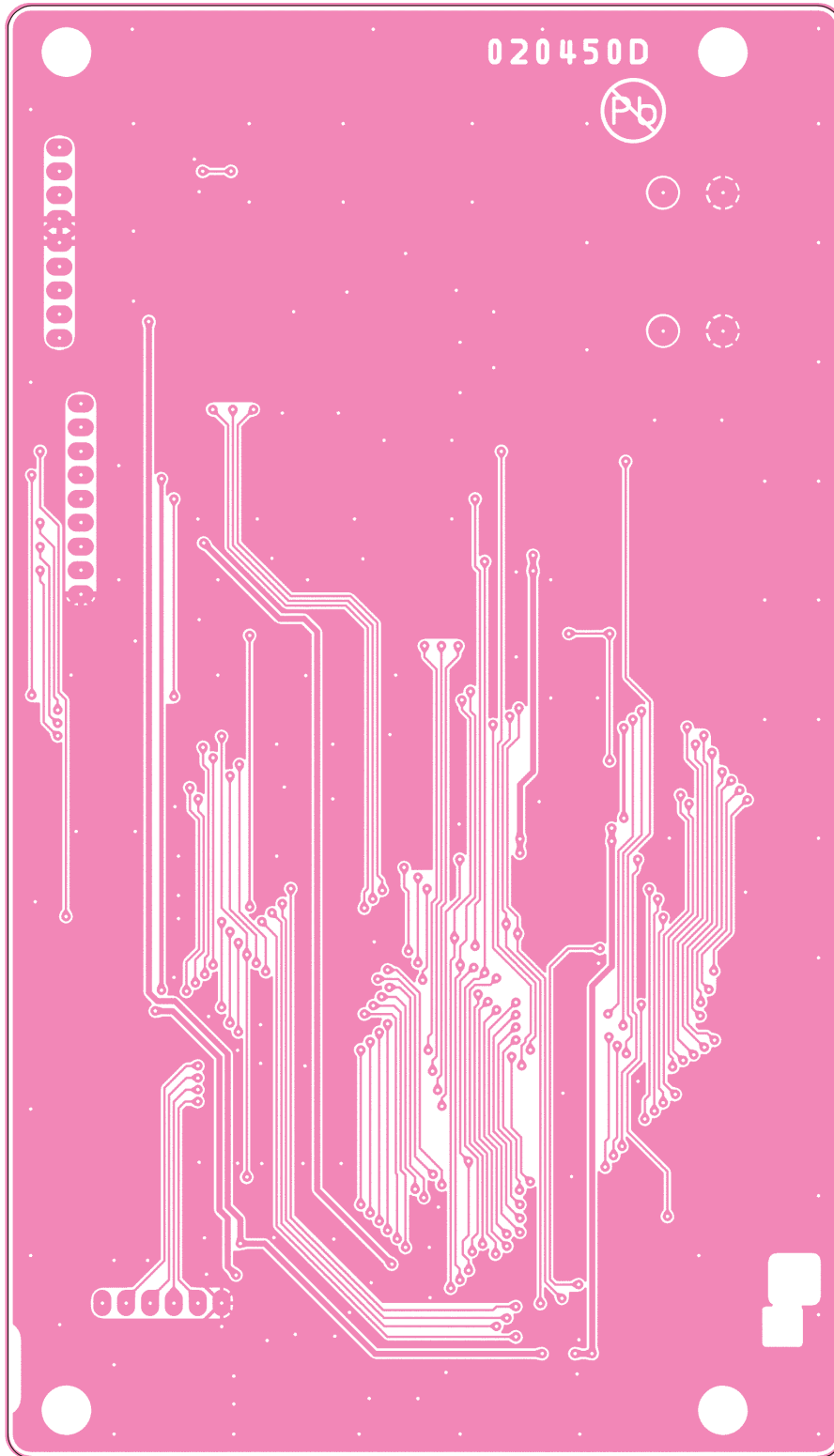

Parts List

REF	DESCRIPTION	VALUE	V/W	TOL.	MFR'S DESIG	VXSTD P/N	VERS.	LOT	SIDE	LAY ADR
	PCB with Components					CB4966001				
	Printed Circuit Board					FR020450C		1-		
	Printed Circuit Board					FR020450D		2-		
C 8954	CHIP CAP.	0.01uF	50V	B	GRM188B11H103KA01D	K22174823		1-	A	C2
C 8955	AL.ELECTRO.CAP.	1000uF	16V		RE3-16V102MH3#	K40129096		1-	A	A1
C 8956	AL.ELECTRO.CAP.	1000uF	16V		RE3-16V102MH3#	K40129096		1-	A	A2
C 8957	CHIP TA.CAP.	1uF	35V		TEESVA1V105M8R	K78160032		1-	A	B2
C 8959	CHIP CAP.	0.01uF	50V	B	GRM188B11H103KA01D	K22174823		1-	A	B2
C 8960	CHIP CAP.	0.01uF	50V	B	GRM188B11H103KA01D	K22174823		1-	A	C2
C 8961	CHIP CAP.	0.01uF	50V	B	GRM188B11H103KA01D	K22174823		1-	A	B2
C 8963	CHIP TA.CAP.	22uF			TPSB226M016Y0600	K78120075		1-	A	C2
C 8964	CHIP CAP.	470pF	50V	CH	GRM1882C1H471JA01D	K22174249		1-	A	A3
C 8965	CHIP CAP.	0.1uF	16V	B	GRM188B11C104KA01D	K22124805		1-	A	A3
C 8966	CHIP CAP.	0.01uF	50V	B	GRM188B11H103KA01D	K22174823		1-	A	A3
C 8967	CHIP CAP.	0.01uF	50V	B	GRM188B11H103KA01D	K22174823		1-	A	A3
C 8968	CHIP CAP.	0.01uF	50V	B	GRM188B11H103KA01D	K22174823		1-	A	A3
C 8969	CHIP CAP.	0.1uF	16V	B	GRM188B11C104KA01D	K22124805		1-	A	B3
C 8970	CHIP TA.CAP.	2.2uF	25V		TEESVA1E225M8R	K78140020		1-	A	B3
C 8971	CHIP CAP.	0.1uF	16V	B	GRM188B11C104KA01D	K22124805		1-	A	A3
C 8972	AL.ELECTRO.CAP.	47uF	16V		EEE1CA470SP	K48120005		1-	A	C2
C 8973	CHIP CAP.	0.01uF	50V	B	GRM188B11H103KA01D	K22174823		2-	A	C6
C 8974	AL.ELECTRO.CAP.	100uF	16V		EEE1CA101WP	K48120012		2-	A	C6
C 8975	CHIP CAP.	0.1uF	16V	B	GRM188B11C104KA01D	K22124805		2-	A	C6
C 8976	AL.ELECTRO.CAP.	220uF	16V		EMVA160ADA221MF80G	K48120021		2-	A	B6
C 8977	CHIP CAP.	0.01uF	50V	B	GRM188B11H103KA01D	K22174823		2-	A	C6
C 8978	CHIP CAP.	0.1uF	16V	B	GRM188B11C104KA01D	K22124805		2-	A	C6
D 8952	DIODE				MA729-(TX)	G2070320		1-	A	C2
D 8953	DIODE				UDZS TE-17 5.6B	G2070910		2-	A	C6
J 8951	CONNECTOR				30FLT-SM2-TB(LF)(SN)(M)	P1091142		1-	A	A5
J 8952	CONNECTOR				30FLT-SM2-TB(LF)(SN)(M)	P1091142		1-	A	A6
J 8953	CONNECTOR				20FLT-SM2-TB(LF)(SN)	P1091247		1-	A	D4
J 8954	CONNECTOR				30FLT-SM2-TB(LF)(SN)(M)	P1091142		1-	A	D4
J 8955	CONNECTOR				20FLT-SM2-TB(LF)(SN)	P1091247		1-	A	D5
J 8956	CONNECTOR				SB20-09WL	P0090848		1-	A	D3
J 8957	CONNECTOR				40FLT-SM2-TB(LF)(SN)(M)	P1091251		1-	A	C4
J 8958	CONNECTOR				40FLT-SM2-TB(LF)(SN)(M)	P1091251		1-	A	B4
J 8959	CONNECTOR				SB20-06WS	P0090613		2-	A	C6
JP8951	WIRE ASSY				AH036H 60MM9P	T9207507		1-	A	D2
Q 8951	IC				SN74HCT244PWR	G1094091		1-	A	C2
Q 8952	IC				BA05FP-E2	G1093209		1-	A	B1
Q 8953	FET				2SJ387STL	G3703878		1-	A	B2
Q 8954	TRANSISTOR				DTC114EUA T106	G3070084		1-	A	C2
Q 8955	TRANSISTOR				2SB1182-TLQ	G3070063		1-	A	A3
Q 8956	TRANSISTOR				2SA1576A T106 R	G3115768R		1-	A	B3
Q 8957	TRANSISTOR				2SC4081 T106	G3340818		1-	A	A3
Q 8958	TRANSISTOR				2SA1576A T106 R	G3115768R		1-	A	B3
Q 8960	TRANSISTOR				2SA1576A T106 R	G3115768R		1-	A	B3
Q 8961	TRANSISTOR				2SC4081 T106 R	G3340818R		2-	A	C6
R 8951	CHIP RES.	0	1/16W	5%	RMC1/16 000JATP	J24185000		1-	A	D1
R 8952	CHIP RES.	0	1/16W	5%	RMC1/16 000JATP	J24185000		1-	A	D1
R 8953	CHIP RES.	0	1/16W	5%	RMC1/16 000JATP	J24185000		1-	A	D1
R 8954	CHIP RES.	3.3	1W	5%	RMC1 3R3JTE	J24305339		1-	A	B2
R 8955	CHIP RES.	0	1/16W	5%	RMC1/16 000JATP	J24185000		1-	A	C2
R 8956	CHIP RES.	0	1/16W	5%	RMC1/16 000JATP	J24185000		1-	A	C2
R 8957	CHIP RES.	0	1/16W	5%	RMC1/16 000JATP	J24185000		1-	A	C2
R 8958	CHIP RES.	0	1/16W	5%	RMC1/16 000JATP	J24185000		1-	A	C2
R 8959	CHIP RES.	12	1W	5%	RMC1 120JTE	J24305120		1-	A	B2
R 8961	CHIP RES.	4.7k	1/16W	5%	RMC1/16 472JATP	J24185472		1-	A	B2
R 8962	CHIP RES.	0	1/16W	5%	RMC1/16 000JATP	J24185000		1-	A	C2
R 8963	CHIP RES.	4.7k	1/16W	5%	RMC1/16 472JATP	J24185472		1-	A	C2
R 8964	CHIP RES.	47k	1/16W	5%	RMC1/16 473JATP	J24185473		1-	A	B3
R 8965	CHIP RES.	47k	1/16W	5%	RMC1/16 473JATP	J24185473		1-	A	B3
R 8966	CHIP RES.	22k	1/16W	5%	RMC1/16 223JATP	J24185223		1-	A	B3
R 8967	CHIP RES.	12k	1/16W	5%	RMC1/16 123JATP	J24185123		1-	A	A3
R 8968	CHIP RES.	4.7k	1/16W	5%	RMC1/16 472JATP	J24185472		1-	A	A3
R 8969	CHIP RES.	47k	1/16W	5%	RMC1/16 473JATP	J24185473		1-	A	B3
R 8970	CHIP RES.	22k	1/16W	5%	RMC1/16 223JATP	J24185223		1-	A	B3
R 8971	CHIP RES.	0	1/16W	5%	RMC1/16 000JATP	J24185000		1-	A	B3
R 8972	CHIP RES.	22k	1/16W	5%	RMC1/16 223JATP	J24185223		1-	A	B3
R 8973	CHIP RES.	1.8k	1/16W	5%	RMC1/16 182JATP	J24185182		1-	A	B3
R 8977	CHIP RES.	1k	1/16W	5%	RMC1/16 102JATP	J24185102		2-	A	C6
R 8978	CHIP RES.	0	1/16W	5%	RMC1/16 000JATP	J24185000		2-	A	C6
R 8980	CHIP RES.	0	1/16W	5%	RMC1/16 000JATP	J24185000		2-	A	C6
R 8980	CHIP RES.	10	1/16W	5%	RMC1/16 100JATP	J24185100		8-	A	C6

LINK Unit

Note:



Copyright 2010
VERTEX STANDARD CO., LTD.
All rights reserved

No portion of this manual
may be reproduced without
the permission of
VERTEX STANDARD CO., LTD.